

MILANO 2024

Poliform

Poliform



MILANO 2024



Da sempre Poliform esprime una visione evoluta dell'interior design, ispirata all'architettura contemporanea e alla ricerca sui nuovi modi dell'abitare. Al Salone del Mobile.Milano 2024, cui è dedicato questo volume, Poliform ha presentato le novità di prodotto firmate dai designer Jean-Marie Massaud, Emmanuel Gallina e Stefano Belingardi Clusoni, accanto ai best seller e a numerosi ampliamenti di gamma. In dialogo tra loro e con l'architettura dello stand, i prodotti raccontano il progetto di stile Poliform con un'estetica coerente e riconoscibile, declinata in chiave lifestyle.

Since its inception, Poliform has had a forward-looking take on interior design, getting inspired by contemporary architecture and always keeping up to date on new ways of living. At Salone del Mobile.Milano 2024, to which this catalogue is dedicated, Poliform presented new products by designers Jean-Marie Massaud, Emmanuel Gallina and Stefano Belingardi Clusoni, together with their best sellers and new additions to their ranges. These products are in dialogue with one another and with the architectural set-up of the stand, and illustrate the Poliform-style project through coherent and recognizable aesthetics, from a lifestyle perspective.





Poliform presenta in anteprima le novità 2024. Con il divano Ernest, Jean-Marie Massaud interpreta il tema del comfort in modo radicale, con volumi morbidi e destrutturati. Un'estetica forte e d'impatto, ma sempre elegante, che si riconosce anche nei tavolini Ernest, nel tavolo Adrien, nella poltrona Kaori Lounge, nelle madie Duke e nella collezione notte Brera, mentre la sedia Ipanema, la poltroncina Leopold e la madia Aiko si rifanno a linee più essenziali. Forme organiche e curve delicate si confermano la cifra stilistica di Emmanuel Gallina, che con i divani Orbis e i tavolini Strata disegna un living più intimo, quasi uno spazio nello spazio. Stefano Belingardi Clusoni progetta una poltroncina per il low dining che unisce solidità e morbidezza. A completare la proposta è l'R&D Poliform, che firma le più recenti evoluzioni dei sistemi giorno.

Poliform presents a preview of what's new in 2024. With the Ernest sofa, Jean-Marie Massaud approaches the theme of comfort in a radical way, with soft, unstructured volumes. A strong and impactful, yet still elegant aesthetic is also on display in the Ernest side tables, the Adrien table, the Kaori Lounge armchair, the Duke sideboards and the Brera night collection, while the Ipanema chair, the Leopold small armchair and the Aiko sideboard feature more essential lines. Organic shapes and delicate curves are the stylistic signature of Emmanuel Gallina, who designed a more intimate living room, with the Orbis sofas and Strata coffee tables. You could say, a space within a space. Stefano Belingardi Clusoni designed a low dining armchair that combines solidity and softness. Poliform R&D completes the offer, designing the latest living room systems evolutions.

COLLECTIONS	ERNEST SOFA	15
	ERNEST COFFEE TABLE	59
	LOAI ARMCHAIR	73
	ORBIS SOFA COLLECTION	91
	STRATA COFFEE TABLE	117
	KAORI LOUNGE ARMCHAIR	133
	DUKE SIDEBOARD	145
	AIKO SIDEBOARD	169
	ADRIEN TABLE	179
	LEOPOLD CHAIR	205
	IPANEMA CHAIR	219
	CURVE STOOL	233
	BRERA NIGHT COLLECTION	243
	KETCH OUTDOOR SUNBED	269
	CODE DAY SYSTEM	281
	WALL SYSTEM	295
	TRACE CARPET	325
	NEW INDOOR FABRICS	331
SOFA COMPOSITIONS	ERNEST SOFA	338
	ORBIS SOFA	378
TECHNICAL DATA	INDOOR FINISHINGS	391



ERNEST SOFA

Con Ernest, Jean-Marie Massaud interpreta il tema del comfort in modo radicale. Il risultato di questo approccio, che fa della modularità un punto di forza, è un divano dai volumi morbidi e destrutturati ispirati a un cuscino in piuma, per un comfort naturale. Accostando i diversi elementi si creano divani piccoli o grandi, lineari o a L, senza mai perdere la forza espressiva del progetto.

With Ernest, Jean-Marie Massaud tackles the theme of comfort in a radical way. The result of this approach, which makes modularity its strong point, is a sofa with soft, deconstructed volumes inspired by a down cushion for natural comfort. The juxtaposition of the different elements results in small or large, linear or L-shaped sofas, without ever losing the expressive power of the design.

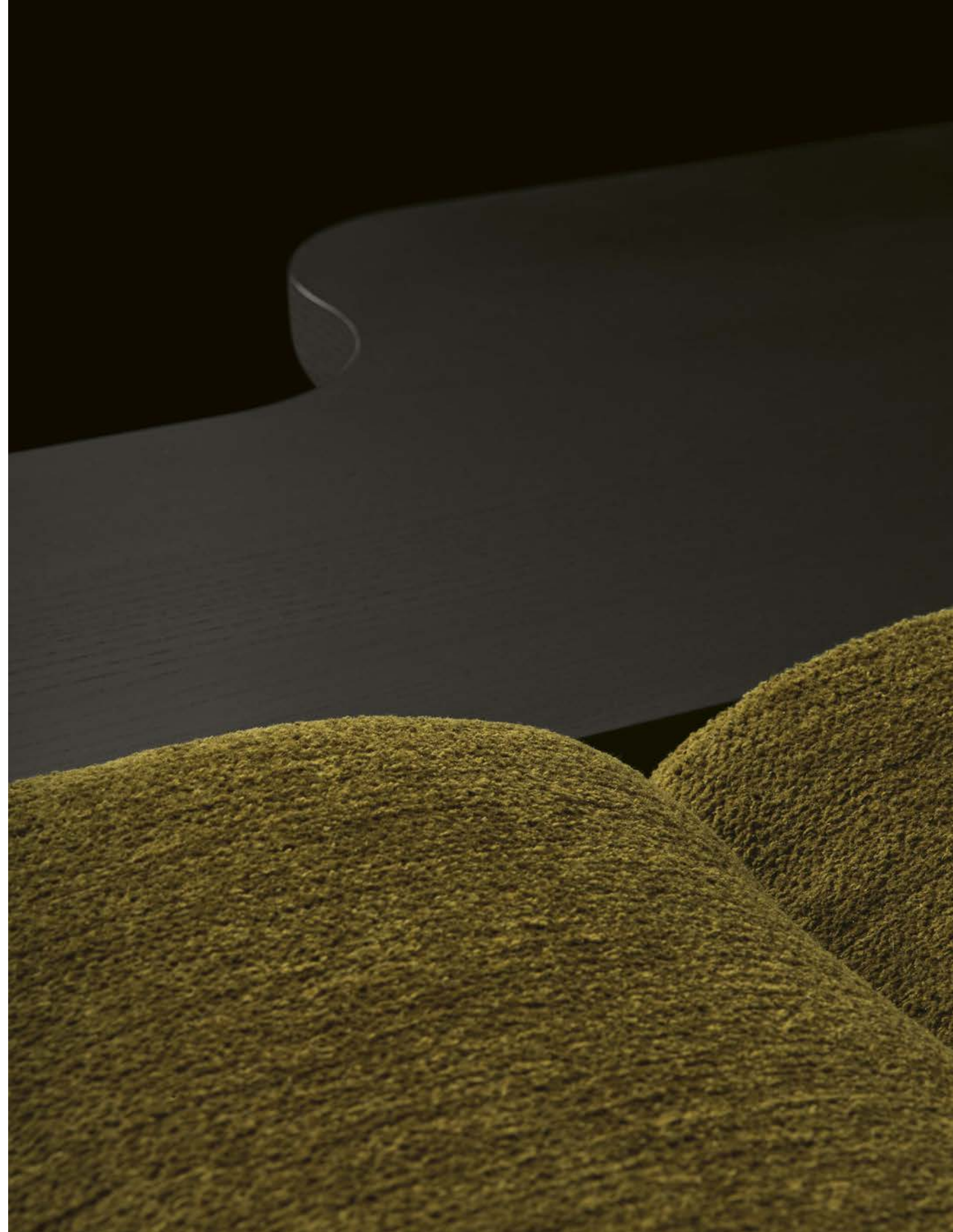

In questa pagina e nella successiva: divano Ernest con rivestimento sfoderabile in tessuto Shedir 06 oliva, tavolini Ernest in olmo nero e in marmo travertino titanium levigato. Tappeto Trace white. A destra: porte Pivot Side in vetro Rain écreu con telaio in olmo nero e maniglia Side ardesia opaco. Portale in laccato metallico bronzo e stipite ardesia opaco.

This and next page: Ernest sofa with removable cover in fabric Shedir 06 oliva, Ernest coffee tables in black elm and in mat marble travertino titanium. Carpet Trace white. Right: Pivot Side doors in glass Rain écreu with black elm frame and mat ardesia Side handle. Portal in metallic lacquer bronze and mat ardesia jamb.







In questa pagina: poltrona Ernest con rivestimento sfoderabile in tessuto Shedir 06 oliva, tavolini Ernest in marmo travertino titanium levigato. Nella pagina successiva: divano Ernest con rivestimento sfoderabile in tessuto Shedir 06 oliva, tavolini Ernest in olmo nero e in marmo travertino titanium levigato. Tappeto Trace white.

This page: Ernest armchair with removable cover in fabric Shedir 06 oliva, Ernest coffee tables in mat marble travertino titanium. Next page: Ernest sofa with removable cover in fabric Shedir 06 oliva, Ernest coffee tables in black elm and in mat marble travertino titanium. Carpet Trace white.





Nella pagina precedente: divano Ernest con rivestimento sfoderabile in tessuto Shedir 06 oliva, tavolino terminale in olmo nero. In questa pagina: poltrona e pouf Ernest con rivestimento sfoderabile in pelle Nabuk 01 latte. Tavolini Ernest in marmo travertino classico levigato e in laccato lucido liquirizia. Tappeto Trace white.

Previous page: Ernest sofa with removable cover in fabric Shedir 06 oliva, end coffee table in black elm. This page: Ernest armchair and pouf with removable cover in leather Nabuk 01 latte. Ernest coffee tables in mat marble travertino classico and in glossy lacquer liquirizia. Carpet Trace white.







Nella pagina precedente: divano Ernest con rivestimento sfoderabile in velluto Glasgow 01 crema, tavolini terminali in marmo travertino classico levigato. Divano Ernest con rivestimento sfoderabile in pelle Nabuk 01 latte, tavolino retrodivano in marmo travertino classico levigato. Al centro, tavolini Ernest in laccato lucido liquirizia. Tappeto Trace white. In questa pagina: divano Ernest con rivestimento sfoderabile in pelle Nabuk 01 latte.

Previous page: Ernest sofa with removable cover in velvet Glasgow 01 crema, end coffee tables in mat marble travertino classico. Ernest sofa with removable cover in leather Nabuk 01 latte, sofa rear table in mat marble travertino classico. In the middle, Ernest coffee tables in glossy lacquer liquirizia. Carpet Trace white. This page: Ernest sofa with removable cover in leather Nabuk 01 latte.

In questa pagina e nella successiva: divano Ernest con rivestimento sfoderabile in velluto Glasgow 01 crema, tavolino retrodivano in olmo nero.

This and next page: Ernest sofa with removable cover in velvet Glasgow 01 crema, sofa rear table in black elm.







Nella pagina precedente: divano Ernest con rivestimento sfoderabile in pelle Natural 10 nero, tavolino terminale in olmo nero. Tavolini Ernest in laccato lucido liquirizia; al centro, in marmo travertino titanium levigato. Poltrone Ernest con rivestimento sfoderabile in tessuto Shedir 01 avorio. Libreria Lexington con montanti a soffitto in ardesia opaco con piedini di regolazione in nickel ardesia. Ripiani in olmo nero e ardesia opaco con luce a led integrata dimmerabile, ripiani in vetro fumé. Tappeto Trace white. In questa pagina: poltrone Ernest con rivestimento sfoderabile in tessuto Shedir 01 avorio e tavolino Ernest in laccato lucido liquirizia.

Previous page: Ernest sofa with removable cover in leather Natural 10 nero, end coffee table in black elm. Ernest coffee tables in glossy lacquer liquirizia; in the middle, in mat marble travertino titanium. Ernest armchairs with removable cover in fabric Shedir 01 avorio. Lexington bookcase with floor-ceiling uprights in mat ardesia with levelling feet in nickel ardesia. Shelves in black elm and mat ardesia with dimmable integrated led light, shelves in fumé glass. Carpet Trace white. This page: Ernest armchairs with removable cover in fabric Shedir 01 avorio and Ernest coffee table in glossy lacquer liquirizia.







Nella pagina precedente: divano Ernest con rivestimento sfoderabile in pelle Natural 10 nero, tavolino terminale in olmo nero. Tavolino Ernest in laccato lucido liquirizia; al centro, in marmo travertino titanium levigato. Tappeto Trace white. In questa pagina e nella successiva: divano Ernest con rivestimento sfoderabile in pelle Natural 10 nero, tavolino retrodivano in olmo nero.

Previous page: Ernest sofa with removable cover in leather Natural 10 nero, end coffee table in black elm. Ernest coffee table in glossy lacquer liquirizia; in the middle, in mat marble travertino titanium. Carpet Trace white. This and next page: Ernest sofa with removable cover in leather Natural 10 nero, sofa rear table in black elm.



In questa pagina e nella successiva: divano Ernest con rivestimento sfoderabile in tessuto Shedir 03 perla, tavolino ad angolo in olmo nero.

This and next page: Ernest sofa with removable cover in fabric Shedir 03 perla, corner coffee table in black elm.





In questa pagina e nella successiva: poltrone Ernest con rivestimento sfoderabile in pelle Nabuk 06 mastice.

This and next page: Ernest armchairs with removable cover in leather Nabuk 06 mastice.





ERNEST

Design Jean-Marie Massaud

Divano componibile con struttura in legno e derivati e poliuretano flessibile stampato monoquota con inserto in piuma o fibra di poliestere in corrispondenza della seduta e dello schienale. Piedini in materiale plastico. Rivestimento sfoderabile in tessuto o pelle. Tavolini con gambe in massello, finitura olmo nero, laccato opaco colori, laccato lucido colori o in marmo levigato travertino classico e travertino titanium. Piano in olmo nero, laccato opaco colori, laccato lucido colori o in marmo levigato travertino classico e travertino titanium.

Modular sofa with structure in wood and wood-derivatives and in single-density flexible moulded polyurethane, insert in down or polyester fibre at the seat cushion and the backrest. Feet in plastic material. Removable cover in fabric or leather. Coffee tables with legs in solid wood, finishes black elm, mat lacquered colours, glossy lacquered colours or in mat marble travertino classico and travertino titanium. Top in black elm, mat lacquered colours, glossy lacquered colours or in mat marble travertino classico and travertino titanium.

Elemento I 900 Element w 35 1/2"

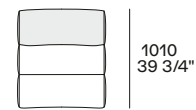
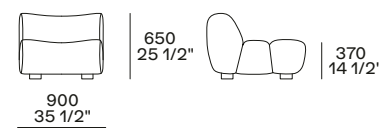

ad uso poltrona
used as armchair

Il divano è disponibile in due altezze:
- h 650, seduta h 370, con piedino arretrato di serie h 60.
- h 670, seduta h 390, con piedino arretrato opzionale h 80.

The sofa is available in two heights:
- h 25 1/2", seat h 14 1/2", with standard recessed feet h 2 1/4".
- h 26 1/2", seat h 15 1/4", with optional recessed feet h 3 1/4".

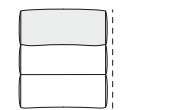

ad uso terminale sx-dx
used as lt-rt end unit

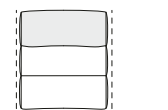

ad uso centrale
used as central unit

Bracciolo Armrest

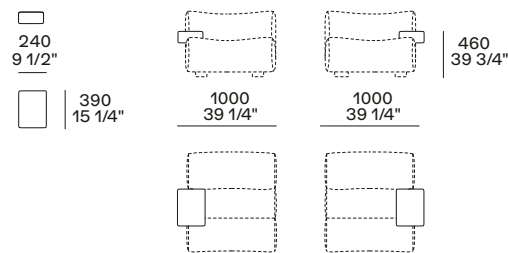

bracciolo terminale sx-dx, sporgenza 100
lt-rt end armrest, protrusion 4"

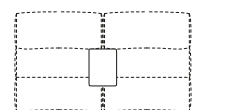

bracciolo tra due elementi
armrest between two elements

Tavolini Coffee tables

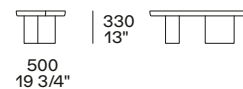

terminale sx
lt end unit

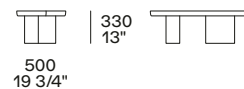

terminale dx
rt end unit

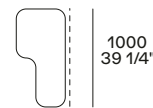

terminale sx
lt end unit

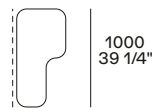

terminale dx
rt end unit

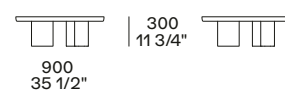

ad uso angolo o terminale
used as corner unit or end unit

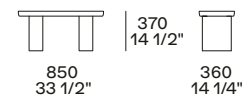

uso retrodivano,
da accostare al pouf
I 900 p 690
used as sofa rear table,
to be placed next to the
pouf w 35 1/2" d 27 1/4"



ad uso centrale
used as central unit

Elementi inclinati Angled elements

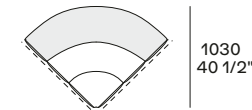
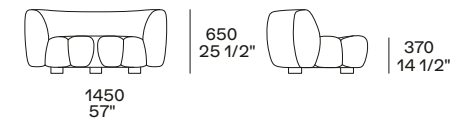

ad uso angolo
used as corner unit

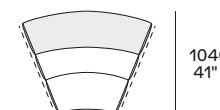
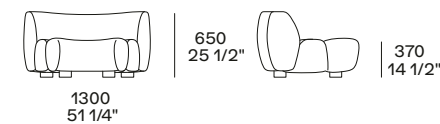

ad uso centrale
used as central unit

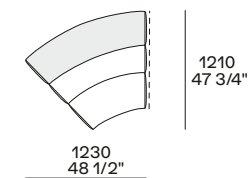

ad uso terminale sx-dx
used as lt-rt end unit

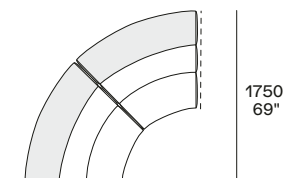

ad uso angolo
used as corner unit

Pouf Pouf

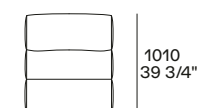
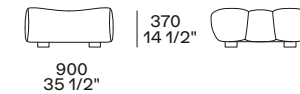

ad uso centrostanza
used as freestanding

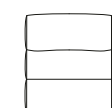

ad uso terminale sx-dx
used as lt-rt end unit

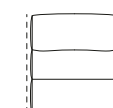

ad uso centrale
used as central unit

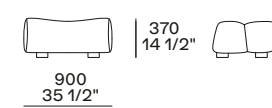

da accostare al tavolino retrodivano o
come pouf poggiapiedi per uso chaise longue
to be placed next to the sofa rear table
or as footstool for chaise longue use

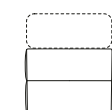

ad uso terminale sx-dx
used as lt-rt end unit

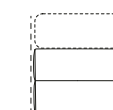

ad uso centrale
used as central unit

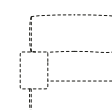

ad uso chaise longue
used as chaise longue

NB

Divano con giunzioni laterali, liberamente aggregabile.
Sofa with side joints, allowing combination freedom.



ERNEST COFFEE TABLE

Dell'omonima collezione di divani, i tavolini Ernest riprendono ed espandono il tema della modularità. Come un puzzle, i tavolini possono essere combinati tra loro a centro stanza per creare figure che rendono dinamica la zona living, oppure usati singolarmente accanto al divano Ernest.

Starting from the sofas, the Ernest side tables return to and expand on the theme of modularity. Just like a puzzle, the coffee tables can be combined in the middle of the room to make the living area more dynamic, or used individually next to the Ernest sofa.





In questa pagina: tavolini Ernest in laccato lucido liquirizia. Divano Ernest con rivestimento sfoderabile in velluto Glasgow 01 crema, tavolino terminale in marmo travertino classico levigato. Tappeto Trace white. Nella pagina successiva: tavolini Ernest in olmo nero e in marmo travertino titanium levigato.

This page: Ernest coffee tables in glossy lacquer liquirizia. Ernest sofa with removable cover in velvet Glasgow 01 crema, end coffee table in mat marble travertino classico. Carpet Trace white. Next page: Ernest coffee tables in black elm and in mat marble travertino titanium.



In questa pagina: tavolini Ernest in marmo travertino titanium levigato.
Divano Ernest con rivestimento sfoderabile in tessuto Shedir 06 oliva.
Tappeto Trace white.

This page: Ernest coffee tables in mat marble travertino titanium.
Ernest sofa with removable cover in fabric Shedir 06 oliva. Carpet
Trace white.



In questa pagina e nella successiva: tavolini Ernest in marmo travertino titanium levigato e in olmo nero.

This and next page: Ernest coffee tables in mat marble travertino titanium and in black elm.





ERNEST

Design Jean-Marie Massaud

Tavolini con piano e gambe in laccato opaco colori, laccato lucido colori, in olmo nero (gambe in massello finitura olmo nero) o in marmo levigato travertino classico e travertino titanium.

Coffe tables with top and legs in mat lacquered colours, glossy lacquered colours, in black elm (legs in solid wood finish black elm) or in mat marble travertino classico and travertino titanium.

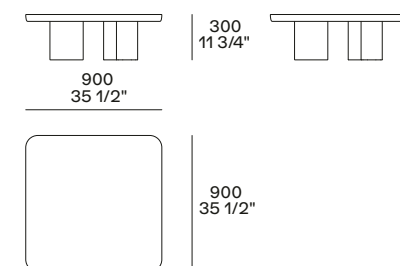
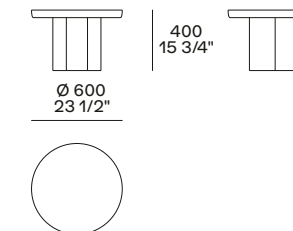
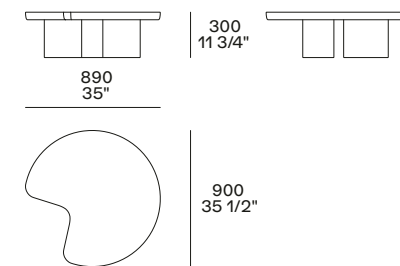
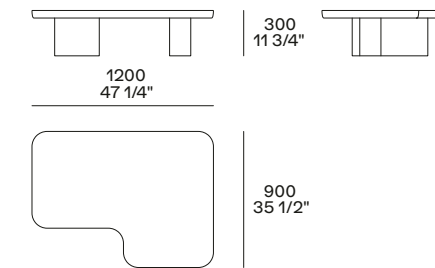
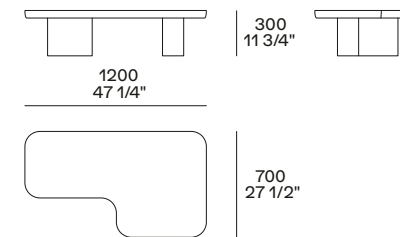



LOAI ARMCHAIR

Loai è una poltrona nata dal dialogo tra mondo del progetto e mondo del design. La struttura a vista riprende la classica forma a compasso, mentre lo schienale è avvolgente. Primo prodotto dell'architetto Stefano Belingardi Clusoni per Poliform, Loai è una poltrona per il low dining, basata sul contrasto fra dimensioni compatte e seduta extra large, solidità della struttura e morbidezza della cuscinatura, modernismo e contemporaneità.

Loai is the first product by architect Stefano Belingardi Clusoni for Poliform, an armchair born from the dialogue between architecture and design. The exposed frame echoes the classic compass shape, while the backrest is enveloping. An armchair made for low dining, Loai highlights the contrast between its compact size and extra-large seat, firm structure and soft cushioning, modernism and contemporaneity.



In questa pagina e nella successiva: poltrone Loai con rivestimento sfoderabile in pelle Natural 06 naturale e struttura in olmo nero. Tavolino Orbit, piano e struttura in vetro bronzato, struttura in vetro soffiato. Divano Saint-Germain con rivestimento sfoderabile in tessuto Siro 01 bianco, cuscini in tessuto Mintaka 02 sabbia e in velluto Persia 03 perla, piedini brown nickel opaco. Tavolino Saint-Germain con piano in olmo nero e struttura brunito opaco. Tavolini Koishi, accanto al divano, con piano in olmo nero e struttura brunito opaco; al centro, con piani in marmo zecevo levigato e struttura brunito opaco. Tappeto Shindo natural.

This and next page: Loai armchairs with removable cover in leather Natural 06 naturale and structure in black elm. Orbit coffee table, top and structure in bronzed glass, structure in blown glass. Saint-Germain sofa with removable fabric Siro 01 bianco, cushions in fabric Mintaka 02 sabbia and in velvet Persia 03 perla, mat brown nickel feet. Saint-Germain coffee table with top in black elm and mat brunito structure. Koishi coffee table, next to the sofa, with top in black elm and mat brunito structure; in the middle, with tops in mat marble zecevo and mat brunito structure. Carpet Shindo natural.







In questa pagina: poltrona Loai con rivestimento sfoderabile in pelle Natural 06 naturale e struttura in olmo nero. Tavolino Orbit, piano e struttura in vetro bronzato, struttura in vetro soffiato. Tappeto Shindo natural.

This page: Loai armchair with removable cover in leather Natural 06 naturale and structure in black elm. Orbit coffee table, top and structure in bronzed glass, structure in blown glass. Carpet Shindo natural.

In questa pagina: poltrona Loai con rivestimento sfoderabile in velluto Persia 1402 muschio e struttura in olmo nero. Nelle pagine successive: poltrone Loai con rivestimento sfoderabile in tessuto Altair 06 senape e in pelle Soft 02 mastice, struttura in olmo nero.

This page: Loai armchair with removable cover in velvet Persia 1402 muschio and structure in black elm. Next pages: Loai armchairs with removable cover in fabric Altair 06 senape and in leather Soft 02 mastice, structure in black elm.









LOAI

Design Stefano Belingardi Clusoni

Poltrona con struttura in massello finitura olmo nero o rovere spessart.
Cuscino seduta e schienale in polimex con imbottitura in poliuretano a quote differenziate. Prerivestimento in tela cotone.
Rivestimento sfoderabile in tessuto o pelle.

Armchair with structure in solid wood finishes black elm or spessart oak.
Seat cushion and backrest in polimex with padding in polyurethane in differentiated densities. Pre-cover in cotton canvas.
Removable cover in fabric or leather.

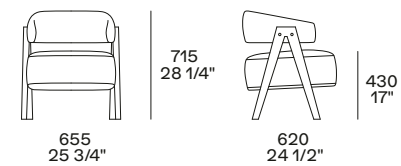

ORBIS SOFA COLLECTION

Con le sue linee curve e le forme morbide, Orbis disegna all'interno del living uno spazio intimo e accogliente. La collezione si compone di due divani e una poltrona dallo schienale avvolgente, perfetta sintesi tra design moderno e tecnologia contemporanea. Sia nei divani che nella poltrona la seduta, sollevata da terra da un piedino sottile ispirato alle lavorazioni della gioielleria, è confortevole e invita alla conversazione.

With its curved lines and soft forms, Orbis designs an intimate and cosy space within the living room. The collection consists of two sofas and an armchair with an enveloping backrest, a perfect synthesis of modern design and contemporary technology. In both the sofas and the armchair, the seat, raised off the ground by a thin leg inspired by jewelry workmanship, is comfortable and invites conversation.

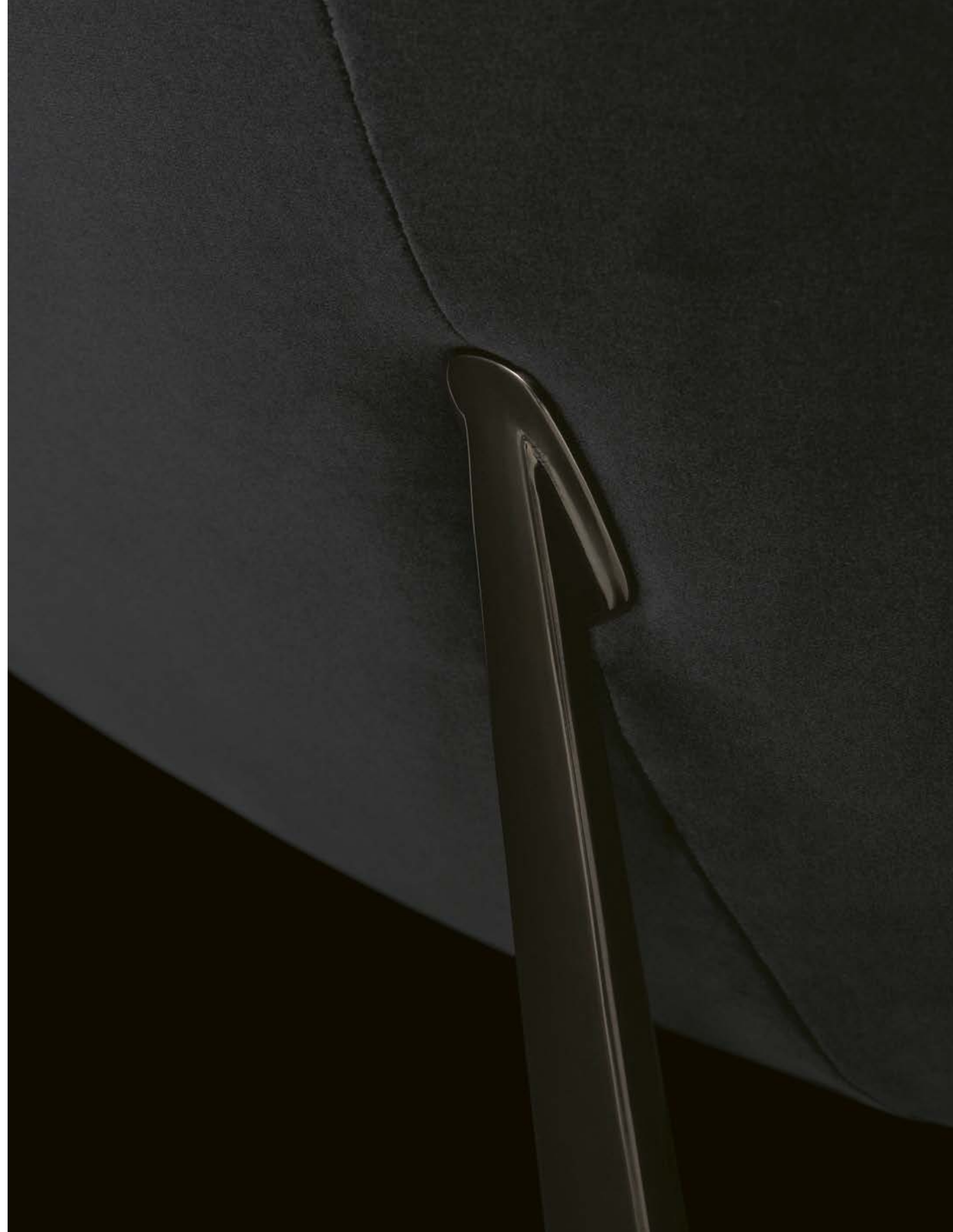



In questa pagina e nelle successive: divano Orbis con rivestimento sfoderabile in tessuto Altair 10 avio, cuscini opzionali in velluto Polar 10 avio, piedini in metallo dark sheer lucido. Poltrona Orbis con rivestimento sfoderabile in tessuto Mintaka 02 sabbia e piedini in metallo dark sheer lucido. Tavolini Strata, accanto al divano, in marmo travertino classico levigato; al centro, con piano in vetrofusione bronzo e gambe in olmo nero. Tappeto Shindo natural.

This and next pages: Orbis sofa with removable cover in fabric Altair 10 avio, optional cushions in velvet Polar 10 avio, feet in glossy metal dark sheer. Orbis armchair with removable cover in fabric Mintaka 02 sabbia and feet in glossy metal dark sheer. Strata coffee tables, next to the sofa in mat marble travertino classico; in the middle, top in fused glass bronze and legs in black elm. Carpet Shindo natural.







Nella pagina precedente: divano Orbis con rivestimento sfoderabile in velluto Persia 1404 carbone, cuscini opzionali in tessuto Mizar 04 fango, piedini in metallo dark sheer lucido. In questa pagina: poltrona Orbis con rivestimento sfoderabile in tessuto Mintaka 02 sabbia e piedini in metallo dark sheer lucido. Tavolino Strata in marmo travertino classico levigato. Madia Duke laccato lucido liquirizia con ante battenti, struttura interna in rovere bianco. Tappeto Shindo natural.

Previous page: Orbis sofa with removable cover in velvet Persia 1404 carbone, optional cushions in fabric Mizar 04 fango, feet in glossy metal dark sheer. This page: Orbis armchair with removable cover in fabric Mintaka 02 sabbia and feet in glossy metal dark sheer. Strata coffee table in mat marble travertino classico. Glossy lacquer liquirizia Duke sideboard with leaf doors, inner structure in white oak. Carpet Shindo natural.





In questa pagina: dettaglio della poltrona Orbis con rivestimento sfoderabile in tessuto Mintaka 03 pepe. Nella pagina successiva: poltrone Orbis, a sinistra con rivestimento sfoderabile in pelle Natural 10 nero e piedini in metallo dark sheer lucido; a destra con rivestimento sfoderabile in tessuto Mintaka 03 pepe e piedini in metallo dark sheer opaco.

This page: close up of the Orbis armchair with removable cover in fabric Mintaka 03 pepe. Next page: Orbis armchairs, to the left with removable cover in leather Natural 10 nero and feet in glossy metal dark sheer; to the right with removable cover in fabric Mintaka 03 pepe and feet in mat metal dark sheer.



ORBIS ARMCHAIR





Nella pagina precedente: divano Orbis con rivestimento sfoderabile in tessuto Hamal 01 panna, cuscini opzionali in tessuto Mintaka 02 sabbia, piedini in metallo dark sheer lucido. Poltrona Orbis con rivestimento sfoderabile in pelle Suede 05 cammello e piedini in metallo dark sheer lucido. Tavolino Strata in marmo travertino classico levigato. Tappeto Shindo natural. In questa pagina: dettaglio del divano Orbis con rivestimento sfoderabile in tessuto Altair 03 tortora, piedini in metallo dark sheer lucido.

Previous page: Orbis sofa with removable cover in fabric Hamal 01 panna, optional cushions in fabric Mintaka 02 sabbia, feet in glossy metal dark sheer. Orbis armchair with removable cover in leather Suede 05 cammello and feet in glossy metal dark sheer. Strata coffee table in mat marble travertino classico. Carpet Shindo natural. This page: close up of the Orbis sofa with removable cover in fabric Altair 03 tortora, feet in glossy metal dark sheer.





In questa pagina: divano Orbis con rivestimento sfoderabile in tessuto Altair 03 tortora, cuscino opzionale in velluto Persia 1404 carbone, piedini in metallo dark sheer lucido.

This page: Orbis sofa with removable cover in fabric Altair 03 tortora, optional cushion in velvet Persia 1404 carbone, feet in glossy metal dark sheer.

ORBIS

Design Emmanuel Gallina

Struttura in metallo e poliuretano flessibile monoquota, seduta in poliuretano flessibile a quote differenziate, prriverestimento in tela cotone.

Cuscino schienale per divano in poliuretano flessibile con prriverestimento in tela cotone e piuma. Cuscino schienale per poltrona e cuscino opzionale per divano in tela cotone e piuma.

Piedini in metallo verniciato opaco e lucido light sheer o dark sheer.

Rivestimento sfoderabile in tessuto o pelle.

Structure in metal and flexible single-density polyurethane, seat in flexible polyurethane with differentiated densities, pre-cover in cotton canvas.

Backrest cushion for sofa in flexible polyurethane with pre-cover in cotton canvas and down. Backrest cushion for armchair and optional cushion for sofa in cotton canvas and down.

Feet in glossy and mat painted metal light sheer or dark sheer.

Removable cover in fabric or leather.

Divano Sofa

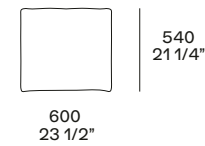
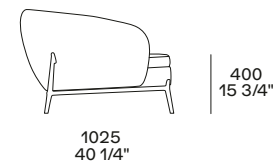
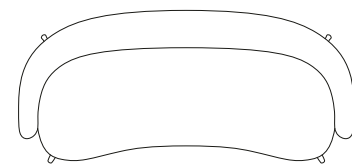
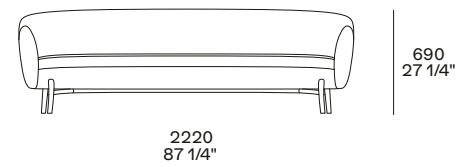

cuscino schienale
backrest cushion

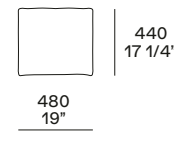

cuscino opzionale
optional cushion

Cuscinatura consigliata Recommended cushions

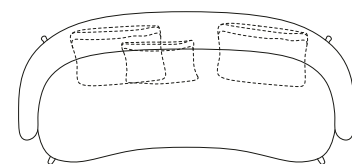
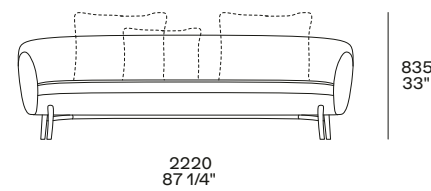

2 cuscini schienale, 1 cuscino opzionale
2 backrest cushions, 1 optional cushion

Poltrona Armchair

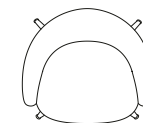
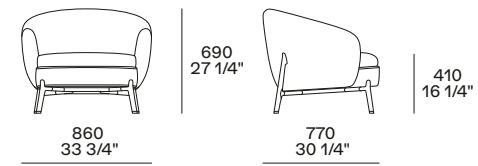

410
16 1/4"

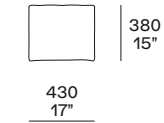

cuscino schienale
backrest cushion

Divano inclinato Angled sofa

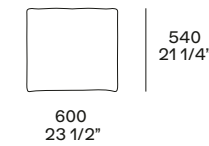
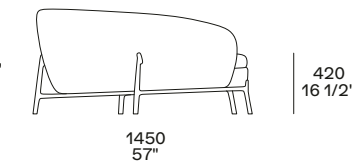
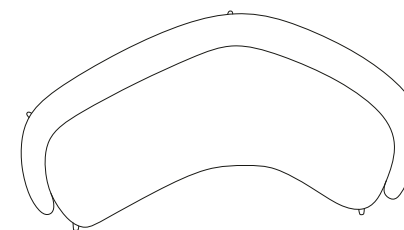
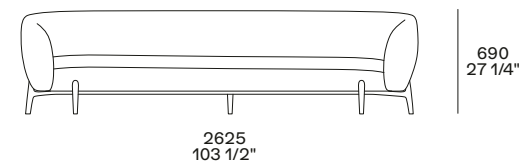

cuscino schienale
backrest cushion

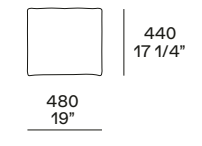

cuscino opzionale
optional cushion

Cuscinatura consigliata Recommended cushions

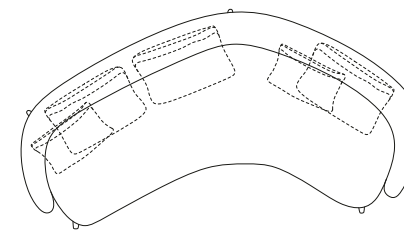
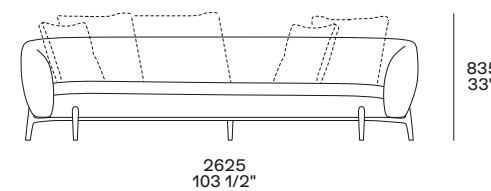

3 cuscini schienale, 2 cuscini opzionali
3 backrest cushions, 2 optional cushions

STRATA COFFEE TABLE

Nato come tavolino outdoor, Strata viene ora reinterpretato in chiave indoor, con gambe in olmo nero e piani in marmo e vetro, cui si aggiunge una versione interamente in travertino dall'aspetto scultoreo. Disponibile in diverse dimensioni e altezze, con piani rotondi o di forme organiche, Strata esprime una peculiare unicità, abbinandosi a tutti i divani della collezione.

Originally created as an outdoor coffee table, Strata is now reinterpreted for indoor use, with black elm legs and a marble and glass top, in addition to a sculptural-looking travertine version. Available in different sizes and heights, with round or organically shaped tops, Strata exudes a peculiar uniqueness, matching all the sofas in the collection.

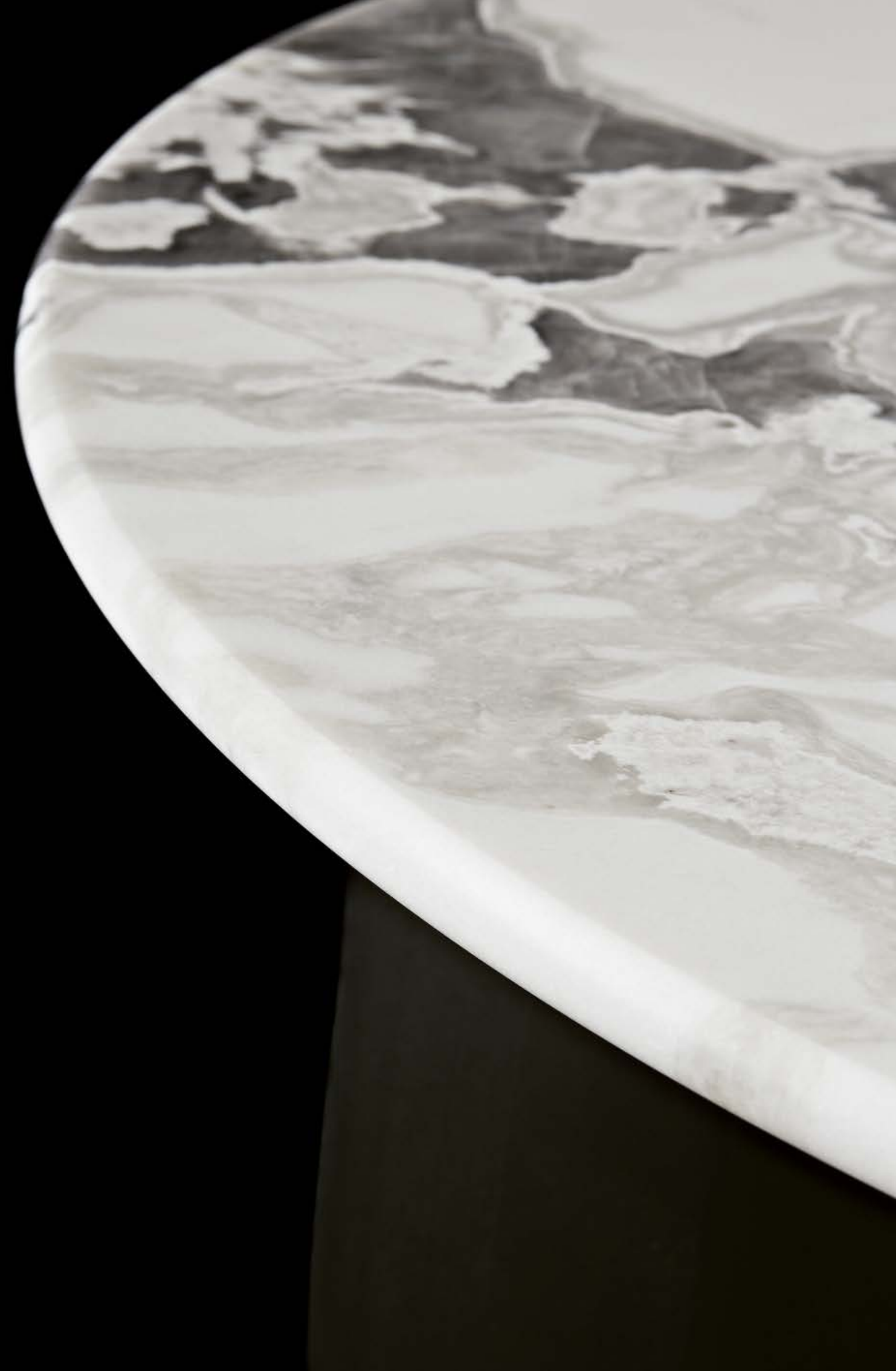

In questa pagina: divano Orbis con rivestimento sfoderabile in tessuto Altair 10 avio, cuscini opzionali in velluto Polar 10 avio, piedini in metallo dark sheer lucido. Tavolini Strata con piano in vetrofusione bronzo e gambe in olmo nero. Tappeto Shindo natural.

This page: Orbis sofa with removable cover in fabric Altair 10 avio, optional cushions in velvet Polar 10 avio, feet in glossy metal dark sheer. Strata coffee tables with top in fused glass bronzo and legs in black elm. Carpet Shindo natural.





Nella pagina precedente: tavolini Strata, da sinistra, piano in vetrofusione bronzo e gambe in olmo nero; piano in marmo oyster white levigato e gambe in olmo nero; piano e gamba in olmo nero. In questa pagina: dettaglio dei top in olmo nero e in vetrofusione fumé.

Previous page: Strata coffee tables, from the left, top in fused glass bronzo and legs in black elm; top in mat marble oyster white and legs in black elm; top and leg in black elm. This page: close up of the top in black elm and in fused glass fumé.





In questa pagina: tavolini Strata, da sinistra, piano in vetrofusione fumé e gambe in olmo nero; piano e gambe in olmo nero.

This page: Strata coffee tables, from the left, top in fumé fused glass and legs in black elm; top and legs in black elm.

In questa pagina: dettaglio del tavolino Strata in marmo travertino classico levigato. Nella pagina successiva: tavolini Strata, da sinistra, tavolino in marmo travertino classico levigato; piano in vetrofusione fumé e gamba in olmo nero; piano e gamba in olmo nero.

This page: close up of the Strata coffee table in mat marble travertino classico. Next page: Strata coffee tables, from the left, coffee table in mat marble travertino classico; top in fumé fused glass and leg in black elm; top and leg in black elm.



STRATA

Design Emmanuel Gallina

Tavolini con piano in olmo nero e gambe in massello finitura olmo nero o con piano e gambe in marmo levigato travertino classico. Piano in marmo levigato e lucido (escluso emperador dark e travertino titanium) e gambe in massello finitura olmo nero disponibile solo per tavolini 1300x900 e Ø 1000. Piano in vetrofusione fumé o bronzo con distanziale in acciaio inox verniciato brown nickel opaco e gambe in massello finitura olmo nero.

Coffe tables with top in black elm and legs in solid wood finish black elm or with top and legs in mat marble travertino classico. Top in mat and glossy marble (except emperador dark and travertino titanium) and legs in solid wood finish black elm available only for coffe tables 54 3/4" x35 1/2" and Ø 39 1/4". Top in fused glass fumé or bronzo with spacer in stainless steel painted mat brown nickel and legs in solid wood finish black elm.

Piano in legno o marmo Top in wood or marble

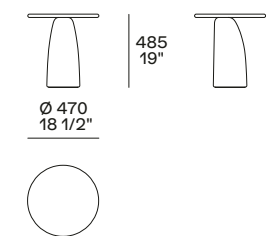
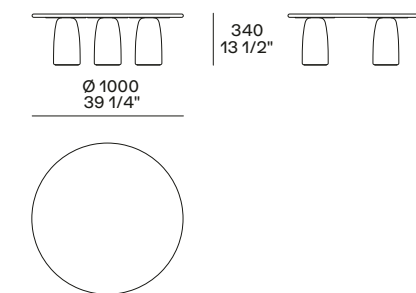
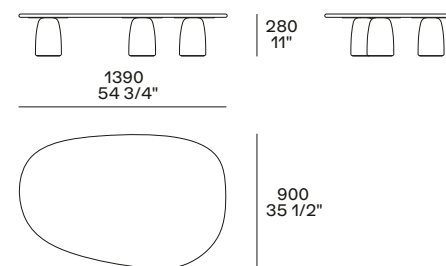

Piano in vetro Top in glass

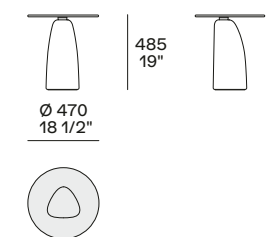
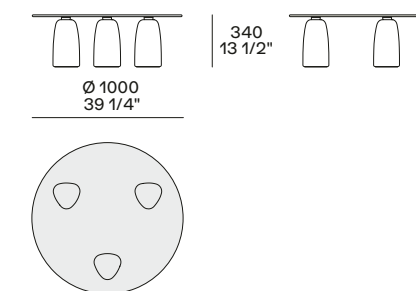
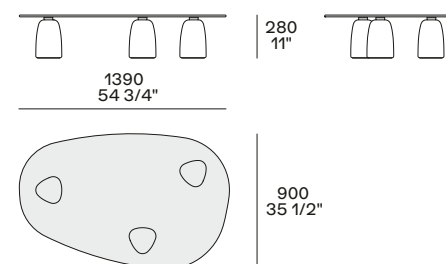

KAORI LOUNGE ARMCHAIR

Linee morbide, forme avvolgenti e volumi ancora più generosi per la poltrona Kaori, che Jean-Marie Massaud reinterpreta in una nuova versione con schienale alto. La poltrona, anche con meccanismo girevole, si caratterizza per la perfetta integrazione tra scocca esterna in cuoio e scocca interna, imbottita e rivestita. Per il massimo comfort è disponibile il pouf coordinato.

Soft lines, enveloping shapes and even more generous volumes for the Kaori armchair, which Jean-Marie Massaud reinterprets in a new version with a high backrest. The armchair, also featuring a swivel mechanism, is characterized by the perfect integration of hide outer shell and padded and upholstered inner shell. A matching pouf is available for maximum comfort.

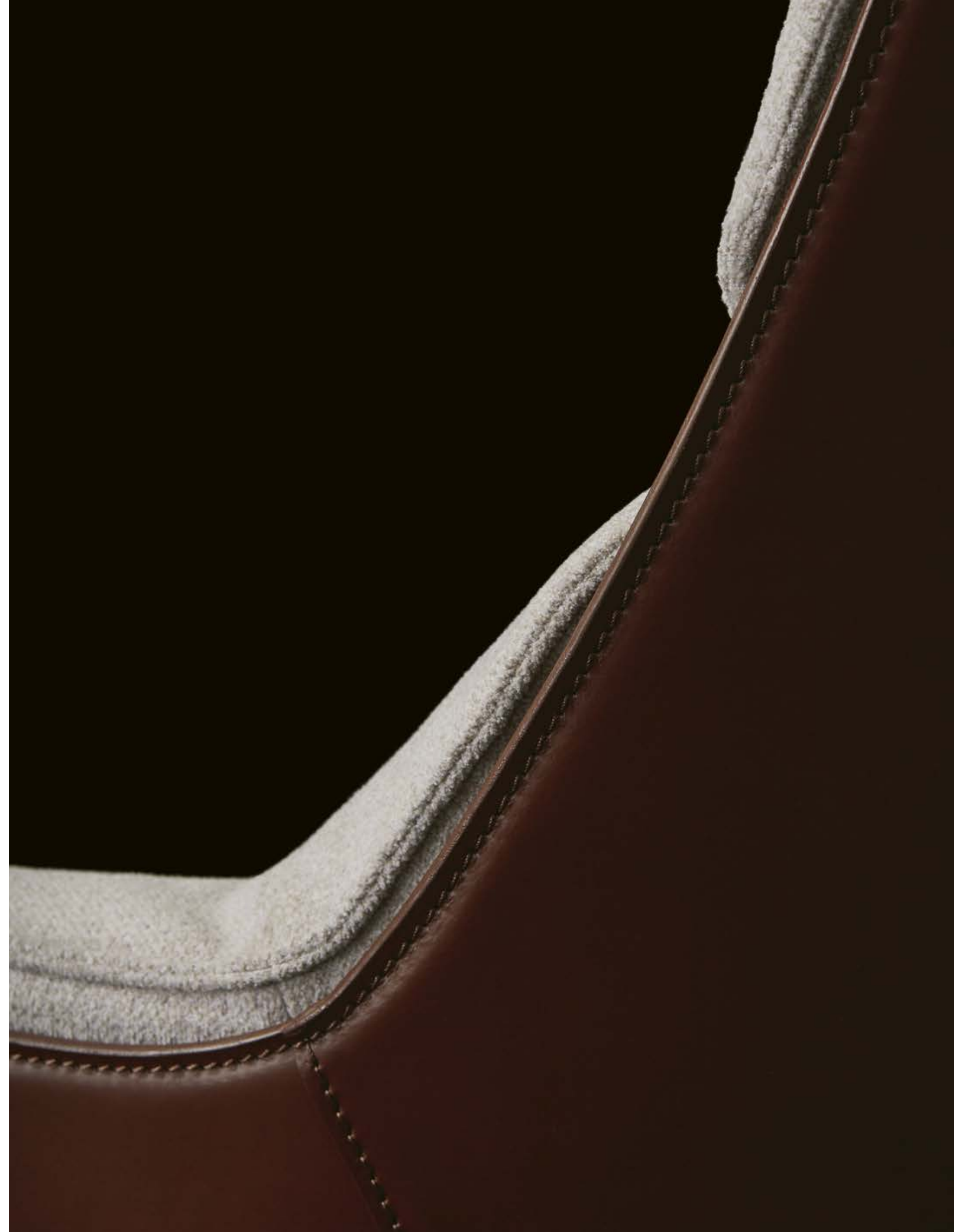



In questa pagina: poltrona Kaori Lounge con scocca esterna e basamento in cuoio 29 tortora, scocca interna e seduta in pelle sfoderabile Silk 02 beige, base girevole e piedini brown nickel opaco. Pouf poggiapiedi con basamento in cuoio 29 tortora, rivestimento in pelle sfoderabile Silk 02 beige, piedini brown nickel opaco. Tavolini Ilda con struttura in fusione d'ottone bronzata e piano in lapislazzulo blu.

This page: Kaori Lounge armchair with outer shell and base in hide 29 tortora, inner shell and seat in removable leather Silk 02 beige, swivel base and mat brown nickel feet. Footstool with base in hide 29 tortora, cover in removable leather Silk 02 beige, mat brown nickel feet. Ilda coffee tables with structure in bronzed brass casting and top in blue lapis lazuli.



Nella pagina precedente: poltrone Kaori Lounge, a sinistra con scocca esterna e basamento in cuoio 07 castagna, scocca interna e seduta in tessuto sfoderabile Agadir 01 sabbia. A destra, con scocca esterna e basamento in cuoio 02 nero, scocca interna e seduta in pelle sfoderabile Silk 08 nero, entrambe con base girevole e piedini brown nickel opaco. In questa pagina e nella successiva: poltrona Kaori Lounge con scocca esterna e basamento in cuoio 02 nero, scocca interna e seduta in pelle sfoderabile Silk 08 nero, base girevole e piedini brown nickel opaco. Pouf poggiapiedi con basamento in cuoio 02 nero, rivestimento in pelle sfoderabile Silk 08 nero, piedini brown nickel opaco.

Previous page: Kaori Lounge armchairs, to the left with outer shell and base in hide 07 castagna, inner shell and seat in removable fabric Agadir 01 sabbia. To the right, with outer shell and base in hide 02 nero, inner shell and seat in removable leather Silk 08 nero, both with swivel base and mat brown nickel feet. This and next page: Kaori Lounge armchair with outer shell and base in hide 02 nero, inner shell and seat in removable leather Silk 08 nero, swivel base and mat brown nickel feet. Footstool with base in hide 02 nero, cover in removable leather Silk 08 nero, mat brown nickel feet.

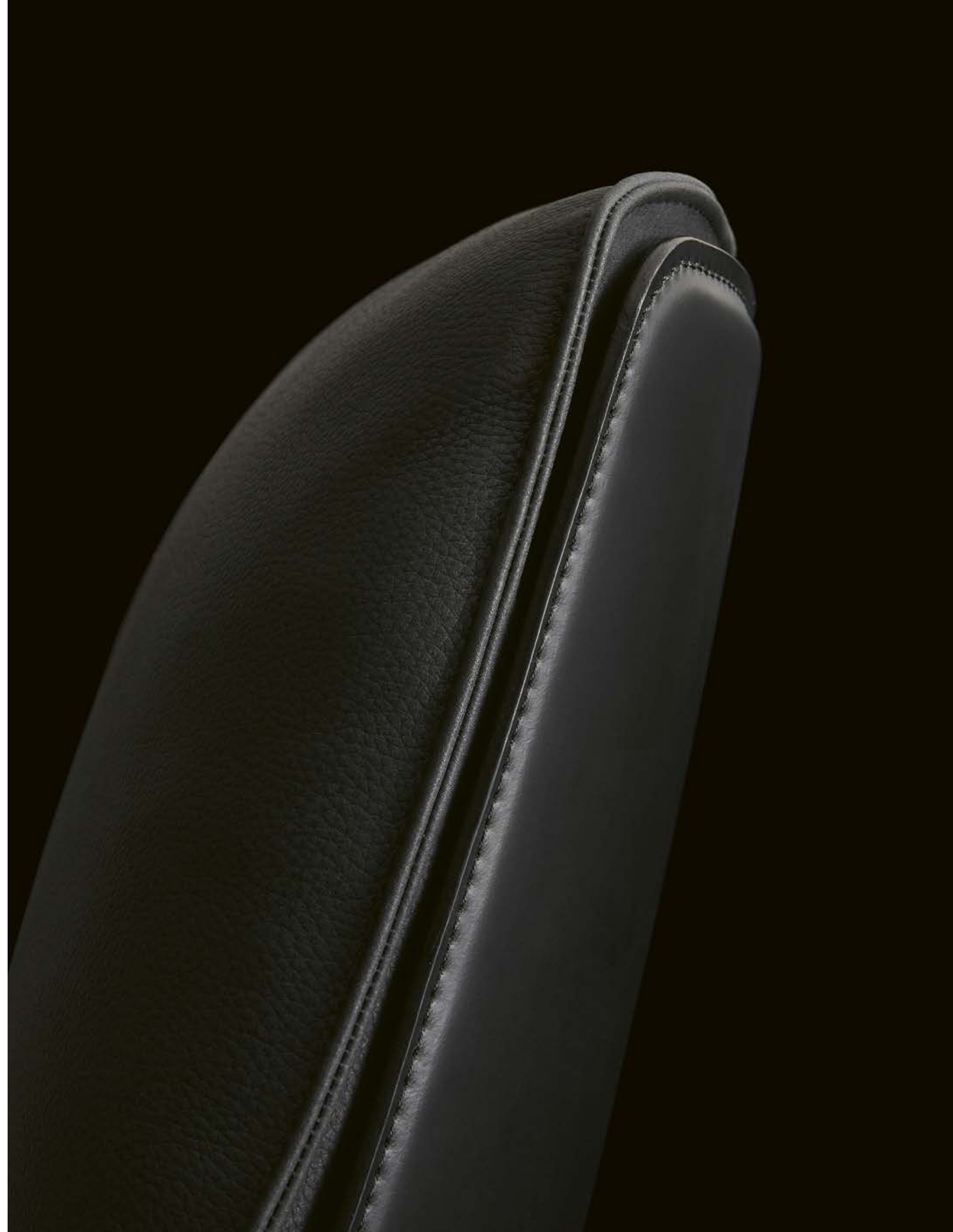



KAORI LOUNGE
Design Jean-Marie Massaud

Poltrona

Scocca in poliuretano compatto con inserto in poliuretano flessibile. Cuscino seduta in poliuretano flessibile a quote differenziate e prriverestimento parti in tela cotone con piuma. Sottosedile in legno e derivati rivestito in cuoio colori. Basamento girevole con ritorno o fisso, in acciaio verniciato brown nickel opaco, piedi in alluminio verniciato brown nickel opaco. Rivestimento non sfoderabile scocca esterna in cuoio colori, rivestimento sfoderabile scocca interna e seduta in tessuto o in pelle Silk e Soft.

Armchair

Compact polyurethane shell with flexible polyurethane insert. Seat cushion in flexible polyurethane with differentiated densities and pre-cover with parts in cotton canvas with down. Underseat structure in wood and wood-derivatives, covered in hide in the sample colours. Swivel base with automatic returning mechanism or fixed base, in mat brown nickel painted steel. Outer shell cover in non-removable hide in the sample colours, inner shell cover and seat cushion in removable fabric or leather Silk and Soft.

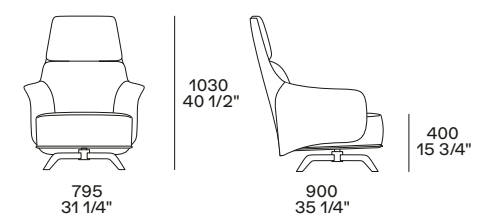

basamento girevole
swivel base

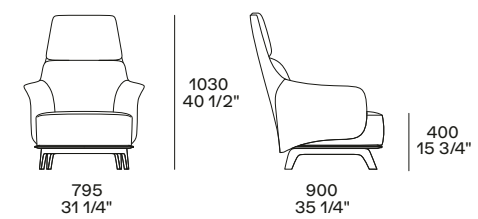

basamento fisso
fixed base

Pouf

Seduta in poliuretano flessibile a quote differenziate e prriverestimento parti in tela cotone con piuma. Sottosedile in legno e derivati rivestito in cuoio colori. Basamento fisso in acciaio verniciato brown nickel opaco, piedi in alluminio verniciato brown nickel opaco. Rivestimento in tessuto o pelle sfoderabile.

Pouf

Seat in flexible polyurethane with differentiated densities and pre-cover with parts in cotton canvas with down. Underseat structure in wood and wood-derivatives covered in hide in the sample colours. Fixed base in mat brown nickel painted steel, feet in mat brown nickel painted aluminium. Removable cover in fabric or leather.



DUKE SIDEBOARD

Duke è una collezione di madie i cui volumi, solidi e imponenti, sono alleggeriti da linee curve che guardano al mondo dell'ebanisteria, e in generale a un mondo di lavorazioni di grande valore artigianale. In diverse altezze e dimensioni, Duke spicca nella zona giorno per la presenza d'impatto, ma anche per i dettagli ricercati come il vassoio da posizionare sul top.

Duke is a sideboard collection whose solid and imposing volumes are lightened by curved lines inspired by the highest expression of cabinetry and craftsmanship. Available in different heights and sizes, Duke stands out in the living room thanks to its impactful presence and refined details, such as the tray to be placed on the countertop.

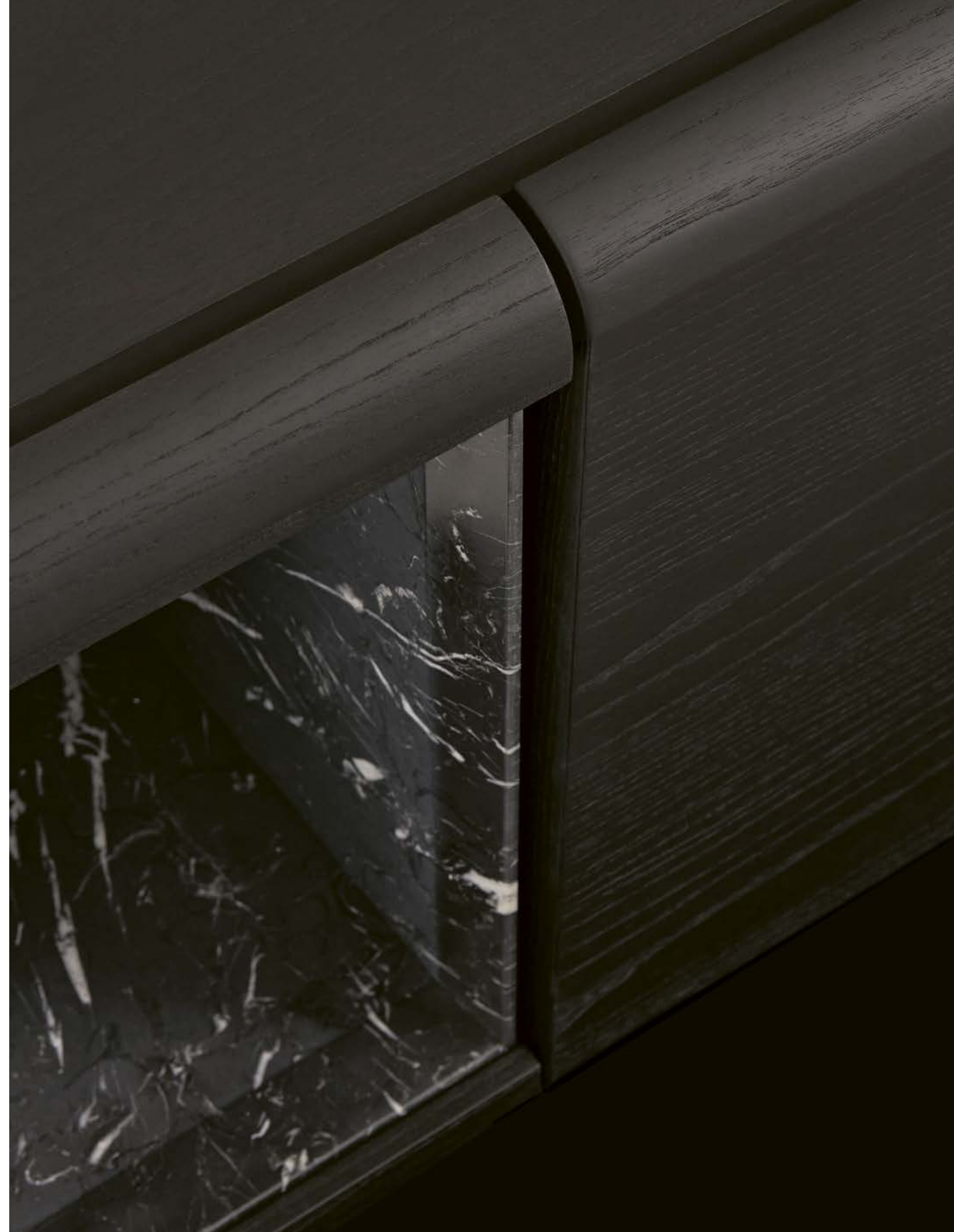







Nelle pagine precedenti: madia Duke in olmo nero con ante battenti e vano a giorno in marmo nero marquina levigato finitura poliester. Struttura interna in rovere bianco, vassoio opzionale in appoggio sul top. In questa pagina: dettaglio della madia Duke in olmo nero con ante a ribalta, top in marmo oyster white levigato. Struttura interna in rovere bianco.

Previous pages: Duke sideboard in black elm with leaf doors and open compartment in mat marble nero marquina polyester finish. Inner structure in white oak, optional tray to be placed on the top. This page: close up of the Duke sideboard in black elm with flap doors, top in mat marble oyster white. Inner structure in white oak.

In questa pagina: madia Duke in olmo nero con ante a ribalta, top in marmo oyster white levigato. Struttura interna in rovere bianco.

This page: Duke sideboard in black elm with flap doors, top in mat marble oyster white. Inner structure in white oak.





In questa pagina: madia Duke laccato lucido liquirizia con ante battenti, struttura interna in rovere bianco. Poltrona Orbis con rivestimento sfoderabile in tessuto Mintaka 02 sabbia e piedini in metallo dark sheer lucido. Tavolino Strata in marmo travertino classico levigato. Tappeto Shindo natural.

This page: Duke sideboard in glossy lacquer liquirizia with leaf doors, inner structure in white oak. Orbis armchair with removable cover in fabric Mintaka 02 sabbia and feet in glossy metal dark sheer. Strata coffee table in mat marble travertino classico. Carpet Shindo natural.

In questa pagina e nella successiva: madia Duke laccato lucido moka con ante battenti. Struttura interna in rovere bianco.

This and next page: Duke sideboard in glossy lacquer moka with leaf doors. Inner structure in white oak.





In questa pagina e nella successiva: madia Duke in olmo nero con cassetti, top in marmo nero marquina levigato finitura poliестere. Struttura interna in rovere bianco.

This and next page: Duke sideboard in black elm with drawers, top in mat marble nero marquina polyester finish. Inner structure in white oak.





DUKE

Design Jean-Marie Massaud

Madie disponibili in diverse configurazioni con ante battenti, ante a ribalta, cassetti e vani a giorno.
 Interno struttura in rovere bianco.
 Frontali, fianchi laterali e retro schienale in olmo nero o laccato lucido colori.
 Top in olmo nero, laccato lucido colori o marmo levigato e lucido (escluso travertino classico, travertino titanium, emperador dark e zecevo).
 Vano a giorno in marmo levigato e lucido (escluso travertino classico, travertino titanium, emperador dark e zecevo).

Sideboards available in different configurations with leaf doors, flap doors, drawers and open compartments.
 Internal structure in white oak.
 Fronts, lateral sides and rear back panel in black elm or glossy lacquered colours.
 Top in black elm, glossy lacquered colours or in mat and glossy marble (except travertino classico, travertino titanium, emperador dark and zecevo).
 Open compartment in mat and glossy marble (except travertino classico, travertino titanium, emperador dark and zecevo).

Madie h 600 Sideboards h 23 1/2"

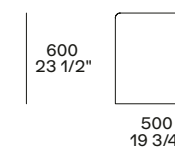
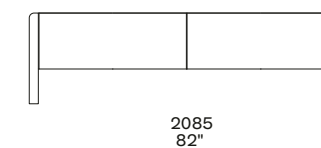
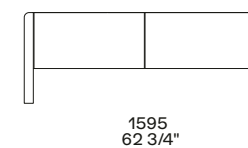

con ante a ribalta
with flap doors

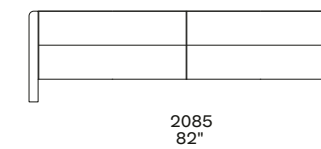
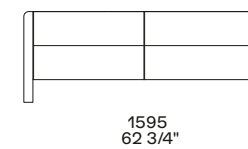

con cassetti
with drawers

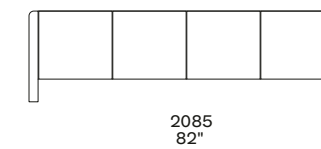
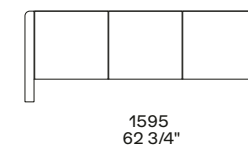

con ante battenti
with leaf doors

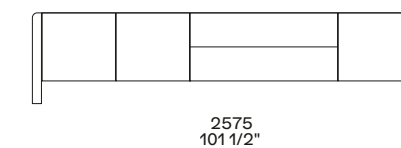
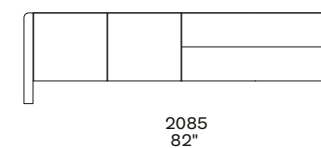

con ante battenti e cassetti
with leaf doors and drawers

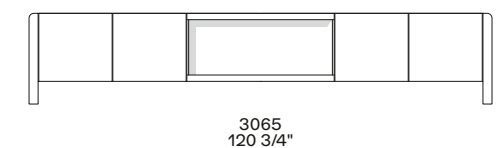
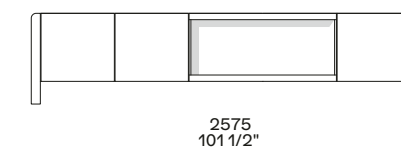
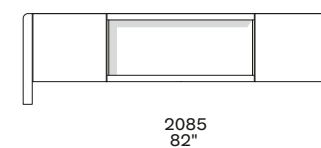

con ante battenti e vano a giorno
with leaf doors and open compartment

Madie h 750
Sideboards h 29 1/2"

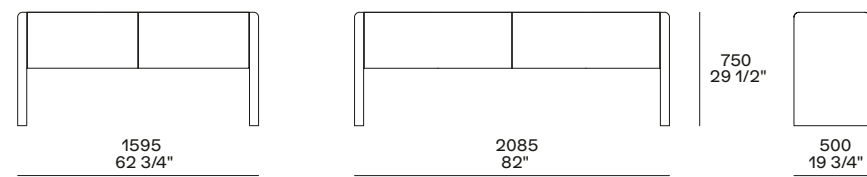

con ante a ribalta
with flap doors

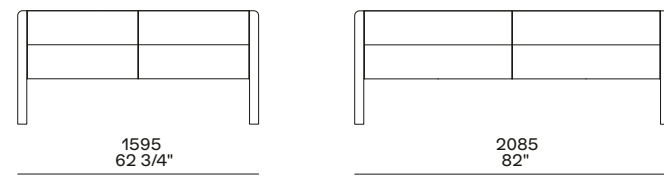

con cassetti
with drawers

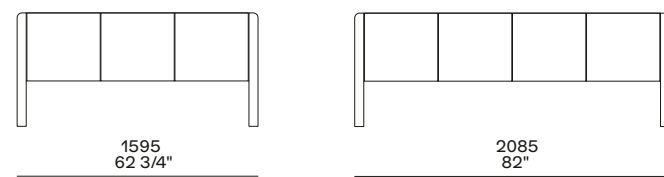

con ante battenti
with leaf doors

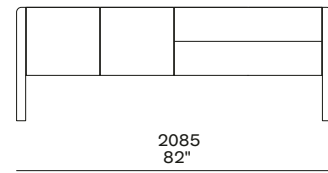

con ante battenti e cassetti
with leaf doors and drawers

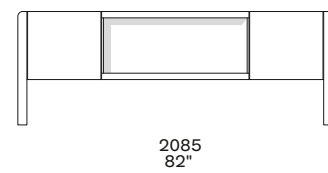

con ante battenti e vano a giorno
with leaf doors and open compartment

Madie h 900
Sideboards h 35 1/2"

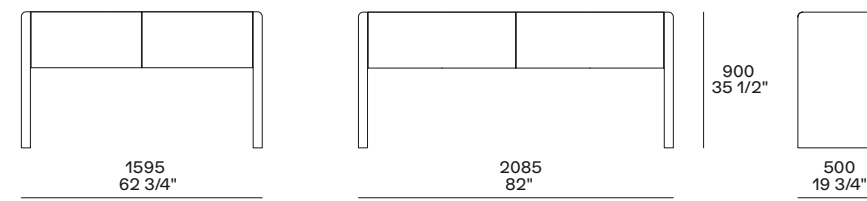

con ante a ribalta
with flap doors

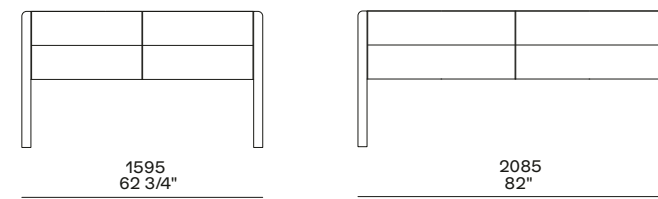

con cassetti
with drawers

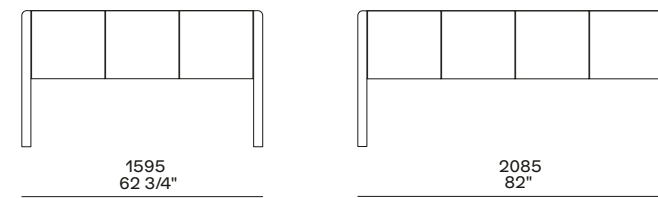

con ante battenti
with leaf doors

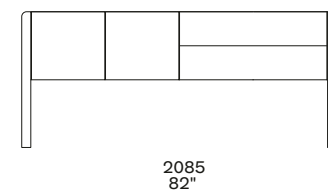

con ante battenti e cassetti
with leaf doors and drawers

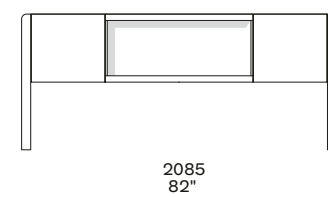

con ante battenti e vano a giorno
with leaf doors and open compartment

AIKO SIDEBOARD



La collezione Aiko si arricchisce di una nuova madia alta con anta a ribalta, una peculiarità tecnica che la rende unica nel suo genere, enfatizzandone l'eleganza. Il meccanismo di ribalta, nascosto, è invisibile nonostante la struttura sia completamente in vetro. Ideale come mobile bar, la madia è caratterizzata da finiture di pregio, cui si aggiunge il top in marmo.

The Aiko collection is enriched with a new high sideboard featuring a flap door, a technical peculiarity that makes it unique, emphasizing its elegance. The hidden flap mechanism is invisible despite the structure being completely made of glass. Ideal as a bar cabinet, the sideboard features high-quality finishes and a marble countertop.

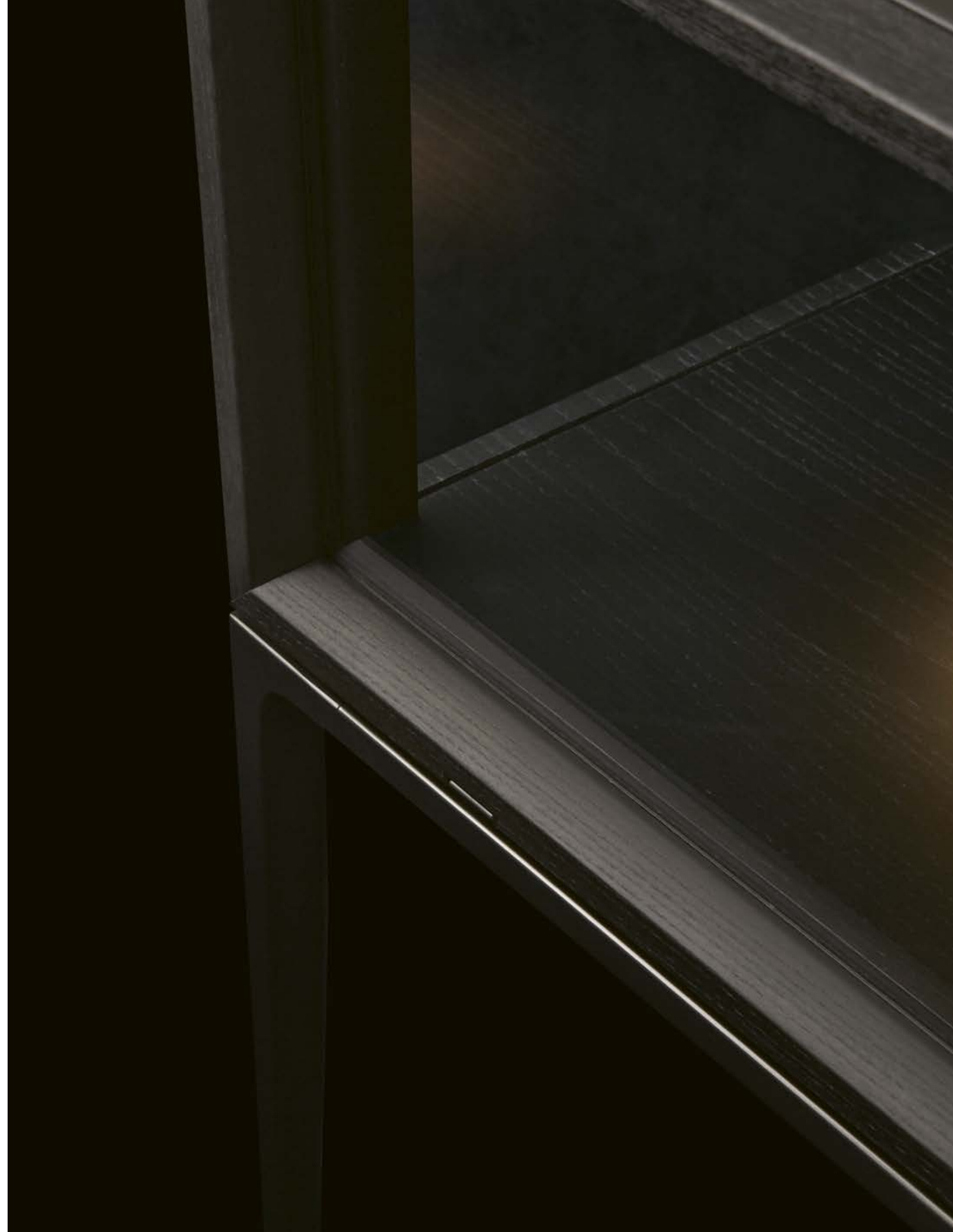



In questa pagina e nella successiva: madia Aiko con struttura e schienali in olmo nero, fianchi e ante a ribalta in vetro trasparente, top in marmo nero marquina levigato finitura poliestere, basamento con piedini brown nickel opaco. Vassoio interno opzionale in olmo nero con fondo in cuoio. Luce a led integrata. Libreria Lexington con montanti a soffitto in ardesia opaco con piedini di regolazione in nickel ardesia. Ripiani in olmo nero e ardesia opaco con luce a led integrata dimmerabile, ripiani in vetro fumé.

This and next page: Aiko sideboard with structure and backs in black elm, sides and flap doors in transparent glass, top in mat marble nero marquina polyester finish, base with feet mat brown nickel. Optional inner tray in black elm with bottom in hide. Integrated led light. Lexington bookcase with floor-ceiling uprights in mat ardesia with levelling feet in nickel ardesia. Shelves in black elm and mat ardesia with dimmable integrated led light, shelves in fumé glass.





AIKO

Design Jean-Marie Massaud

Madia nella nuova configurazione con doppia anta a ribalta.

Struttura in olmo nero. Schienale in olmo nero, vetro trasparente extrachiaro o vetro stratificato con inserto in lino carbone.

Oppure schienale con esterno in olmo nero e interno laccato opaco colori o laccato opaco cuoio colori.

Fianchi laterali e frontali in olmo nero, vetro trasparente extrachiaro o vetro stratificato con inserto in lino carbone.

Maniglie in brown nickel opaco, incassate nel profilo superiore delle ante.

Top in olmo nero o in marmo levigato e lucido (escluso travertino classico, travertino titanium, emperador dark e zecevo).

Basamento con piedini in alluminio verniciato brown nickel opaco.

Vassoio interno opzionale in olmo nero con fondo in cuoio colori. Luce a led integrata.

Sideboard in the new configuration with double flap door.

Structure in black elm. Back in black elm, extralight transparent glass or stratified glass with insert in linen carbone.

Or back panel with external finish in black elm and interior in mat lacquer colours or mat lacquer in hide colours.

Lateral sides and fronts in black elm, extralight transparent glass or stratified glass with insert in linen carbone.

Handles in matt brown nickel, built-in in the upper door profile.

Top in black elm or in mat and glossy marble (except travertino classico, travertino titanium, emperador dark and zecevo).

Base with feet in mat brown nickel painted metal. Optional inner tray in black elm with bottom in hide colours.

Integrated led light.

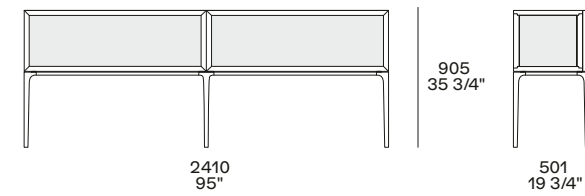

con ante a ribalta
with flap doors

A sinistra e nelle pagine introduttive: madia Aiko con struttura e schienali in olmo nero, fianchi e ante a ribalta in vetro trasparente, top in marmo sahara noir levigato finitura poliester, basamento con piedini brown nickel opaco. Luce a led integrata.

Left and Introduction pages: Aiko sideboard with structure and backs in black elm, sides and flap doors in transparent glass, top in mat marble sahara noir polyester finish, base with feet mat brown nickel. Integrated led light.



ADRIEN TABLE

Adrien di Jean-Marie Massaud è un tavolo dalla presenza carismatica, una nuova icona per gli spazi della convivialità. Il suo profilo classico, quasi archetipico, è reso contemporaneo dalla posizione asimmetrica delle gambe, caratterizzate dall'aspetto scultoreo. Le finiture di pregio ne fanno un'icona versatile.

Adrien by Jean-Marie Massaud is a table with a magnetic presence, a new icon for convivial spaces. Its classic, almost archetypal look is made contemporary by the asymmetrical position of its legs, characterized by their sculpture-like appearance. Its high-quality finishes make it a versatile iconic piece.



In questa pagina e nella successiva: tavolo Adrien con piano in marmo nero marquina levigato finitura poliester, struttura in olmo nero. Sedie Leopold con struttura in olmo nero e rivestimento sfoderabile in pelle Suede 02 corda. Tappeto Trace écru.

This and next page: Adrien table with top in mat marble nero marquina polyester finish, structure in black elm. Leopold chairs with structure in black elm and removable cover in leather Suede 02 corda. Carpet Trace écru.

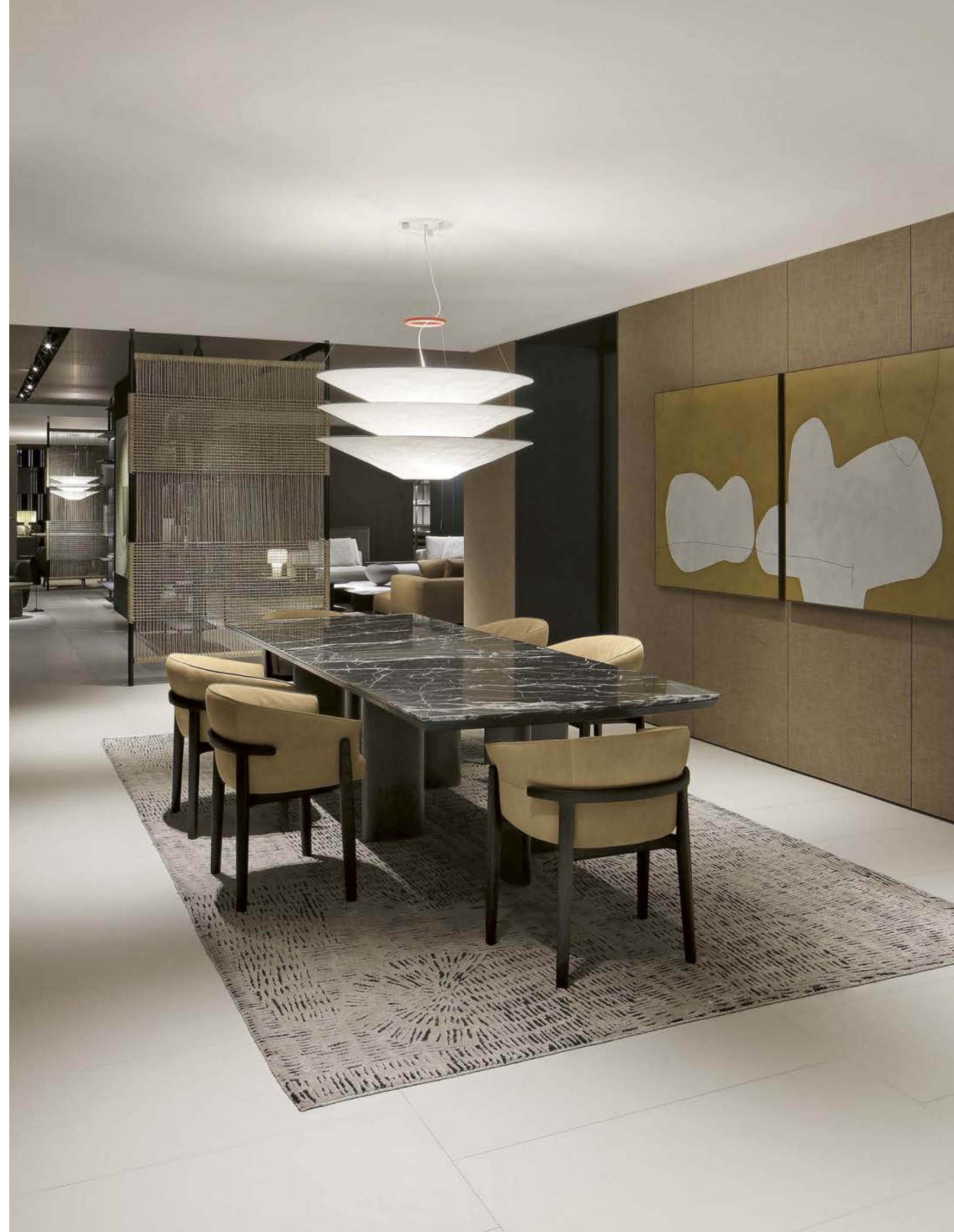







Nella pagina precedente: tavolo Adrien con piano in marmo oyster white levigato, struttura in metallo light sheer opaco. In questa pagina e nella successiva: tavolo Adrien con piano in olmo nero e struttura in olmo nero.

Previous page: Adrien table with top in mat marble oyster white, structure in mat metal light sheer. This and next page: Adrien table with top in black elm and structure in black elm.



In questa pagina e nella successiva: tavolo Adrien con piano e struttura in laccato lucido liquirizia. Pouf New York con rivestimento sfoderabile in velluto Persia 26 nero e piedini in brown nickel lucido. Tappeto Trace écru.

This and next page: Adrien table with top and structure in glossy lacquer liquirizia. New York pouf with removable cover in velvet Persia 26 nero and glossy brown nickel feet. Carpet Trace écru.





In questa pagina: tavolo Adrien con piano in marmo oyster white levigato, struttura in metallo light sheer opaco.

This page: Adrien table with top in mat marble oyster white, structure in mat metal light sheer.





In questa pagina: dettaglio del tavolo Adrien in olmo nero nella versione con piano rotondo.

This page: close up of the Adrien table in black elm in the version with round top.

In questa pagina: tavolo Adrien con piano in olmo nero e struttura in metallo dark sheer opaco.

This page: Adrien table with top in black elm and structure in mat metal dark sheer.



ADRIEN

Design Jean-Marie Massaud

Tavoli con struttura in massello finitura olmo nero, metallo laccato lucido colori o metallo verniciato opaco e lucido light sheer o dark sheer. Piano in olmo nero o marmo levigato e lucido (escluso travertino classico, travertino titanium, emperador dark e zecevo).

Tables with structure in solid wood finishes black elm, glossy lacquered colours metal or mat and glossy light sheer or dark sheer painted metal. Top in black elm or mat and glossy marble (except travertino classico, travertino titanium, emperador dark and zecevo).

Piano legno Wooden top

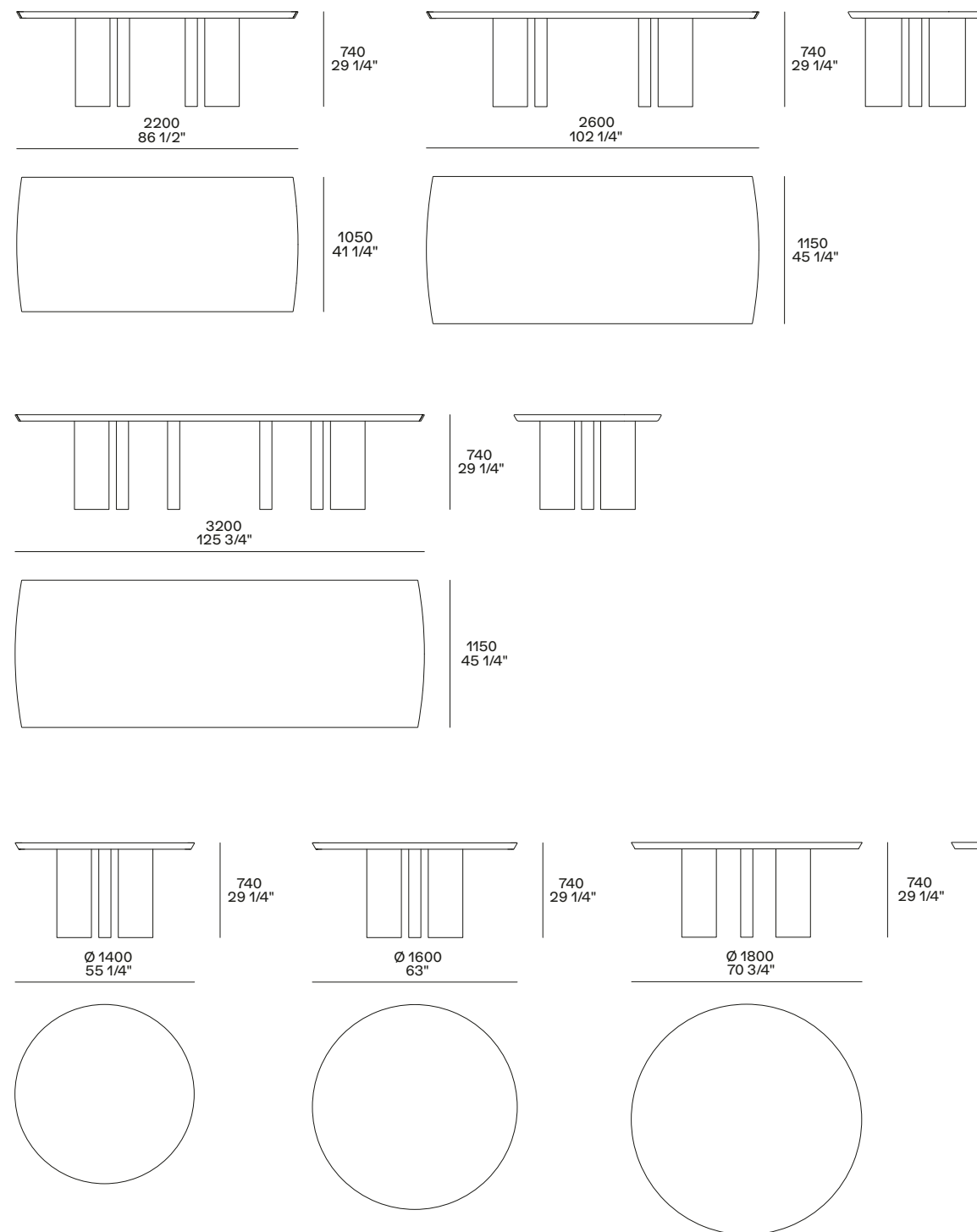

Piano marmo Marble top

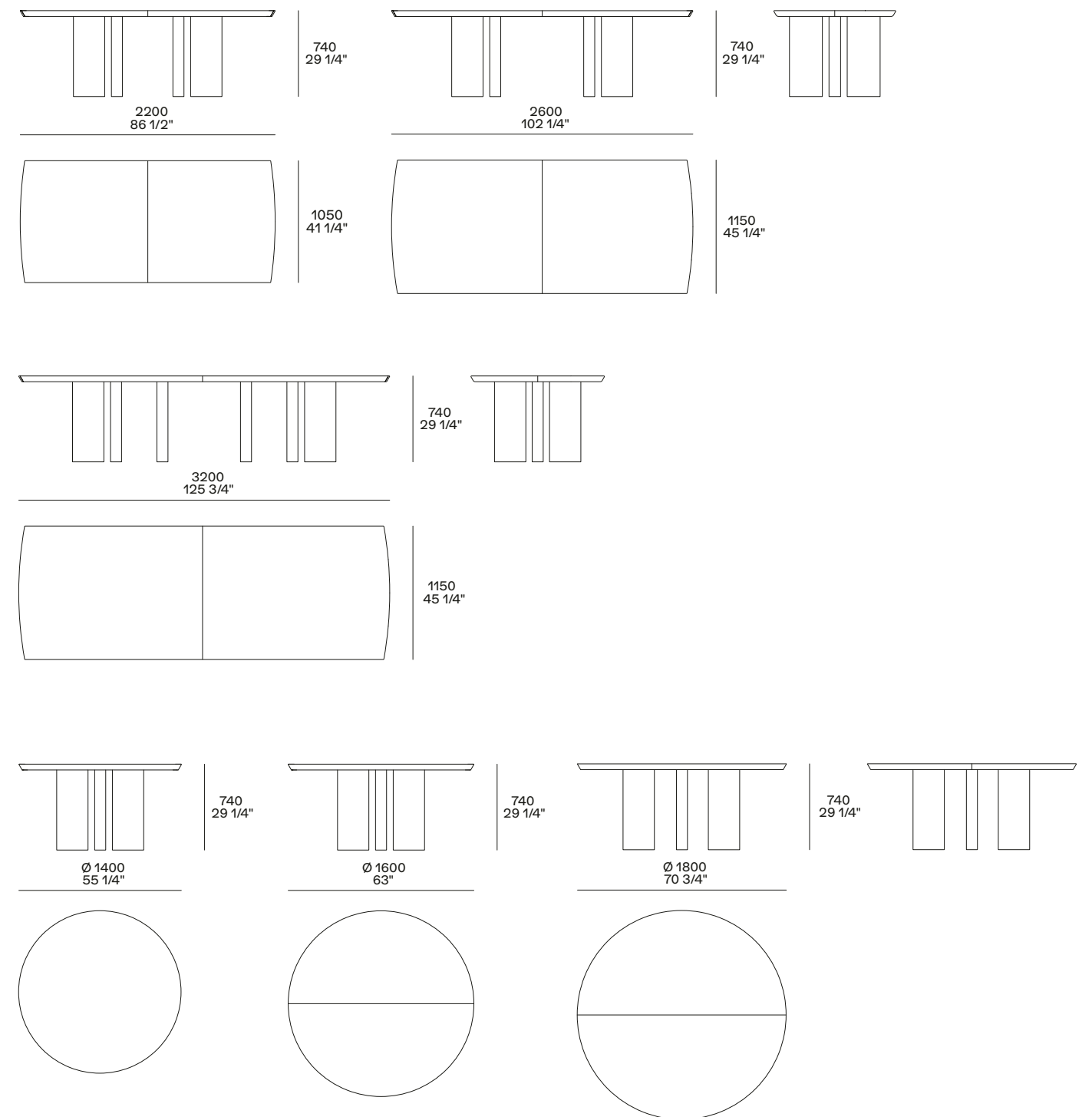



LEOPOLD CHAIR

Jean-Marie Massaud riscrive la filosofia del dining con una sedia confortevole come una poltroncina. Costituita da un cuscino avvolgente racchiuso in un'essenziale struttura in legno, la poltroncina Leopold trasforma il tempo della convivialità in un'esperienza piacevole ed elegante.

Jean-Marie Massaud reimagines the concept of dining by designing a chair as comfortable as an armchair. Consisting of an enveloping cushion enclosed in a minimalist wooden frame, the Leopold small armchair transforms moments of conviviality into delightful and graceful experiences.





In questa pagina e nella successiva: sedie Leopold con struttura in olmo nero e rivestimento sfoderabile in pelle Suede 02 corda. Tavolo Adrien con piano in marmo nero marquina opaco finitura poliester, struttura in olmo nero. Tappeto Trace écreu.

This and next page: Leopold chair with structure in black elm and removable cover in leather Suede 02 corda. Adrien table with top in mat marble nero marquina polyester finish, structure in black elm. Carpet Trace écreu.





Nella pagina precedente: sedie Leopold con struttura in olmo nero, rivestimento sfoderabile in pelle Silk 12 senape e in tessuto Mizar 09 nero. In questa pagina e nella successiva: sedia Leopold con struttura in olmo nero e rivestimento sfoderabile in pelle Suede 02 corda.

Previous page: Leopold chairs with structure in black elm, removable cover in leather Silk 12 senape and fabric Mizar 09 nero. This and next page: Leopold chair with structure in black elm and removable cover in leather Suede 02 corda.





LEOPOLD

Design Jean-Marie Massaud

Sedia con struttura in massello finitura olmo nero o rovere spessart.

Struttura schienale e sedile in metallo con poliuretano ignifugo monoquota.

Cuscino seduta in legno con cinghie elastiche annegato in poliuretano ignifugo più inserto in poliuretano flessibile e viscoelastico.

Schienale in poliuretano flessibile stampato monoquota e inserto in piuma.

Rivestimento sfoderabile in tessuto o pelle.

Chair with structure in solid wood finishes black elm or spessart oak.

Backrest and seat structure in metal with single-density fireproof polyurethane.

Seat cushion in wood with elastic belts embedded in fireproof polyurethane and viscoelastic foam.

Backrest in single-density flexible moulded polyurethane and insert in down.

Removable cover in fabric or leather.

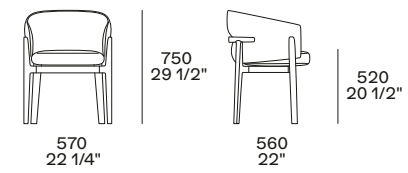



IPANEMA CHAIR

La collezione Ipanema di Jean-Marie Massaud si arricchisce di una nuova variante della sedia. Senza imbottitura, sostituita da un sottile rivestimento in cuoio lavorato artigianalmente e curvato all'altezza dello schienale per un maggiore comfort, la sedia acquista un design più dinamico e ricercato.

Jean-Marie Massaud's Ipanema collection is enhanced with the addition of this new chair variant. The padding is replaced by thin, handcrafted hide upholstery, curved over the backrest area, for greater comfort, giving the chair a more dynamic and sophisticated feel.



In questa pagina e nella successiva: sedia Ipanema con braccioli, rivestimento non sfoderabile in cuoio 29 tortora e struttura in olmo nero. Tavolo Monolith con piano in marmo sahara noir levigato finitura poliestere e tavolino Dama in laccato lucido muschio.

This and next page: Ipanema chair with armrests, cover in non-removable hide 29 tortora and structure in black elm. Monolith table with top in mat marble sahara noir polyester finish and glossy lacquered muschio Dama coffee table.





Nella pagina successiva: sedie Ipanema con braccioli, rivestimento non sfoderabile in cuoio 02 nero e 08 fango, struttura in olmo nero.

Next page: Ipanema chairs with armrests, cover in non-removable hide 02 nero and 08 fango, structure in black elm.



In questa pagina e nella successiva: sedia Ipanema senza braccioli, rivestimento non sfoderabile in cuoio 07 castagna, struttura in olmo nero.

This and next page: Ipanema chair without armrests, cover in non-removable hide 07 castagna, structure in black elm.





IPANEMA

Design Jean-Marie Massaud

Sedia con struttura in legno massello
finitura olmo nero o rovere spessart.
Seduta e schienale in cuoio colori non
sfoderabile.

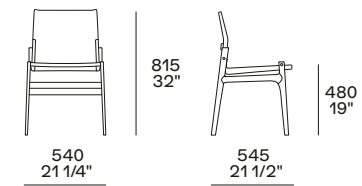

Chair with structure in solid wood finishes
black elm or spessart oak.
Seat and backrest in non-removable hide
in the sample colours.

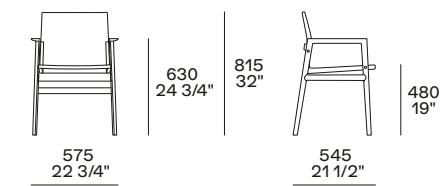



CURVE STOOL

La collezione Curve di Emmanuel Gallina si arricchisce dello sgabello nelle due versioni alta e bassa, portando nell'ambiente cucina l'eleganza della sedia. Anche nello sgabello il legno è protagonista, con una lavorazione che si fa particolarmente accurata nello schienale dalla curvatura accentuata.

Emmanuel Gallina's Curve collection is enriched with the addition of both the high and low stool, bringing the elegance of the chair into the kitchen environment. Wood is again the focal material here, with workmanship being particularly accurate in the backrest featuring a pronounced curvature.



In questa pagina e nella successiva: sgabelli Curve con rivestimento non sfoderabile in pelle Suede 02 corda, struttura in olmo nero e poggiapiedi in acciaio inox.

This and next page: Curve stools with non-removable cover in leather Suede 02 corda, structure in black elm and footrest in stainless steel.





CURVE

Design Emmanuel Gallina

Sgabello con struttura in massello finitura olmo nero o rovere spessart. Seduta in legno e derivati con inserto in poliuretano flessibile. Schienale in poliuretano compatto con inserto in poliuretano flessibile. Rivestimento non sfoderabile in tessuto o pelle. Poggiapiedi in legno con inserto in acciaio inox.

Stool with structure in solid wood finishes black elm or spessart oak. Seat in wood and wood-derivatives with flexible polyurethane insert. Backrest in compact polyurethane with flexible polyurethane insert. Non-removable cover in fabric or leather. Footrest in wood with insert in stainless steel.

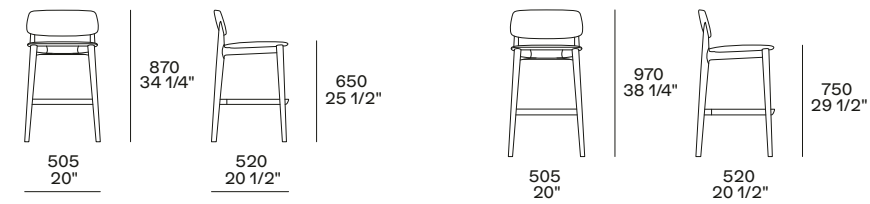

A sinistra: sgabelli Curve, nelle due versioni alta e bassa, rivestimento non sfoderabile in pelle Silk 02 beige e in tessuto Altair 06 senape, entrambi con struttura in olmo nero e poggiapiedi in acciaio inox.

Left: Curve stools, in the two versions high and low, non-removable cover in leather Silk 02 beige and in fabric Altair 06 senape, both with structure in black elm and footrest in stainless steel.

BRERA NIGHT COLLECTION

Nella collezione Brera l'eleganza si esprime attraverso un segno orizzontale, pulito e contemporaneo. È così anche per il letto e i comodini, con cui Jean-Marie Massaud porta l'idea di un paesaggio domestico dalla forte connotazione architettonica nella zona notte. Nel letto, la base in cuoio richiama i dettagli couture del divano, così come l'ampia testiera.

In the Brera collection, elegance is expressed through a horizontal, clean and contemporary design. This is also the case for the bed and night tables, allowing Jean-Marie Massaud to apply the idea of a domestic landscape with strong architectural connotations to the bedrooms. The base in hide of the bed is reminiscent of the couture details of the sofa, as is the wide headboard.

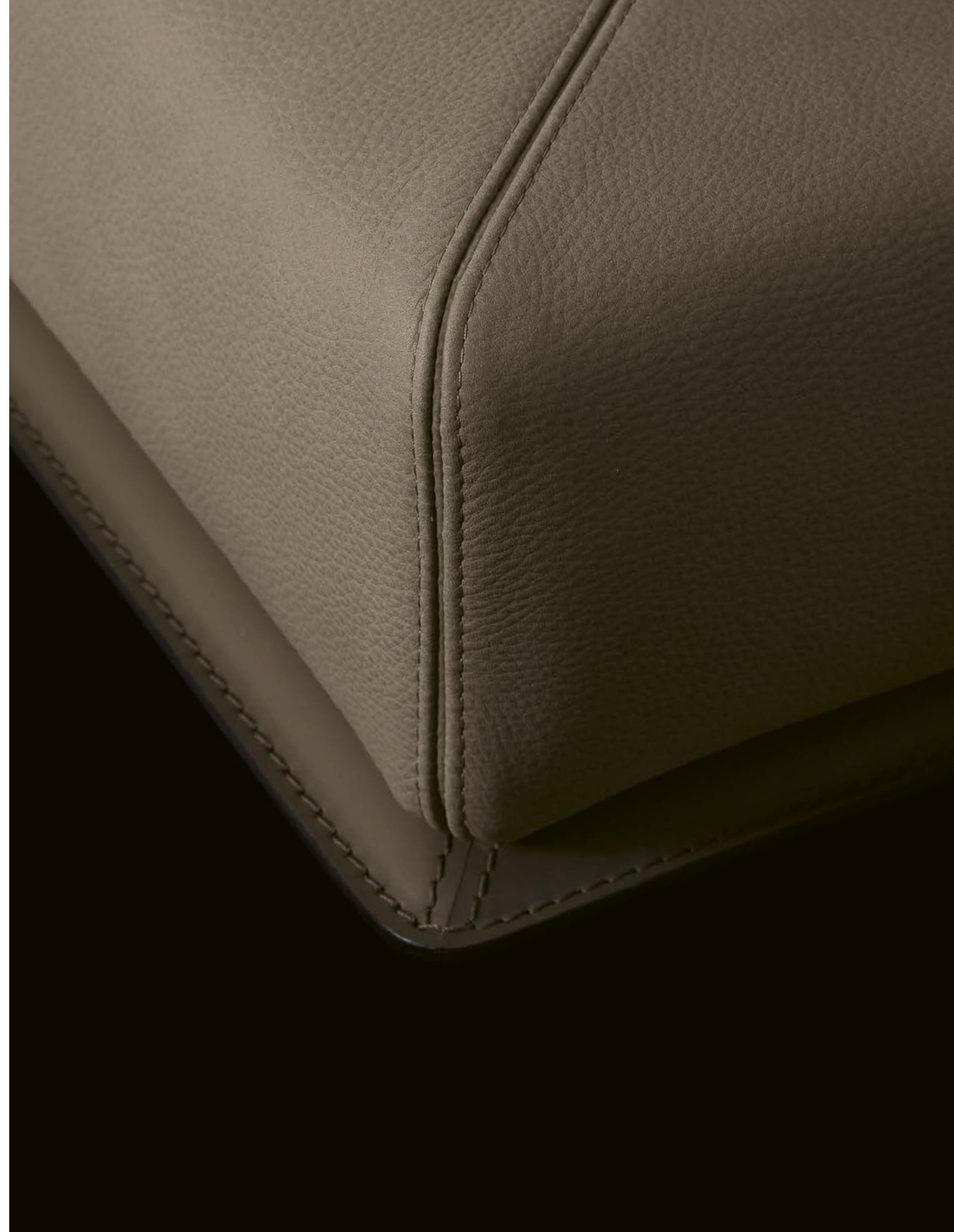

In questa pagina e nelle successive: letto Brera con rivestimento sfoderabile in tessuto Mizar 04 fango e basamento in cuoio 29 tortora. Rulli in pelle sfoderabile Silk 02 beige. Biancheria da letto coordinata in cotone Provence 01 bianco e 08 polvere con profili polvere. Coperta Linus notte. Comodino Brera in olmo nero con cassetto.

This and next pages: Brera bed with removable cover in fabric Mizar 04 fango and base in hide 29 tortora. Roll cushions in removable leather Silk 02 beige. Coordinated bed linen in cotton Provence 01 bianco and 08 polvere with profiles in polvere. Blanket Linus notte. Brera night table in black elm with drawer.









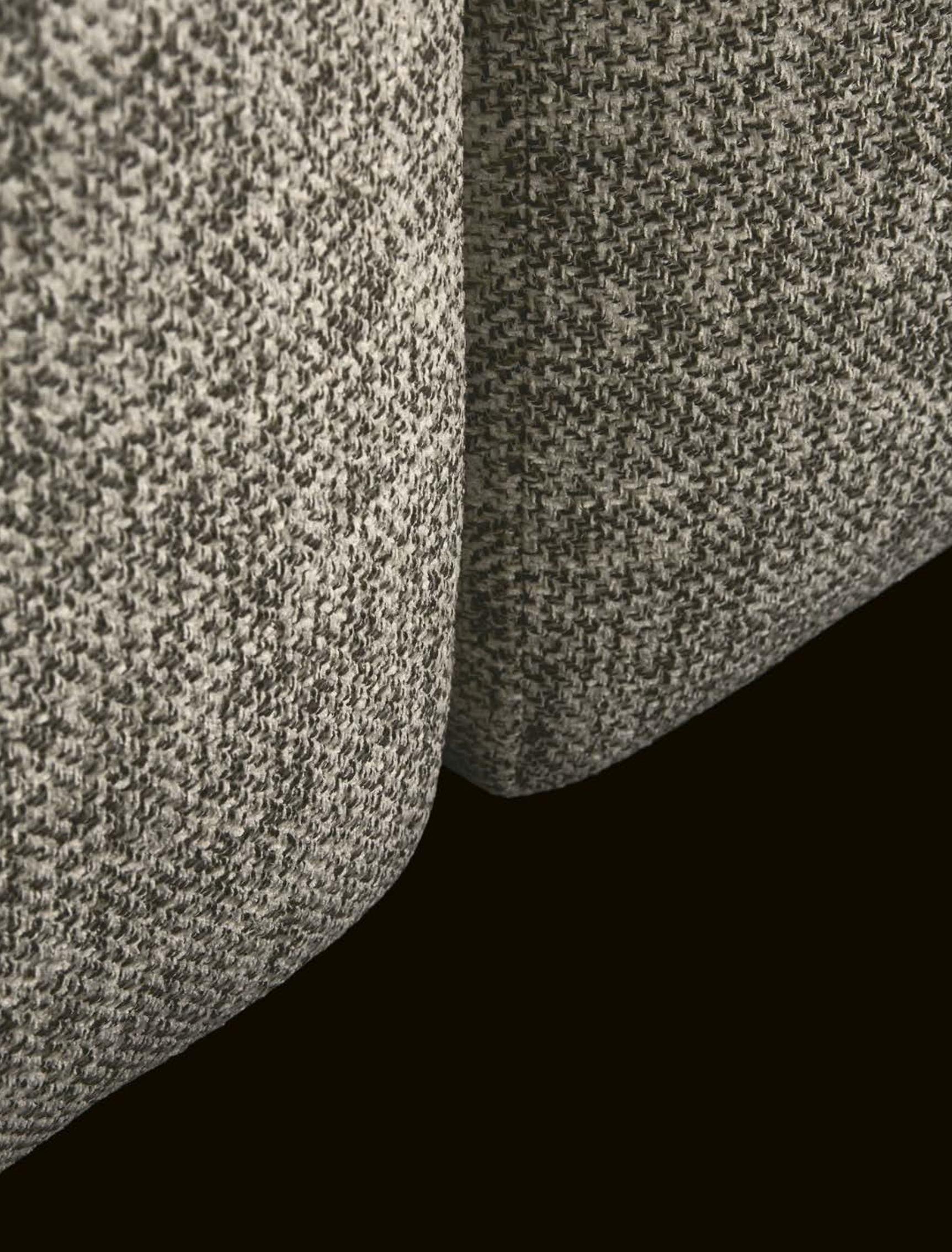

Nella pagina precedente: letto Brera con rivestimento sfoderabile in pelle Silk 02 beige e basamento in cuoio 08 fango. Rulli in tessuto sfoderabile Brest 12 sabbia. Biancheria da letto coordinata in cotone Provence 02 panna e 08 polvere. Coperta Linus corda. In questa pagina e nella successiva: letto Brera con rivestimento sfoderabile in tessuto Mizar 04 fango e basamento in cuoio 08 fango. Rulli in pelle sfoderabile Nabuk 08 prussia. Biancheria da letto coordinata in cotone Provence 01 bianco e 03 ghiaccio con profilo bianco. Coperta Linus notte.

Previous page: Brera bed with removable cover in leather Silk 02 beige and base in hide 08 fango. Roll cushions in removable fabric Brest 12 sabbia. Coordinated bed linen in cotton Provence 02 panna and 08 polvere. Blanket Linus corda. This and next page: Brera bed with removable cover in fabric Mizar 04 fango and base in hide 08 fango. Roll cushions in removable leather Nabuk 08 prussia. Coordinated bed linen in cotton Provence 01 bianco and 03 ghiaccio with profile in bianco. Blanket Linus notte.



In questa pagina e nella successiva: letto Brera con rivestimento sfoderabile in tessuto Naxos 18 canapa e basamento in cuoio 26 invecchiato. Rulli in pelle sfoderabile Nabuk 01 latte. Biancheria da letto coordinata in cotone Provence 01 bianco e 08 polvere. Coperta Linus latte. Comodino Brera in olmo nero con cassetto.

This and next page: Brera bed with removable cover in fabric Naxos 18 canapa and base in hide 26 invecchiato. Roll cushions in removable leather Nabuk 01 latte. Coordinated bed linen in cotton Provence 01 bianco and 08 polvere. Blanket Linus latte. Brera night table in black elm with drawer.







In questa pagina: dettaglio del comodino Brera in olmo nero con cassetto. Nella pagina successiva: da sinistra, comodino Brera in olmo nero con cassetto, top in marmo nero marquina levigato; comodino Brera in olmo nero; comodino Brera in olmo nero con cassetto.

This page: close up of Brera night table in black elm with drawer. Next page: from the left, Brera night table in black elm with drawer, top in mat marble nero marquina; Brera night table in black elm; Brera night table in black elm with drawer.



BRERA

Design Jean-Marie Massaud

Letto

Testata in legno e derivati con imbottitura in poliuretano flessibile a quote differenziate con priverivestimento in fibra di poliestere e rivestimento in tessuto o pelle sfoderabile. Base letto in legno massello con imbottitura in poliuretano flessibile monoquota, priverivestimento in fibra di poliestere, rivestimento in tessuto e pelle sfoderabile o in cuoio colori non sfoderabile. Cornice perimetrale in cuoio colori non sfoderabile, piedini in materiale plastico. Interruttore luce, presa elettrica, presa USB e USB-2 opzionali, integrati nella testata, esclusa versione l 2570.

Predisposto per materassi:

l 1800-2000 x p 2000

King size

letto l 2150 x p 2410

materasso l 1930 x p 2030

Tipologia di rete:

- rete fissa
- sommier

Bed

Headboard in wood and wood-derivatives with padding in multi-density flexible polyurethane, pre-cover in polyester fibre and cover in removable fabric or leather. Bed frame in solid wood with padding in single-density flexible polyurethane, pre-cover in polyester fibre, final cover in removable fabric and leather or in non-removable hide in the sample colours. Perimeter frame in non-removable hide in the sample colours, feet in plastic material. Light switch, electrical socket, USB socket and USB-2 optional, integrated in the headboard, except version w 101 1/4".

For mattresses:

w 70 3/4"-78 3/4" x d 78 3/4"

King size

bed w 84 3/4" x d 95"

mattress w 76" x d 80"

Bedstead type:

- fixed bedstead
- sommier

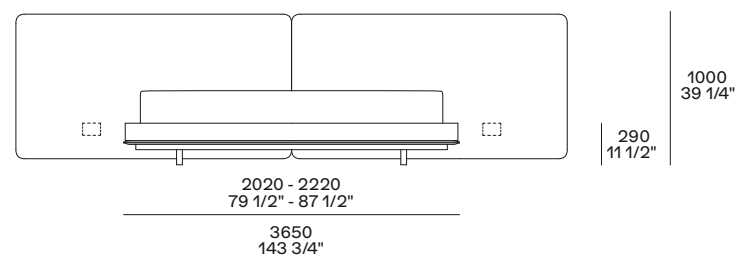
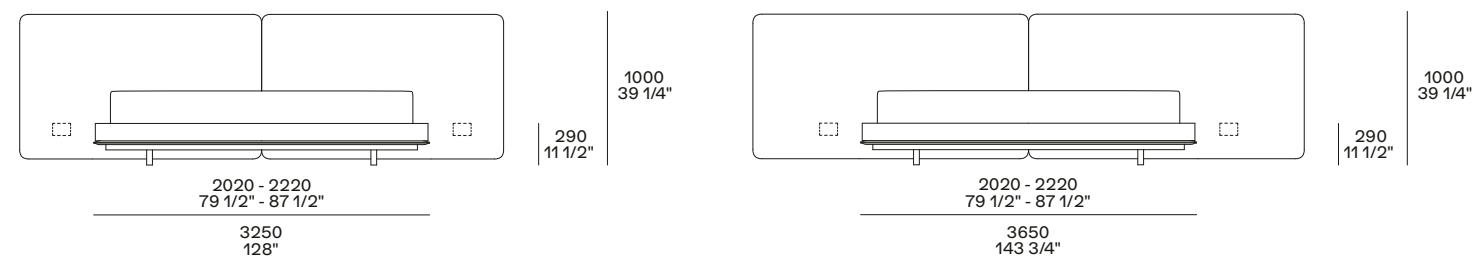
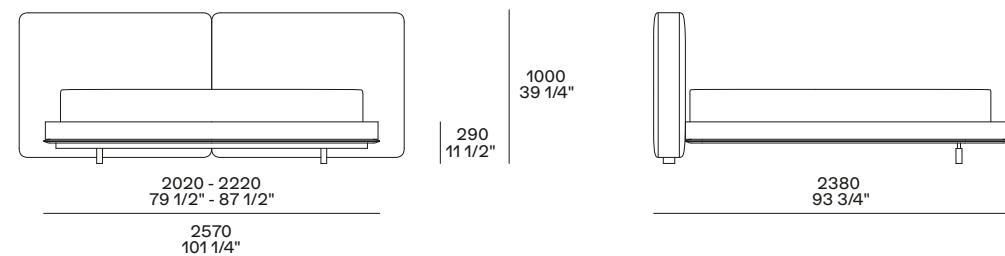

Comodini

Struttura e frontali in rovere spessart o olmo nero. Top in rovere spessart, olmo nero o in marmo levigato e lucido (escluso travertino classico, travertino titanium, emperador dark e zecevo).

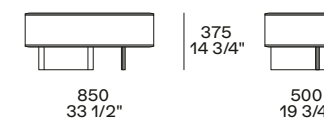
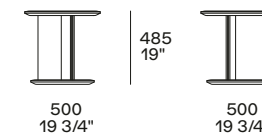

destra - un cassetto
right - one drawer

Night tables

Structure and fronts in spessart oak or black elm. Top in spessart oak, black elm or mat and glossy marble (except travertino classico, travertino titanium, emperador dark and zecevo).

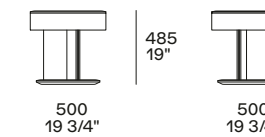

un cassetto
one drawer

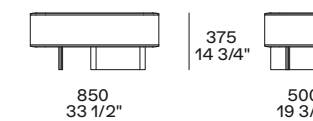

sinistra - un cassetto
left - one drawer



KETCH OUTDOOR SUNBED

A completare la collezione Ketch, disegnata da Jean-Marie Massaud e ispirata al mondo della nautica, è il lettino outdoor. Come divani e poltrone, anche il lettino è caratterizzato da una struttura in iroko solida ed essenziale, che sostiene la morbida cuscinatura. Lo schienale reclinabile, reso ancora più confortevole dal cuscino poggiatesta, nasconde un vano funzionale dove riporre teli e accessori.

Completing the Ketch collection, designed by Jean-Marie Massaud and inspired by the nautical world, is the sunbed. Like the sofas and armchairs, the sunbed features a solid and essential iroko frame that supports the soft cushioning. The reclining backrest, made even more comfortable by the headrest cushion, conceals a functional compartment for storing towels and accessories.







Nelle pagine precedenti: sunbed Ketch con struttura in massello di iroko tinto nero e parti metalliche brown nickel opaco. Rivestimento sfoderabile in tessuto Ghibli 04 sabbia. Cuscino poggiatesta in tessuto Ghibli 04 sabbia. In questa pagina: sunbed Ketch con struttura in massello di iroko naturale e parti metalliche brown nickel opaco. Rivestimento sfoderabile in tessuto Shamal 702 notte. Cuscino poggiatesta in tessuto Shamal 702 notte. Tavolino Strata in Cementoskin® tortora.

Previous pages: Ketch sunbed with structure in solid black-stained iroko and mat brown nickel metal parts. Removable cover in fabric Ghibli 04 sabbia. Headrest cushion in fabric Ghibli 04 sabbia. This page: Ketch sunbed with structure in solid natural iroko and mat brown nickel metal parts. Removable cover in fabric Shamal 702 notte. Headrest cushion in fabric Shamal 702 notte. Strata coffee table in Cementoskin® tortora.

Nella pagina successiva: sunbed Ketch con struttura in massello di iroko naturale e parti metalliche brown nickel opaco. Rivestimento sfoderabile in tessuto Shamal 702 notte. Cuscino poggiatesta in tessuto Shamal 702 notte. In questa pagina: dettaglio dello schienale reclinabile con maniglia in EVA testa di moro.

Next page: Ketch sunbed with structure in solid natural iroko and mat brown nickel metal parts. Removable cover in fabric Shamal 702 notte. Headrest cushion in fabric Shamal 702 notte. This page: close up of the reclining backrest with handle in EVA testa di moro.





KETCH

Design Jean-Marie Massaud

Sunbed con struttura in massello di iroko naturale o iroko tinto nero.
Cuscino seduta e schienale in poliuretano espanso a quote differenziate, cuscino poggiatesta in poliuretano espanso, prerinvolgimento in resinato accoppiato a tela idrorepellente.
Rivestimento sfoderabile in tessuto.
Parti metalliche in alluminio e acciaio inox verniciati brown nickel opaco.
Vano sotto schienale attrezzato con portaoggetti rivestito in materiale tecnico.

Sunbed with structure in solid natural iroko or solid black stained iroko.
Seat cushion and back in multi-density polyurethane foam, headrest cushion in polyurethane foam, resin-coated pre-cover with water-repellent canvas.
Removable cover in fabric.
Metal parts in mat brown nickel painted aluminium and stainless steel.
Storage under the backrest equipped with glove compartment covered in technical material.

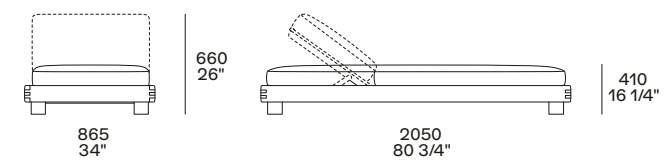

CODE DAY SYSTEM

Code è un sistema trasversale composto di contenitori sospesi, mensole e madie, concepito per il living ma facilmente integrabile nella zona notte. L'elemento nuovo è il portale TV, creato abbinando i moduli Code a un pannello centrale a muro, da personalizzare nelle finiture di Code o in tessuto, in continuità con la boiserie.

Code is a versatile system composed of storage units, shelves and sideboards, designed for the living room but which can also be easily integrated into the bedrooms. The new element is the TV-portal, created by combining Code modules with a central wall panel, to be customized in Code finishes or in fabric, matching the boiserie.





In questa pagina e nelle precedenti: composizione sospesa Code, contenitori a giorno con struttura e ripiani in laccato opaco bronzo, schienali in tessuto Mesh bronzo, luce a led integrata. Contenitori con ante a listelli Tape in olmo nero e vetro trasparente, telaio e maniglia in ardesia opaco, struttura interna in olmo nero, schienali in tessuto Mesh bronzo e cassettiere in olmo nero con top in marmo sahara noir levigato, ripiani in vetro trasparente, luce a led integrata. Portale TV in olmo nero con fianchi in laccato metallico bronzo. Top retroilluminato e fianchi in laccato metallico bronzo. Nelle pagine successive: composizione sospesa Code, contenitori a giorno con struttura e ripiani in laccato metallico bronzo, schienali in olmo nero, luce a led integrata. Contenitori con ante a listelli Tape in olmo nero e vetro trasparente, telaio e maniglia in ardesia opaco, struttura interna in olmo nero, schienali in tessuto Mesh peltro e cassettiere in laccato metallico bronzo con top in marmo sahara noir levigato, ripiani in vetro trasparente, luce a led integrata. Top retroilluminato e fianchi in olmo nero.

This and previous pages: wall mounted Code composition, open storage units with structure and shelves in mat lacquer bronzo, backs in fabric Mesh bronzo, integrated led light. Storage units with Tape slatted doors in black elm and transparent glass, mat ardesia frame and handle, inner structure in black elm, backs in fabric Mesh bronzo and chests of drawers in black elm with top in mat sahara noir marble, transparent glass shelves, integrated led light. TV portal in black elm with sides in metallic lacquer bronzo. Backlit top and sides in metallic lacquer bronzo. Next pages: wall mounted Code composition, open storage units with structure and shelves in metallic lacquer bronzo, backs in black elm, integrated led light. Storage units with Tape slatted doors in black elm and transparent glass, mat ardesia frame and handle, inner structure in black elm, backs in fabric Mesh peltro and chests of drawers in metallic lacquer bronzo with top in mat sahara noir marble, transparent glass shelves, integrated led light. Backlit top and sides in black elm.







CODE

Design R&D Poliform

Contenitori Living a giorno

Struttura e ripiani: laccato opaco bronzo.
Schienali: tessuto Mesh bronzo.
Luce a led integrata.

Contenitori Living con ante Tape

Struttura: olmo nero.
Schienali: tessuto Mesh bronzo.
Ripiani: vetro trasparente.
Cassettiere: olmo nero, top marmo sahara noir levigato. Luce a led integrata.
Ante a listelli Tape: olmo nero e vetro trasparente, telaio e maniglia ardesia opaco.

Portale TV

Piano inferiore, schienale e piano superiore retroilluminato: olmo nero, piani spessore 50.
Disponibile in due dimensioni: l 1800, 2200.

Fianchi laterali: laccato metallico bronzo.
Top retroilluminato: laccato metallico bronzo.

Open storage units Living

Structure and shelves: mat lacquer bronzo.
Backs: fabric Mesh bronzo.
Integrated led light.

Storage units Living with Tape doors

Structure: black elm.
Backs: fabric Mesh bronzo.
Shelves: transparent glass.
Chests of drawers: black elm, mat sahara noir marble top. Integrated led light.
Tape slatted doors: black elm and transparent glass, mat ardesia frame and handle.

TV portal

Lower shelf, back and upper backlit shelf: black elm, shelves thickness 2".
Available in two dimensions: w 70 3/4", 86 1/2".

Lateral sides: metallic lacquer bronzo.
Backlit top: metallic lacquer bronzo.

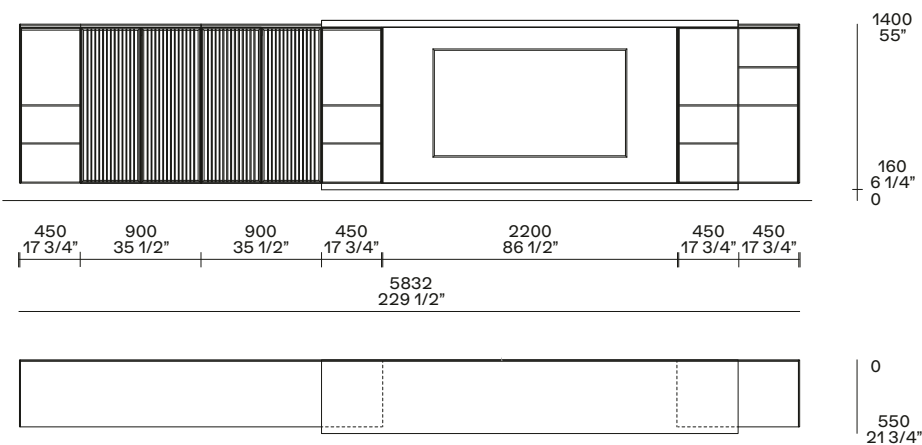

CODE

Design R&D Poliform

Contenitori Living a giorno

Struttura e ripiani: laccato metallico bronzo.
Schienali: olmo nero.
Luce a led integrata.

Contenitori Living con ante Tape

Struttura: olmo nero.
Schienali: tessuto Mesh peltro.
Ripiani: vetro trasparente.
Cassettiere: laccato metallico bronzo, top marmo sahara noir levigato.
Luce a led integrata.
Ante a listelli Tape: olmo nero e vetro trasparente, telaio e maniglia ardesia opaco.

Fianchi laterali: olmo nero.
Top retroilluminato: olmo nero.

Open storage units Living

Structure and shelves: metallic lacquer bronzo.
Backs: black elm.
Integrated led light.

Storage units Living with Tape doors

Structure: black elm.
Backs: fabric Mesh peltro.
Shelves: transparent glass.
Chests of drawers: metallic lacquer bronzo, mat sahara noir marble top. Integrated led light.
Tape slatted doors: black elm and transparent glass, mat ardesia frame and handle.

Lateral sides: black elm.
Backlit top: black elm.

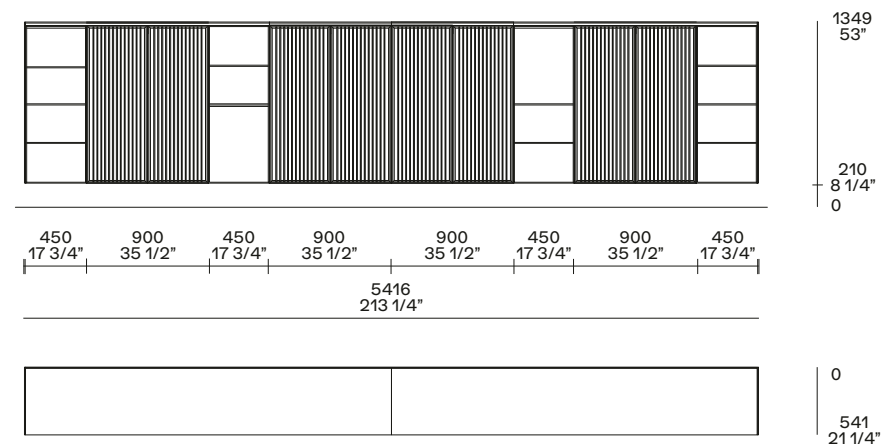

WALL SYSTEM

Wall System è un sistema giorno eccezionalmente versatile, un programma d'arredo in costante evoluzione. Per rispondere alle esigenze dell'interior design contemporaneo, Wall System si arricchisce di nuovi elementi. Quanto alle finiture, la novità più rilevante è la possibilità di rivestire gli schienali e il retro degli elementi in tessuto, creando continuità visiva con la boiserie, in una perfetta integrazione tra Wall System e il sistema Architectural.

Wall System is an exceptionally versatile day system, a constantly evolving furnishing concept, enriched with new elements to meet the needs of contemporary interior design. As for finishes, the most relevant innovation is the possibility of covering the back panels and the back of the elements with fabric, creating visual continuity with the boiserie, seamlessly integrating the Wall System with the Architectural system.





Nelle pagine precedenti e nella successiva: composizione Wall System, al centro, struttura, schienali e ripiani in olmo nero, cassettiere in olmo nero con interno in nobilitato ardesia e tecnocover Grain 07 roccia. A sinistra e a destra, struttura in olmo nero, ripiani in olmo nero con luce a led integrata, griglie in laccato metallico bronzo e schienali in olmo nero; mensole in laccato metallico bronzo con luce a led integrata e schienali in tessuto Mesh bronzo. Porte Pivot Side in vetro Rain écreu con telaio in olmo nero e maniglia Side ardesia opaco. Portale in laccato metallico bronzo e stipite ardesia opaco. In questa pagina: dettaglio dell'interno del cassetto in nobilitato ardesia e tecnocover Grain 07 roccia.

Previous pages and next page: Wall System composition, in the middle, structure, backs and shelves in black elm, chests of drawers in black elm with interior in ardesia melamine and tecnocover Grain 07 roccia. To the left and to the right, structure in black elm, shelves in black elm with integrated led light, grids in metallic lacquer bronzo and black elm backs; shelves in metallic lacquer bronzo with integrated led light and backs in fabric Mesh bronzo. Pivot Side doors in glass Rain écreu with black elm frame and mat ardesia Side handle. Portal in metallic lacquer bronzo and mat ardesia jamb. This page: close up of the interior of the drawer in ardesia melamine and tecnocover Grain 07 roccia.





In questa pagina: boiserie Surface in tessuto Mesh bronzo con profili ardesia opaco. Boiserie Surface in olmo nero print con profili ardesia opaco e mensole in laccato metallico bronzo.

This page: Surface boiserie in fabric Mesh bronzo with mat ardesia profiles. Surface boiserie in black elm print with mat ardesia profiles and shelves in metallic lacquer bronzo.

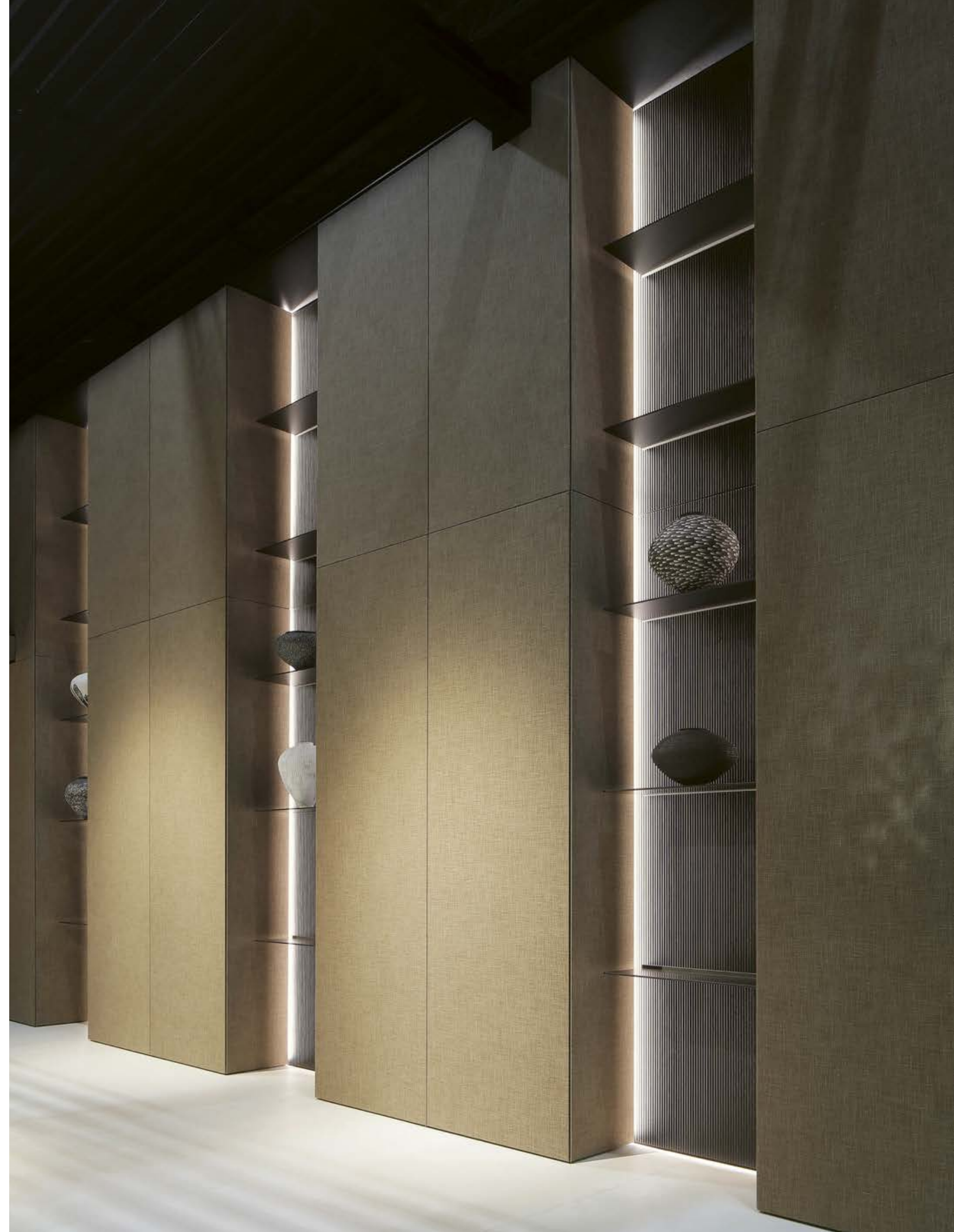



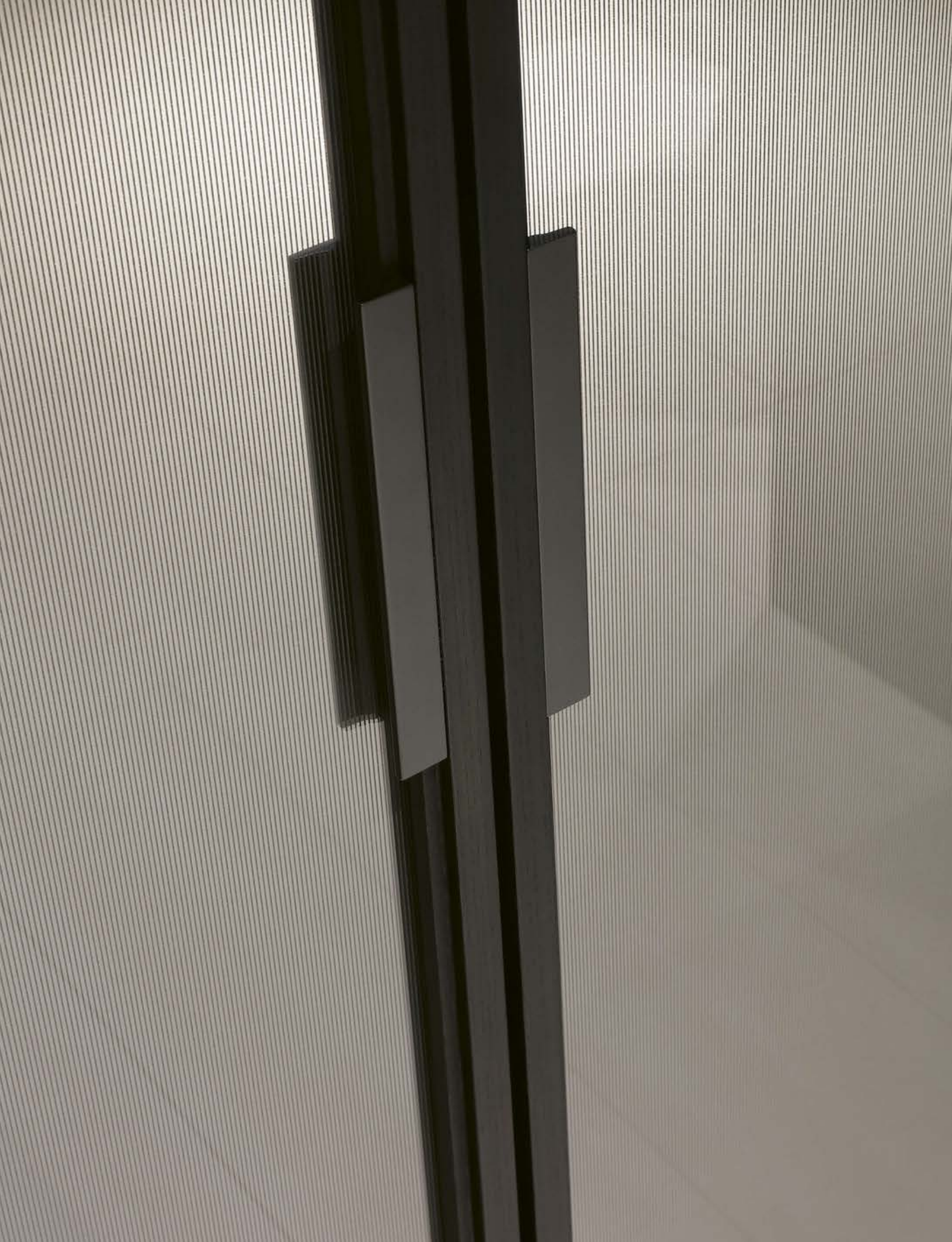

In questa pagina: dettaglio delle porte Pivot Side in vetro Rain écre con telaio in olmo nero e maniglia Side ardesia opaco.

This page: close up of Pivot Side doors in glass Rain écre with black elm frame and mat ardesia Side handle.

In questa pagina: dettaglio della composizione Wall System con struttura in olmo nero, ripiani in olmo nero con luce a led integrata, griglie in laccato metallico bronzo e schienali in olmo nero; mensole in laccato metallico bronzo con luce a led integrata e schienali in tessuto Mesh bronzo.

This page: close up of the Wall System composition with structure in black elm, shelves in black elm with integrated led light, grids in metallic lacquer bronzo and black elm backs; shelves in metallic lacquer bronzo with integrated led light and backs in fabric Mesh bronzo.





In questa pagina: sistema interparete Link con apertura rototraslante, pannelli in vetro bronzato con telaio e maniglia Plus champagne opaco, binario champagne opaco.

This page: Link partition system with rototranslating opening, panels in bronzed glass with mat champagne frame and Plus handle, mat champagne track.

In questa pagina: dettaglio del sistema interparete Link con apertura rototraslante, pannelli in vetro bronzato con telaio e maniglia Plus champagne opaco.

This page: close up of Link partition system with rototranslating opening, panels in bronzed glass with mat champagne frame and Plus handle.





Nella pagina precedente: composizione Wall System, a sinistra e a destra, struttura, ripiani e schienali in olmo nero, luce a led integrata; mensole in olmo nero con luce a led integrata e schienali in tessuto Mesh peltro. Contenitori con ante a ribalta in olmo nero con top in marmo zecevo levigato. Sistema interparete Link con apertura rototraslante, pannelli in vetro bronzato con telaio e maniglia Plus champagne opaco, binario champagne opaco. In questa pagina: dettaglio del contenitore in olmo nero con anta a ribalta e top in marmo zecevo levigato.

Previous page: Wall System composition, to the left and to the right, structure, shelves and backs in black elm, integrated led light; black elm shelves with integrated led light and backs in fabric Mesh peltro. Storage units with flap doors in black elm with top in mat zecevo marble. Link partition system with rototranslating opening, panels in bronzed glass with mat champagne frame and Plus handle, mat champagne track. This page: close up of the storage unit in black elm with flap door and top in mat zecevo marble.





In questa pagina: dettaglio dell'interno del contenitore con anta a ribalta. Interno in olmo nero con vassoio estraibile in laccato opaco bronzo e tecnocover Grain 07 roccia.

This page: close up of the interior of the storage unit with flap door. Interior in black elm with extractable tray in mat lacquer bronzo and tecnocover Grain 07 roccia.

WALL SYSTEM

Design R&D Poliform

Struttura: olmo nero.
Schienali: olmo nero e tessuto Mesh bronzo.
Ripiani: olmo nero.
Griglie: laccato metallico bronzo.
Cassettiere: olmo nero, interno nobilitato ardesia e tecnocover Grain 07 roccia.
Mensole: laccato metallico bronzo, spessore 8.
Luce a led integrata.

Structure: black elm.
Backs: black elm and fabric Mesh bronzo.
Shelves: black elm.
Grids: metallic lacquer bronzo.
Chests of drawers: black elm, ardesia melamine interior and tecnocover Grain 07 roccia
Shelves: metallic lacquer bronzo, thickness 1/4".
Integrated led light.

Porte Pivot Side

Portale: laccato metallico bronzo.
Stipite: ardesia opaco.
Porta Side: vetro Rain écru, telaio olmo nero.
Maniglia Side: ardesia opaco.

Pivot Side doors

Portal: metallic lacquer bronzo.
Jamb: mat ardesia.
Side door: glass Rain écru, black elm frame.
Side handle: mat ardesia.

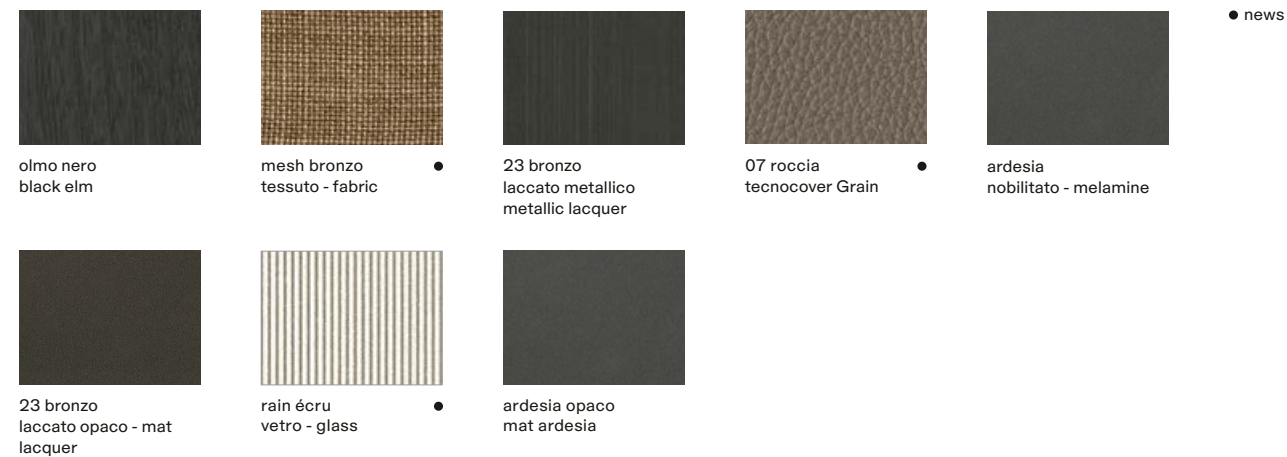
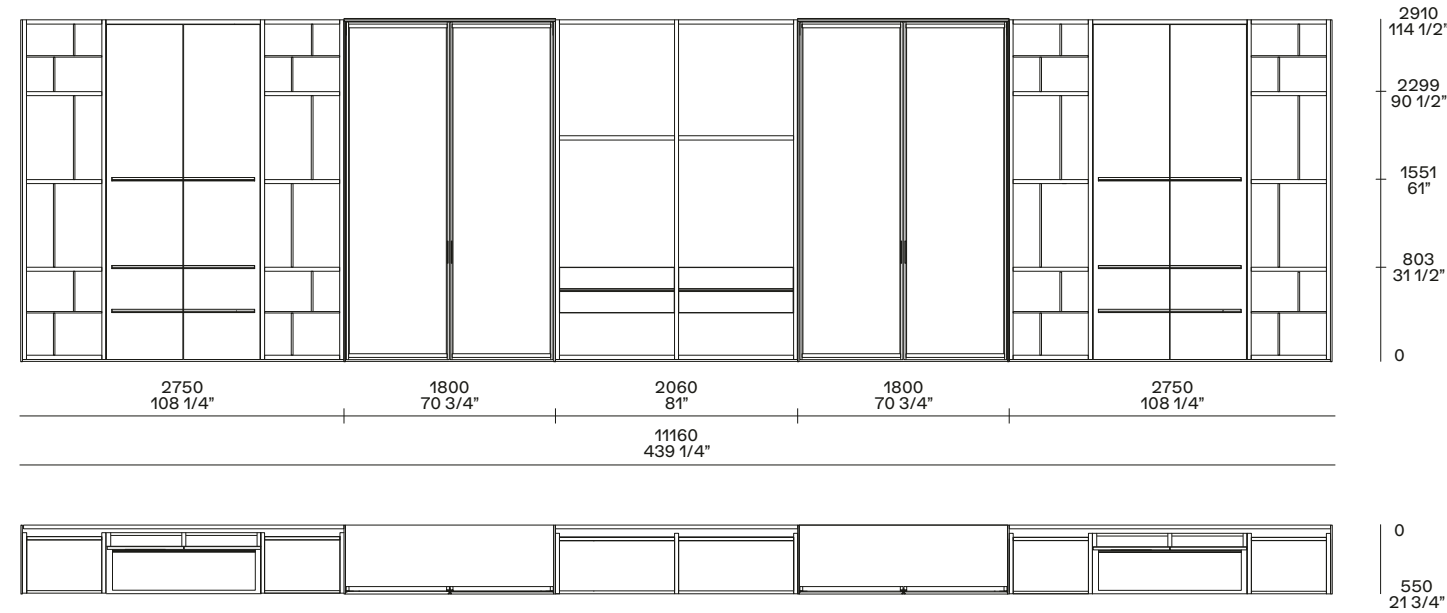

Struttura: olmo nero.
Schienali: olmo nero e tessuto Mesh peltro.
Ripiani: olmo nero.
Contenitori: ante a ribalta olmo nero, top marmo zecevo levigato.
Mensole: olmo nero, spessore 8.
Luce a led integrata.

Structure: black elm.
Backs: black elm and fabric Mesh peltro.
Shelves: black elm.
Storage units: black elm flap doors, mat zecevo marble top.
Shelves: black elm, thickness 1/4".
Integrated led light.

Link sistema interparete

Apertura rototraslante doppia, due ante.
Pannelli: vetro bronzato con telaio champagne.
Maniglia Plus: champagne opaco.
Binario: champagne opaco.

Link partition wall system

Double rototranslating opening, two doors.
Panels: bronzed glass with mat champagne frame.
Plus handle: mat champagne
Track: mat champagne.

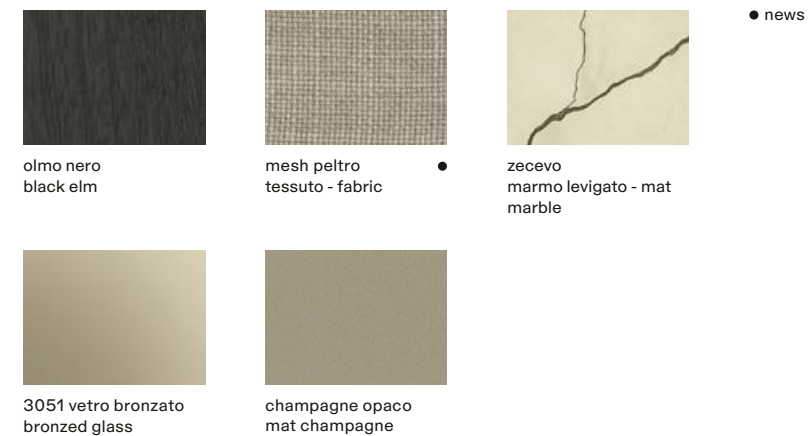
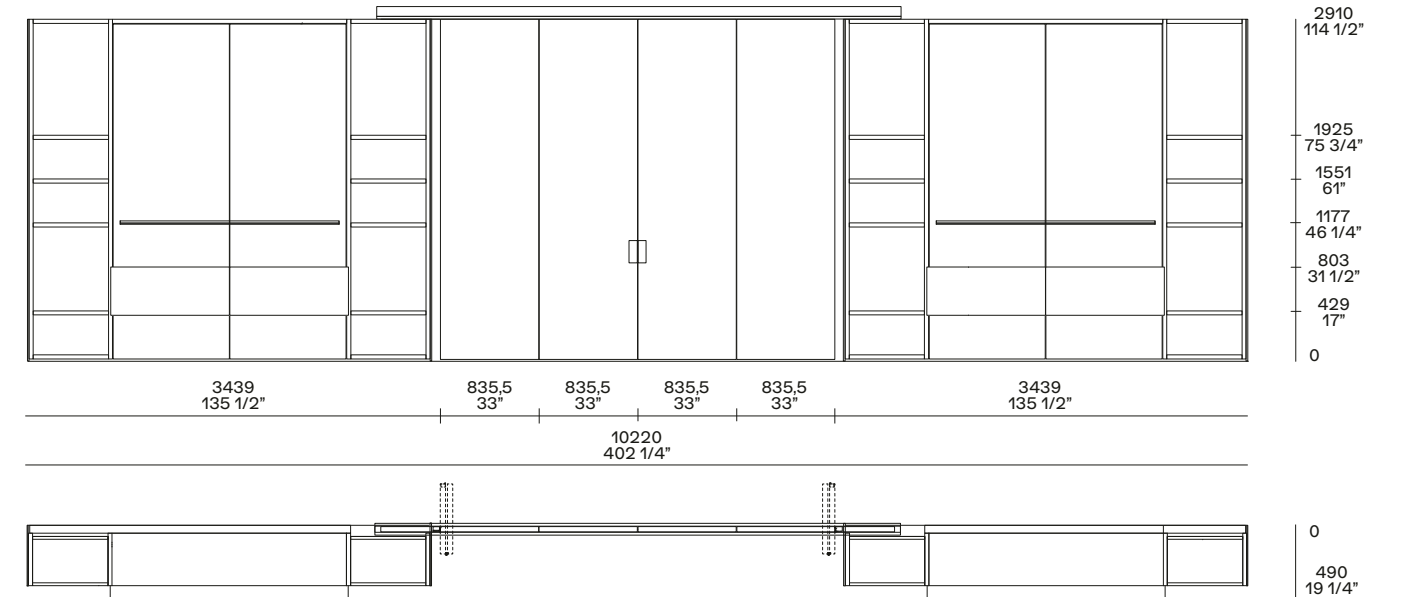



TRACE CARPET

Il tappeto Trace, in misto lana e seta di bambù, è prodotto con la tecnica del telaio jacquard. Dall'alternanza tra il bouclé della base e vello pettinato nasce il particolare disegno, disponibile in due colori.

The Trace carpet, made from a blend of wool and bamboo silk, is produced using Jacquard weaving. The distinctive pattern, available in two colors, comes from the alternation of the loop boucle of the base and the combed fleece.





TRACE

Design R&D Poliform

Prodotto a mano con tecnica handloom jacquard.
Vello in lana himalayana e seta di bambù.
Dimensioni mm: rettangolare 1700×2400
2300×3000 - 3000×4000
quadrato 3000×3000 - rotondo Ø 2500.

Handmade with the jacquard handloom technique.
Pile in Hymalayan wool and bamboo silk.
Dimensions inches: rectangular
67"x94 1/2" - 90 1/2"x118" - 118"x157 1/2"
square 118"x118" - round Ø 98 1/2".



White



Écru

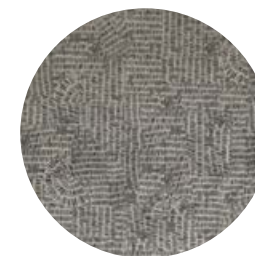



NEW INDOOR FABRICS

Poliform invita a interpretare il rivestimento come possibilità estetica e veicolo di sensazioni visive e tattili. Per gusto, cromie e matericità, la collezione 2024 si ispira al mondo della moda. Ai tessuti bouclé d'ispirazione haute couture si affiancano tessuti morbidi e piacevoli al tatto, con vello pettinato o dall'effetto teddy, di grande impatto visivo. Anche le pelli, nelle due versioni scamosciata e pieno fiore, sono equiparabili per look, mano e performance alle pelli abitualmente destinate al mondo moda. Sempre coerente ai prodotti presentati, la ricerca sulle finiture si conferma dunque centrale, in linea con un'idea di lifestyle che fa della qualità dell'esperienza, anche tattile, il suo punto di forza.

Poliform invites to interpret upholstery as an aesthetic possibility and a vehicle for visual and tactile sensations. In terms of style, colour palette and textures, the 2024 collection draws inspiration from the world of fashion. Visually stunning haute couture-inspired boucle fabrics coexist with soft fabrics, combed or teddy pile, that are pleasant to the touch. Even the suede and full-grain leathers are comparable in look, workmanship and performance to the leathers usually reserved for the fashion world. Consistently with all the products on offer, the research on finishes remains central, in line with a lifestyle concept that puts quality of experience, including tactile experience, front and center.



NUOVI TESSUTI INDOOR
NEW INDOOR FABRICS

Altair
fabric cat. e



Polar
fabric cat. e



Mizar
fabric cat. e

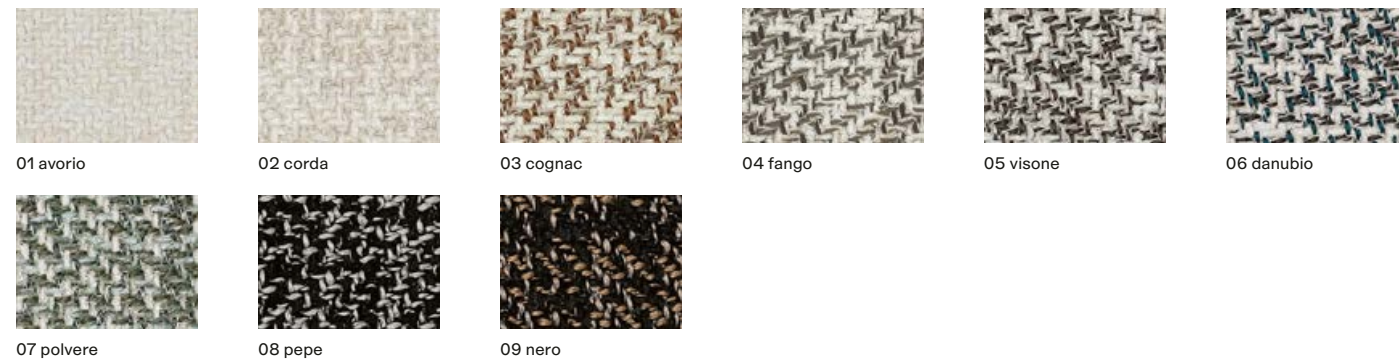

Hamal
fabric cat. g

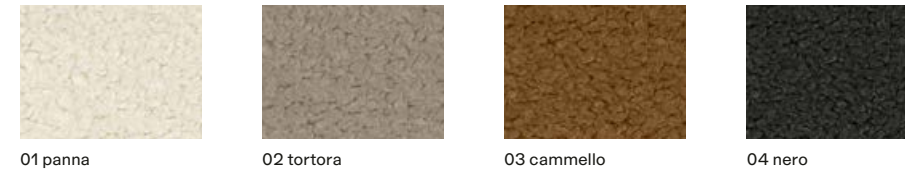

Mintaka
fabric cat. m

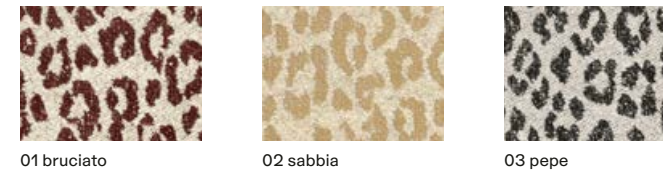

Shedir
fabric cat. e

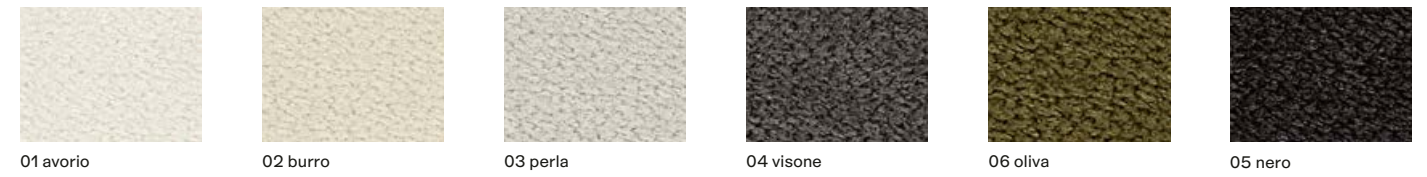

Pelle Suede
leather cat. x

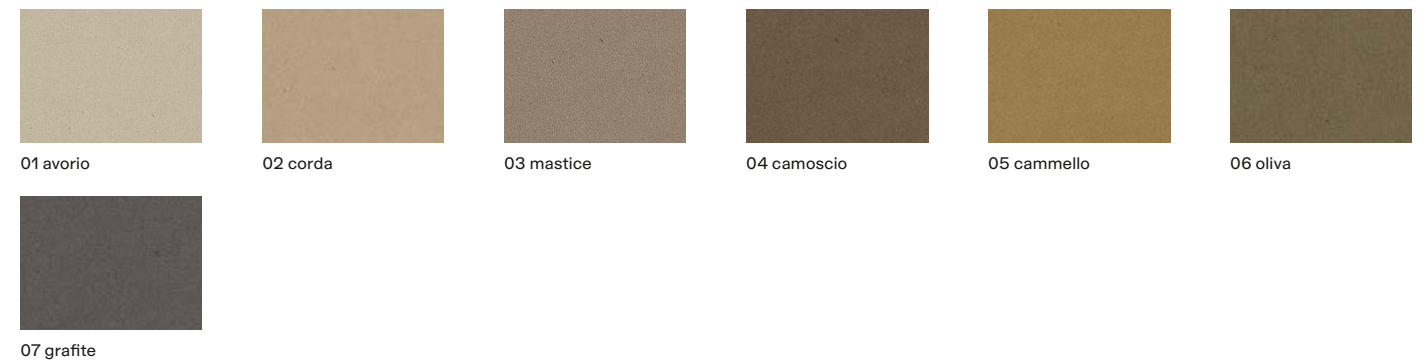

Pelle Natural
leather cat. y

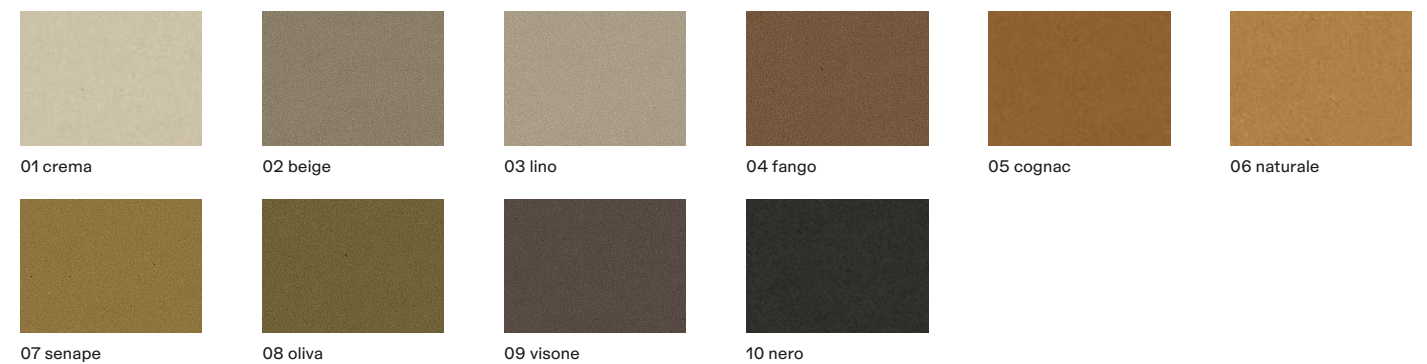

SOFA COMPOSITIONS

ERNEST COMPOSITION 01	338
ERNEST COMPOSITION 02	342
ERNEST COMPOSITION 03	346
ERNEST COMPOSITION 04	350
ERNEST COMPOSITION 05	354
ERNEST COMPOSITION 06	358
ERNEST COMPOSITION 07	362
ERNEST COMPOSITION 08	366
ERNEST COMPOSITION 09	370
ERNEST COMPOSITION 10	374
ORBIS COMPOSITION 01	378
ORBIS COMPOSITION 02	382
ORBIS COMPOSITION 03	386



COMPOSITION 01

1 Ernest divano

Rivestimento in tessuto sfoderabile
Shedir 06 oliva.
Tavolino retrodivano in olmo nero.
Composizione l 3700 p 1010-1750

2 Ernest poltrona

Rivestimento in pelle sfoderabile
Natural 10 nero.
l 1000 p 1010 h 670

3 Ernest tavolini

Piano e gambe in laccato lucido moka.
1200x900 h 300
Ø 600 h 400
Piano e gambe in olmo nero.
1200x700 h 300

4 Trace tappeto

Colore white.
Dimensioni su misura 6000x4500

1 Ernest sofa

Cover in removable fabric Shedir
06 oliva.
Sofa rear table in black elm.
Composition w 145 3/4" d 39 3/4"-69"

2 Ernest armchair

Cover in removable leather Natural
10 nero.
w 39 1/4" d 39 3/4" h 26 1/4"

3 Ernest coffee tables

Top and legs in moka glossy lacquer.
47 1/4"x35 1/2" h 11 3/4"
Ø 23 1/2" h 15 3/4"
Top and legs in black elm.
47 1/4"x27 1/2" h 11 3/4"

4 Trace carpet

Colour white.
Customized sizes 236 1/4"x177 1/4"

**Ernest divano
Ernest sofa**

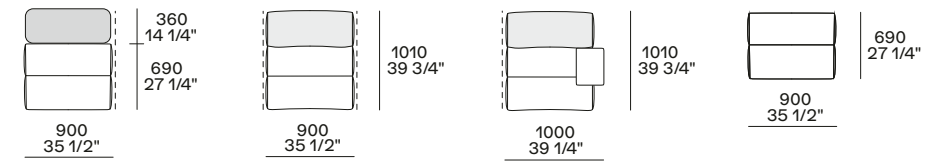

**Ernest poltrona
Ernest armchair**

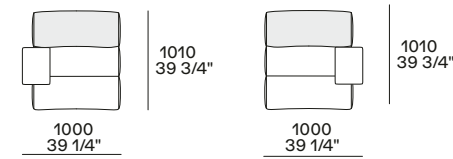

**Ernest tavolini
Ernest coffee tables**

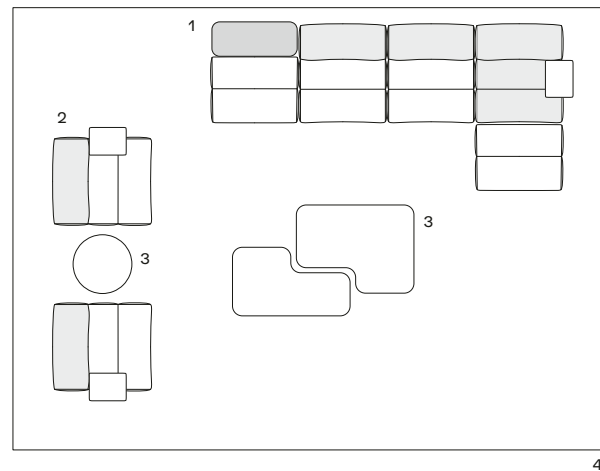
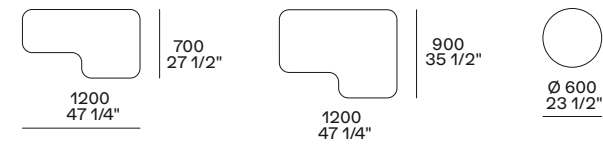

4

Display 30 mq-sqm



shedir 06 oliva
tessuto - fabric



olmo nero
black elm

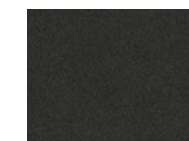

natural 10 nero
pelle - leather



49 moka
laccato lucido - glossy
lacquer

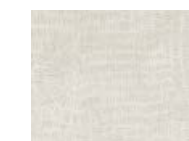

tappeto Trace white
carpet Trace white



COMPOSITION 02

1 Ernest divano ad angolo

Rivestimento in tessuto sfoderabile Shedir 01 avorio.
Tavolino ad angolo in marmo travertino titanium levigato.
Composizione l 3710 p 2910

1 Ernest corner sofa

Cover in removable fabric Shedir 01 avorio.
Corner coffee table in mat marble travertino titanium.
Composition w 146" d 114 1/2"

2 Ernest divano

Rivestimento in pelle sfoderabile Nabuk 02 tortora.
Composizione l 1900 p 1010

2 Ernest sofa

Cover in removable leather Nabuk 02 tortora.
Composition w 74 3/4" d 39 3/4"

3 Ernest tavolini

Piano e gambe in laccato lucido granata.
1200x700 h 300
1200x900 h 300
Piano e gambe in marmo travertino titanium levigato.
Ø 600 h 400

3 Ernest coffee tables

Top and legs in granata glossy lacquer.
47 1/4"x27 1/2" h 11 3/4"
47 1/4"x35 1/2" h 11 3/4"
Top and legs in mat marble travertino titanium.
Ø 23 1/2" h 15 3/4"

4 Trace tappeto

Colore écru.
Dimensioni su misura 6000x4000

4 Trace carpet

Colour ecru.
Customized sizes 236 1/4"x157 1/2"

**Ernest divano ad angolo
Ernest corner sofa**

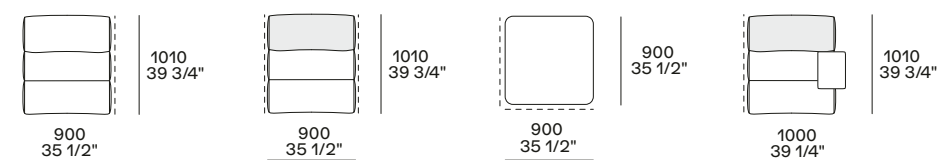

**Ernest divano
Ernest sofa**

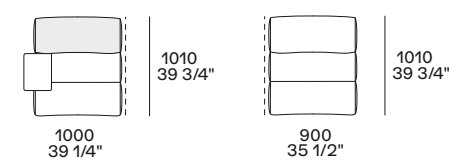

**Ernest tavolini
Ernest coffee tables**

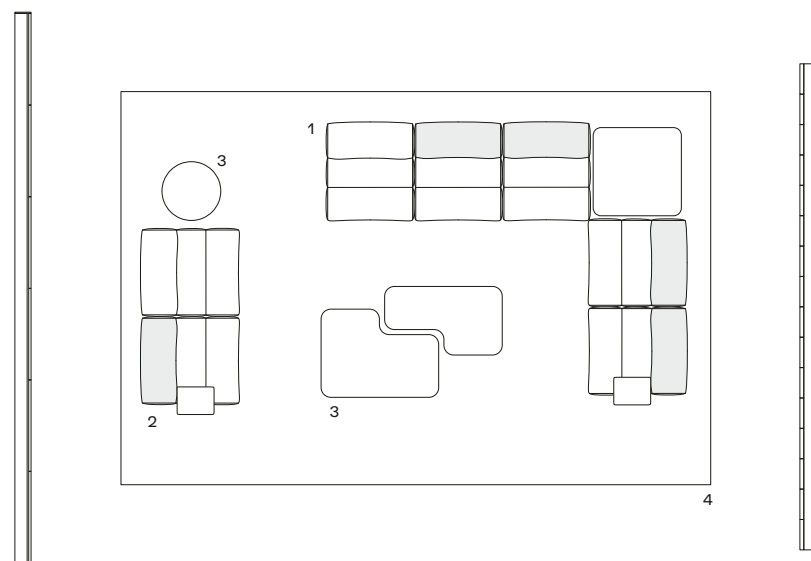
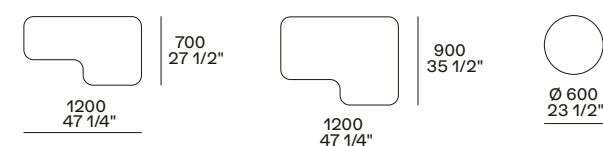

Display 25 mq-sqm





COMPOSITION 03

1 Ernest divano
 Rivestimento in tessuto sfoderabile Shedir 03 perla.
 Tavolino retrodivano in olmo nero.
 Composizione l 2800 p 1010

2 Ernest poltrona
 Rivestimento in pelle sfoderabile Natural 04 fango.
 l 1000 p 1010 h 670

3 Ernest tavolini
 Piano e gambe in marmo travertino titanium levigato.
 1200x700 h 300
 1200x900 h 300
 Piano e gambe in olmo nero.
 Ø 600 h 400

4 Trace tappeto
 Colore écru.
 Dimensioni su misura 6000x4500

1 Ernest sofa
 Cover in removable fabric Shedir 03 perla.
 Sofa rear table in black elm.
 Composition w 110 1/4" d 39 3/4"

2 Ernest armchair
 Cover in removable leather Natural 04 fango.
 w 39 1/4" d 39 3/4" h 26 1/4"

3 Ernest coffee tables
 Top and legs in mat marble travertino titanium.
 47 1/4"x27 1/2" h 11 3/4"
 47 1/4"x35 1/2" h 11 3/4"
 Top and legs in black elm.
 Ø 23 1/2" h 15 3/4"

4 Trace carpet
 Colour ecru.
 Customized sizes 236 1/4"x177 1/4"

**Ernest divano
 Ernest sofa**

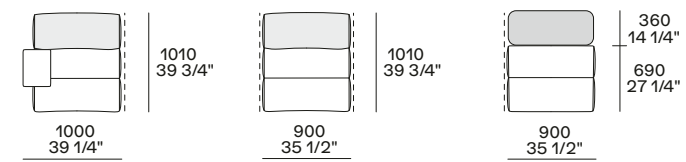

**Ernest poltrona
 Ernest armchair**

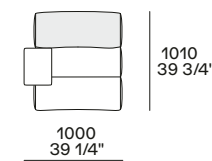

**Ernest tavolini
 Ernest coffee tables**

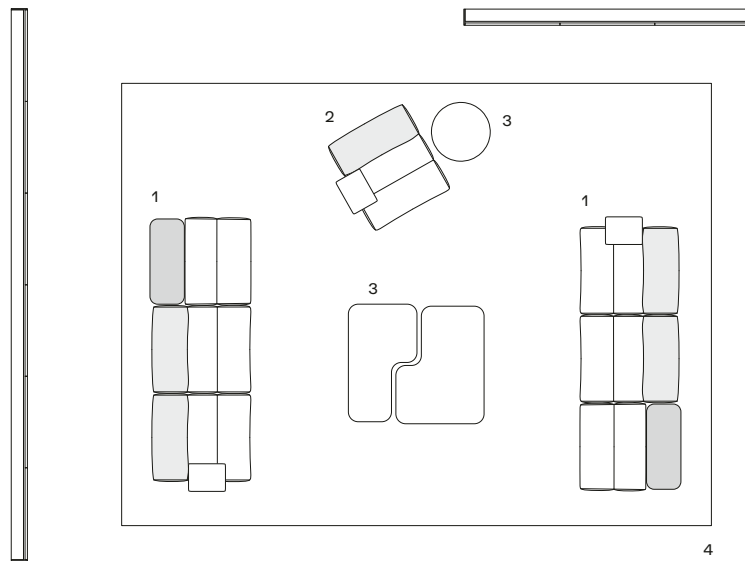
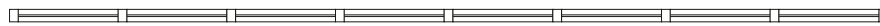
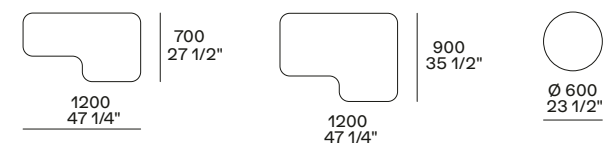

Display 30 mq-sqm



shedir 03 perla
 tessuto - fabric



olmo nero
 black elm

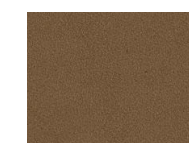

natural 04 fango
 pelle - leather



travertino titanium
 marmo levigato
 mat marble



tappeto Trace écru
 carpet Trace ecru



COMPOSITION 04

1 Ernest divano
Rivestimento in velluto sfoderabile
Glasgow 01 crema.
Composizione l 2900 p 1010

2 Ernest divano
Rivestimento in pelle sfoderabile
Nabuk 01 latte.
Composizione l 1900 p 1010

3 Ernest chaise longue
Rivestimento in pelle sfoderabile
Nabuk 01 latte.
poltrona l 1000 p 1010 h 670
pouf l 900 p 690 h 370

4 Ernest tavolini
Piano e gambe in marmo travertino
classico levigato.
890x900 h 300
Piano e gambe in olmo nero.
Ø 600 h 400

5 Trace tappeto
Colore white.
Dimensioni su misura 6000x4500

1 Ernest sofa
Cover in removable velvet Glasgow
01 crema.
Composition w 114 1/4" d 39 3/4"

2 Ernest sofa
Cover in removable leather Nabuk
01 latte.
Composition w 74 3/4" d 39 3/4"

3 Ernest chaise longue
Cover in removable leather Nabuk
01 latte.
armchair w 39 1/4" d 39 3/4" h 26 1/4"
pouf w 35 1/2" d 27 1/4" h 14 1/2"

4 Ernest coffee tables
Top and legs in mat marble
travertino classico.
35"x35 1/2" h 11 3/4"
Top and legs in black elm.
Ø 23 1/2" h 15 3/4"

5 Trace carpet
Colour white.
Customized sizes 236 1/4"x177 1/4"

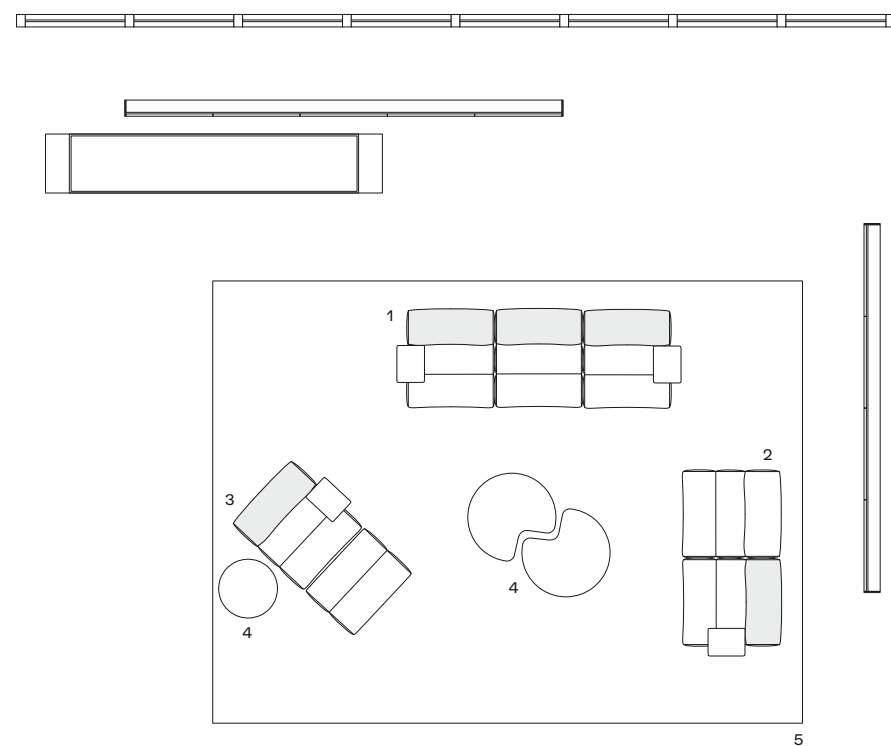
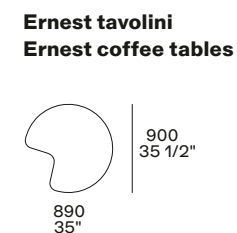
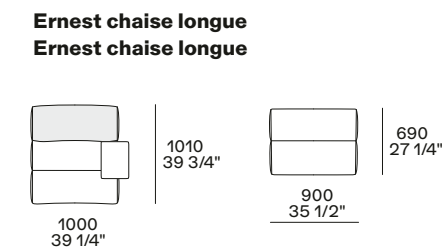
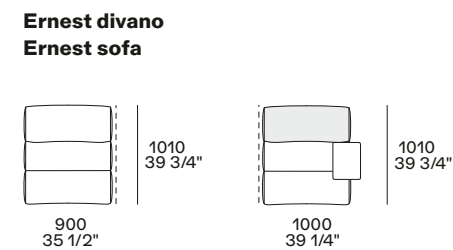
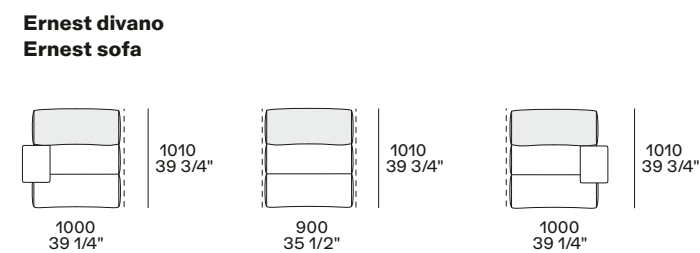

Display 30 mq-sqm





COMPOSITION 05

1 Ernest divano
 Rivestimento in pelle sfoderabile
 Natural 10 nero.
 Tavolino retrodivano in olmo nero.
 Composizione l 3770 p 1850

2 Ernest tavolini
 Piano e gambe in marmo travertino
 titanium levigato.
 890x900 h 300
 Ø 600 h 400

3 Trace tappeto
 Colore white.
 Dimensioni su misura Ø 5000

1 Ernest sofa
 Cover in removable leather Natural
 10 nero.
 Sofa rear table in black elm.
 Composition w 148 1/2" d 72 3/4"

2 Ernest coffee tables
 Top and legs in mat marble travertino
 titanium.
 35"x35 1/2" h 11 3/4"
 Ø 23 1/2" h 15 3/4"

3 Trace carpet
 Colour white.
 Customized sizes Ø 196 3/4"

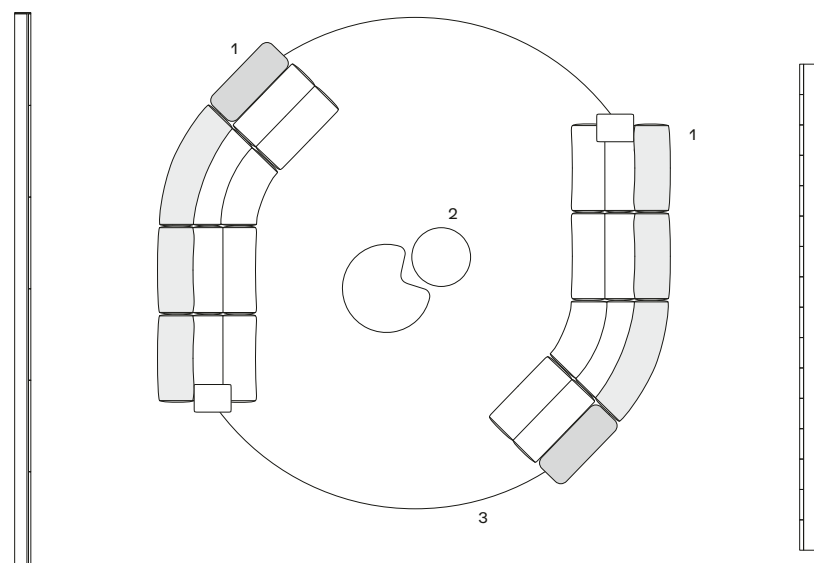
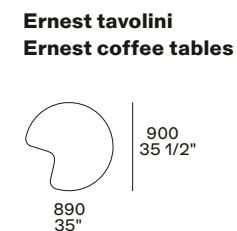
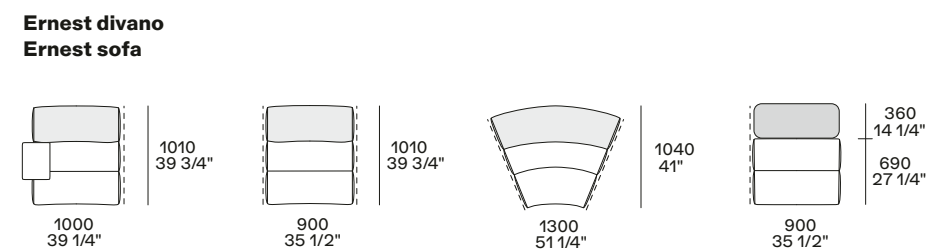

Display 30 mq-sqm

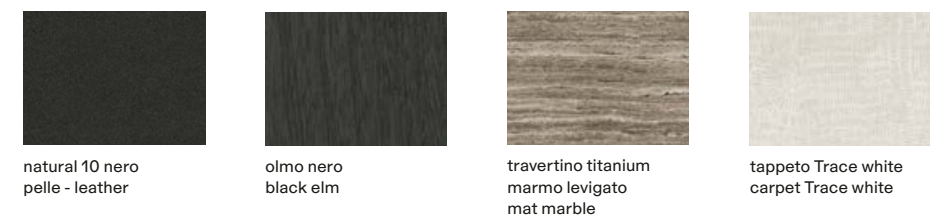



COMPOSITION 06

1 Ernest divano

Rivestimento in pelle sfoderabile Natural 05 cognac.
Tavolino terminale in olmo nero.
Composizione l 4590 p 1850

2 Ernest poltrona

Rivestimento in tessuto sfoderabile Shedir 03 perla.
l 1000. p 1010 h 670

3 Ernest tavolini

Piano e gambe in marmo travertino titanium levigato.
890x900 h 300
Ø 600 h 400
Piano e gambe in olmo nero.
Ø 600 h 400

4 Trace tappeto

Colore white.
Dimensioni su misura Ø 5000

1 Ernest sofa

Cover in removable leather Natural 05 cognac.
End coffee table in black elm.
Composition w 180 3/4" d 72 3/4"

2 Ernest armchair

Cover in removable fabric Shedir 03 perla.
w 39 1/4" d 39 3/4" h 26 1/4"

3 Ernest coffee tables

Top and legs in mat marble travertino titanium.
35"x35 1/2" h 11 3/4"
Ø 23 1/2" h 15 3/4"
Top and legs in black elm.
Ø 23 1/2" h 15 3/4"

4 Trace carpet

Colour white.
Customized sizes Ø 196 3/4"

**Ernest divano
Ernest sofa**

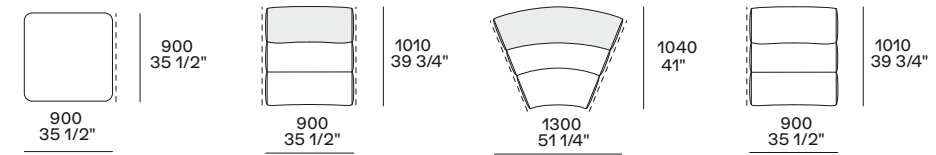

**Ernest poltrona
Ernest armchair**

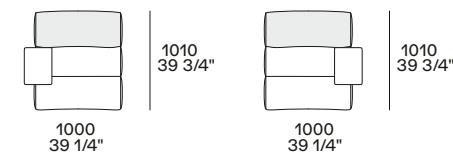

**Ernest tavolini
Ernest coffee tables**

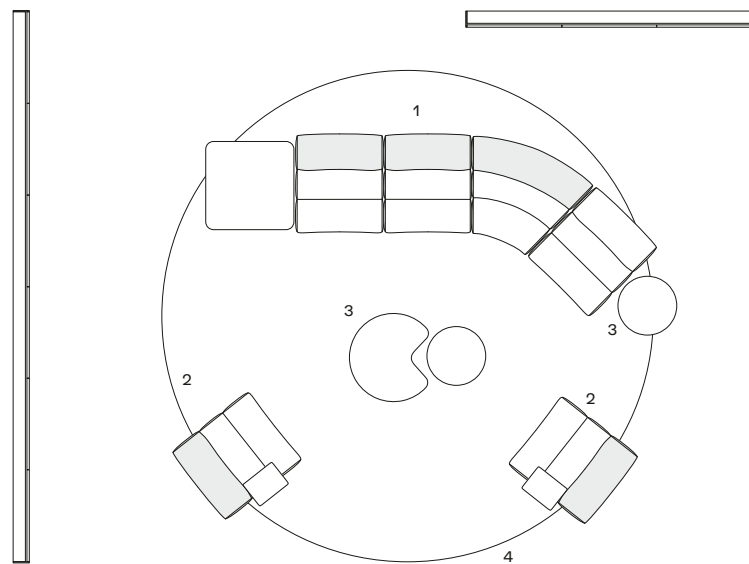
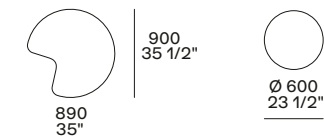

Display 30 mq-sqm





COMPOSITION 07

1 Ernest divano
Rivestimento in tessuto sfoderabile
Naxos 17 corda.
Composizione l 4260 p 1210

2 Ernest chaise longue
Rivestimento in pelle sfoderabile
Natural 07 senape.
poltrona l 1000 p 1010 h 670
pouf l 900 p 690 h 370

3 Ernest pouf
Rivestimento in tessuto sfoderabile
Naxos 17 corda.
l 900 p 1010 h 370

4 Ernest tavolini
Piano e gambe in olmo nero.
890x900 h 300
Ø 600 h 400

5 Trace tappeto
Colore écreu.
Dimensioni su misura Ø 5000

1 Ernest sofa
Cover in removable fabric Naxos
17 corda.
Composition w 167 3/4" d 47 3/4"

2 Ernest chaise longue
Cover in removable leather Natural
07 senape.
armchair w 39 1/4" d 39 3/4" h 26 1/4"
pouf w 35 1/2" d 27 1/4" h 14 1/2"

3 Ernest pouf
Cover in removable fabric Naxos
17 corda.
w 35 1/2" d 39 3/4" h 14 1/2"

4 Ernest coffee tables
Top and legs in black elm.
35"x35 1/2" h 11 3/4"
Ø 23 1/2" h 15 3/4"

5 Trace carpet
Colour ecru.
Customized sizes Ø 196 3/4"

**Ernest divano
Ernest sofa**

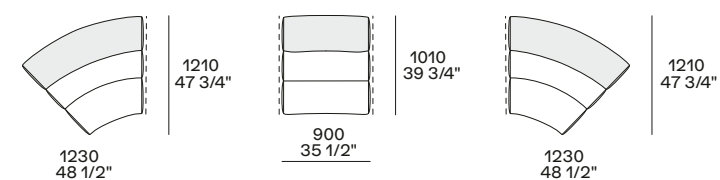

**Ernest chaise longue
Ernest chaise longue**

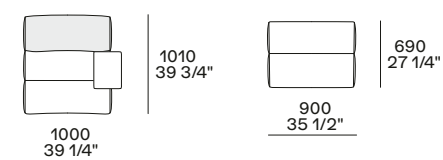

**Ernest pouf
Ernest pouf**

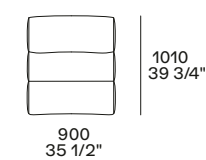

**Ernest tavolini
Ernest coffee tables**

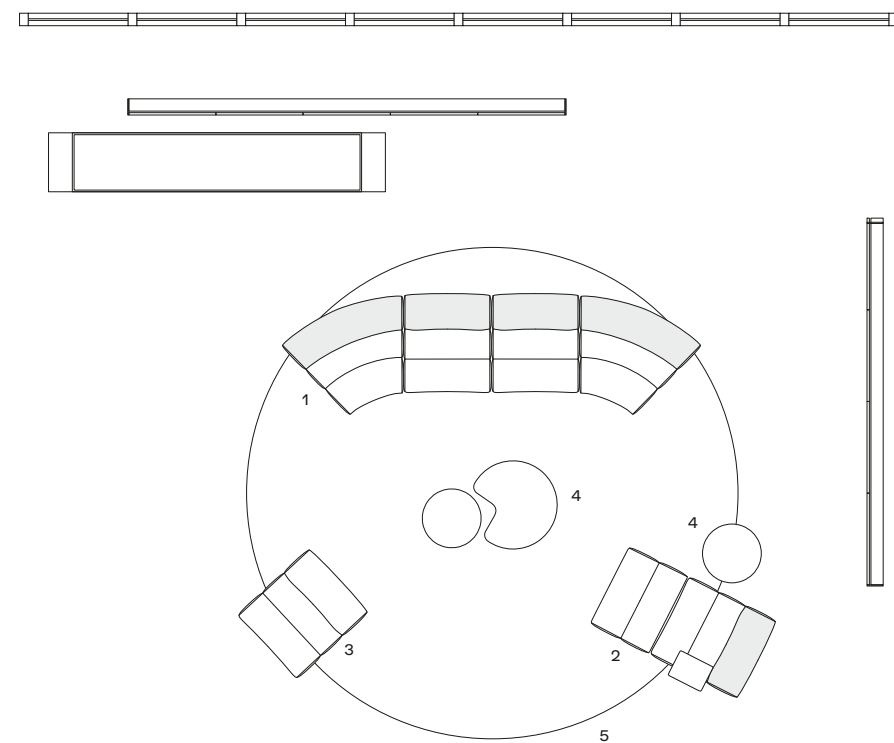

Display 30 mq-sqm



naxos 17 corda
tessuto - fabric

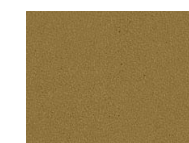

natural 07 senape
pelle - leather



olmo nero
black elm



tappeto Trace écreu
carpet Trace ecru



COMPOSITION 08

1 Ernest divano

Rivestimento in tessuto sfoderabile Yukon 27 tabacco.
Tavolino retrodivano in marmo levigato travertino classico.
Composizione l 3800 p 1050

1 Ernest sofa

Cover in removable fabric Yukon 27 tabacco.
Sofa rear table in mat marble travertino classico.
Composition w 149 1/2" d 41 1/4"

2 Ernest poltrona

Rivestimento in pelle sfoderabile Natural 03 lino.
l 1000 p 1010 h 670

2 Ernest armchair

Cover in removable leather Natural 03 lino.
w 39 1/4" d 39 3/4" h 26 1/4"

3 Ernest tavolini

Piano e gambe in olmo nero.
890x900 h 300
Ø 600 h 400

3 Ernest coffee tables

Top and legs in black elm.
35"x35 1/2" h 11 3/4"
Ø 23 1/2" h 15 3/4"

4 Trace tappeto

Colore écru.
Dimensioni su misura 6000x4500

4 Trace carpet

Colour ecru.
Customized sizes 236 1/4"x177 1/4"

**Ernest divano
Ernest sofa**

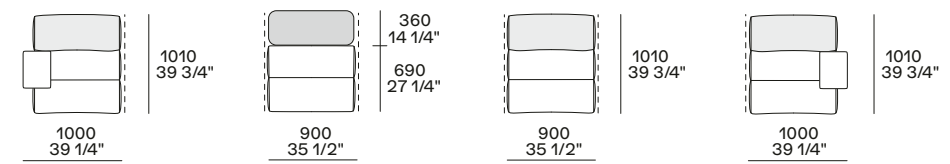

**Ernest poltrona
Ernest armchair**

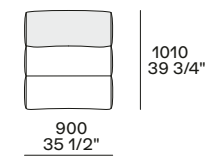

**Ernest tavolini
Ernest coffee tables**

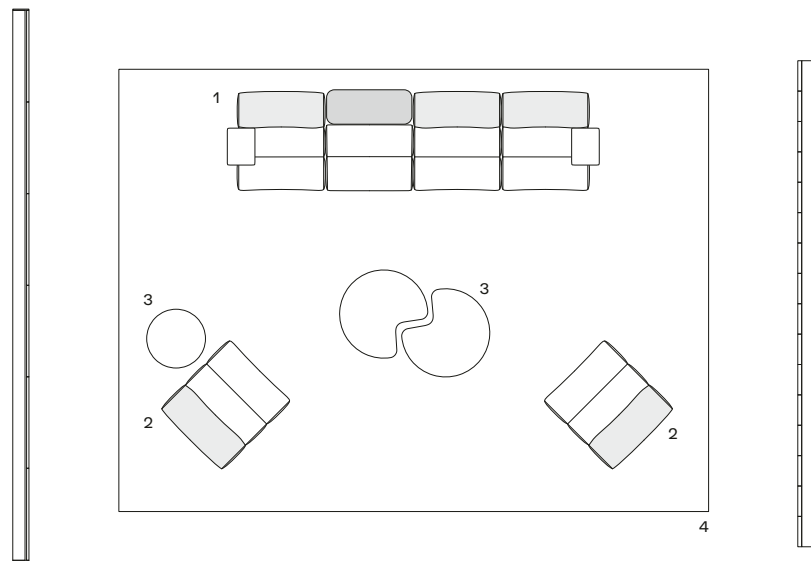
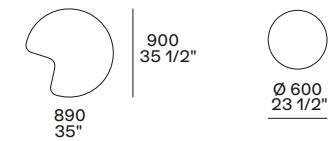

Display 30 mq-sqm

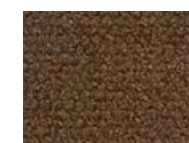

yukon 27 tabacco
tessuto - fabric

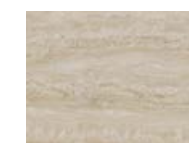

travertino classico
marmo levigato
mat marble

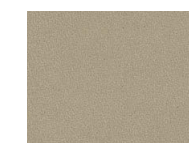

natural 03 lino
pelle - leather

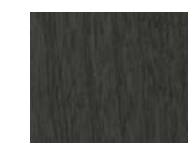

olmo nero
black elm



tappeto Trace écru
carpet Trace ecru



COMPOSITION 09

1 Ernest divano
 Rivestimento in tessuto sfoderabile
 Shedir 05 nero.
 Tavolino retrodivano e tavolino terminale
 in laccato lucido carbone.
 Composizione l 4050 p 3650

2 Ernest chaise longue
 Rivestimento in pelle sfoderabile
 Natural 08 oliva.
 poltrona l 1000 p 1010 h 670
 pouf l 900 p 690 h 370

3 Ernest tavolini
 Piano e gambe in marmo travertino
 titanium levigato.
 1200x700 h 300
 1200x900 h 300
 Ø 600 h 400

4 Trace tappeto
 Colore white.
 Dimensioni su misura 6500x4500

1 Ernest sofa
 Cover in removable fabric Shedir
 05 nero.
 Sofa rear table and end coffee table in
 carbone glossy lacquer.
 Composition w 159 1/2" d 143 3/4"

2 Ernest chaise longue
 Cover in removable leather Natural
 08 oliva.
 armchair w 39 1/4" d 39 3/4" h 26 1/4"
 pouf w 35 1/2" d 27 1/4" h 14 1/2"

3 Ernest coffee tables
 Top and legs in mat marble
 travertino titanium.
 47 1/4"x27 1/2" h 11 3/4"
 47 1/4"x35 1/2" h 11 3/4"
 Ø 23 1/2" h 15 3/4"

4 Trace carpet
 Colour white.
 Customized sizes 256"x177 1/4"

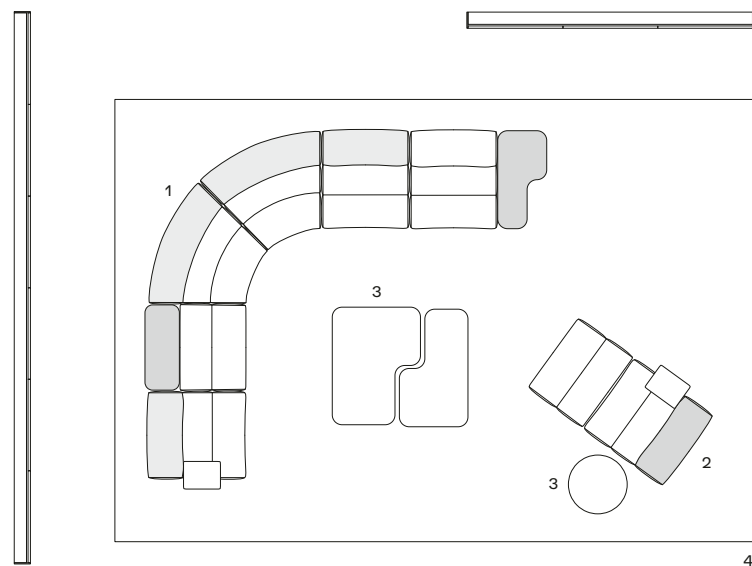
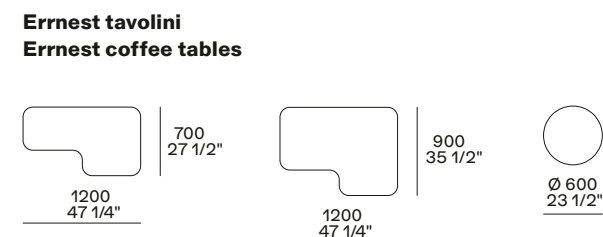
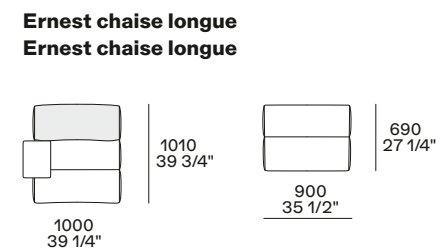
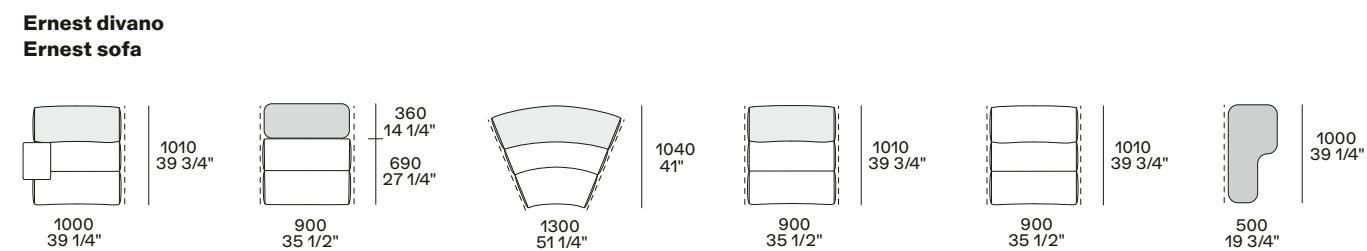

Display 30 mq-sqm





COMPOSITION 10

1 Ernest divano
 Rivestimento in tessuto sfoderabile Shedir 06 oliva.
 Tavolino retrodivano in olmo nero.
 Composizione l 5500 p 1010-1750-2490

2 Ernest tavolino
 Piano e gambe in marmo travertino titanium levigato.
 890x900 h 300

3 Trace tappeto
 Colore écreu.
 Dimensioni su misura 6000x4500

1 Ernest sofa
 Cover in removable fabric Shedir 06 oliva.
 Sofa rear table in black elm.
 Composition w 216 1/2" d 39 3/4"-69"-98"

2 Ernest coffee table
 Top and legs in mat marble travertino titanium.
 35"x35 1/2" h 11 3/4"

3 Trace carpet
 Colour ecru.
 Customized sizes 236 1/4"x177 1/4"

Ernest divano, composizione bifacciale
Ernest sofa, double-sided composition

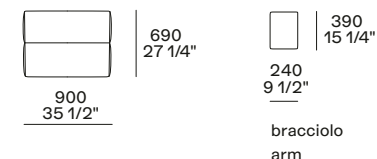
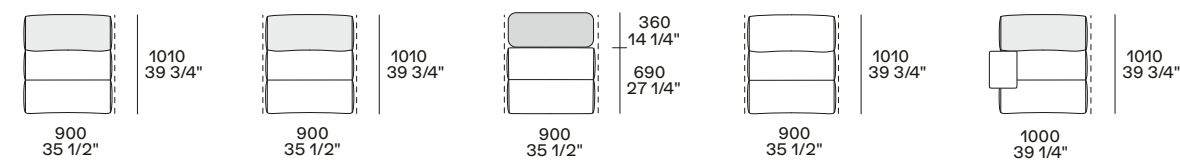

Ernest tavolino
Ernest coffee table

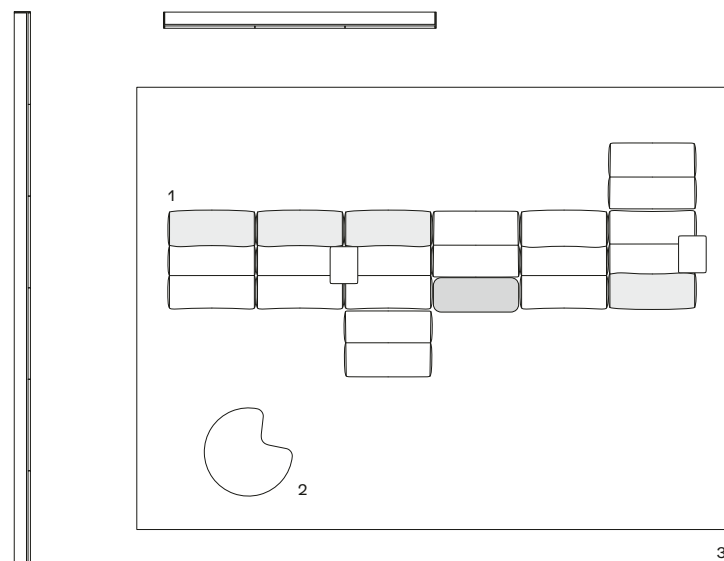
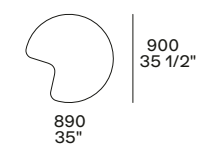

Display 30 mq-sqm

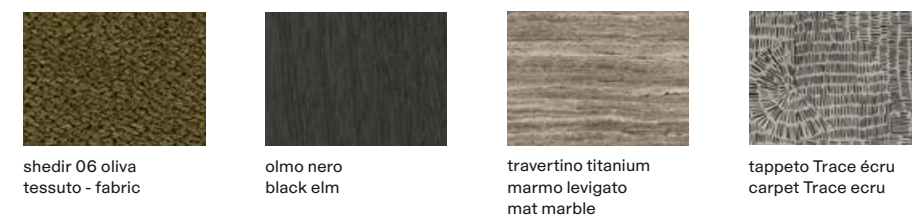



COMPOSITION 01

1 Orbis divano

Rivestimento in pelle sfoderabile Nabuk 02 tortora. Cuscini schienale in pelle sfoderabile Nabuk 02 tortora, cuscino opzionale in tessuto sfoderabile Altair 03 tortora.
Piedini in metallo light sheer lucido.
l 2220 p 1010 h 690-835

1 Orbis sofa

Cover in removable leather Nabuk 02 tortora. Back cushions in removable leather Nabuk 02 tortora, optional cushion in removable fabric Altair 03 tortora.
Feet in glossy metal light sheer.
w 87 1/4" d 39 3/4" h 27 1/4"-32 3/4"

2 Orbis poltrona

Rivestimento in tessuto sfoderabile Hamal 01 panna. Cuscino schienale in tessuto sfoderabile Hamal 01 panna.
Piedini in metallo light sheer lucido.
l 860 p 770 h 690

2 Orbis armchair

Cover in removable fabric Hamal 01 panna. Back cushion in removable fabric Hamal 01 panna.
Feet in glossy metal light sheer.
w 33 3/4" d 30 1/4" h 27 1/4"

3 Strata tavolini

Piano in marmo sahara noir levigato finitura poliesteri, gambe in olmo nero, olmo nero.
1390x900 h 280
Ø 1000 h 340
Piano in vetrofusione fumé, gamba in olmo nero.
Ø 470 h 485

3 Strata coffee tables

Top in mat marble sahara noir with polyester finish, legs in black elm.
54 3/4"x35 1/2" h 11"
Ø 39 1/4" h 13 1/2"
Top in fumé fused glass, leg in black elm.
Ø 18 1/2" h 19"

4 Shindo tappeto

Colore natural.
Dimensioni su misura 6000x4000

4 Shindo carpet

Colour natural.
Customized sizes 236 1/4"x157 1/2"

**Orbis divano
Orbis sofa**

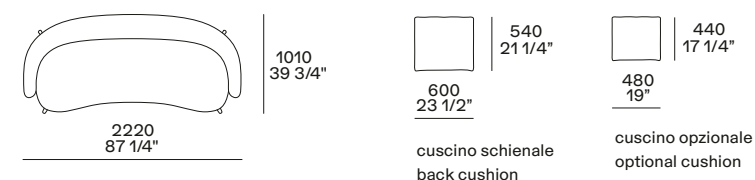

**Orbis poltrona
Orbis armchair**

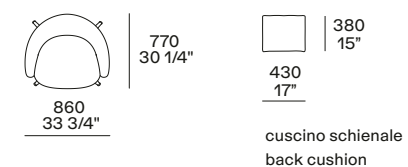

**Strata tavolini
Strata coffee tables**

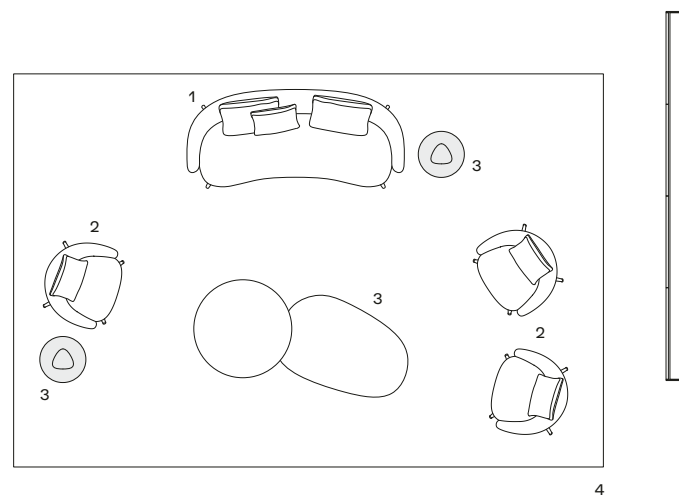
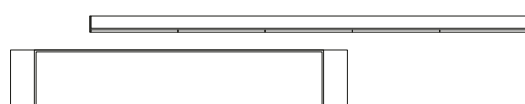
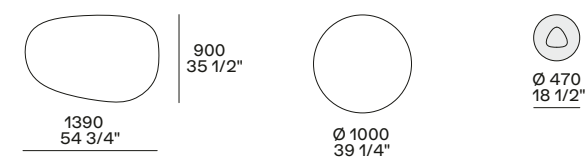

Display 25 mq-sqm

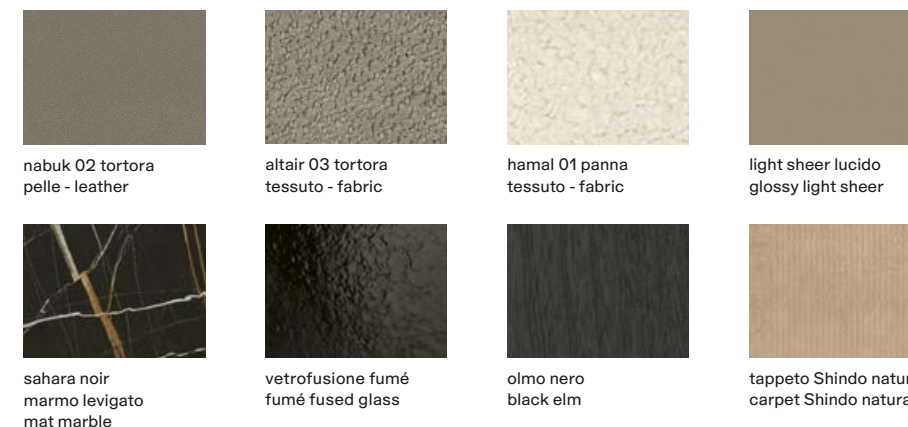



COMPOSITION 02

1 Orbis divano inclinato

Rivestimento in velluto sfoderabile Persia 1404 carbone. Cuscini schienale in velluto sfoderabile Persia 1404 carbone, cuscini opzionali in tessuto sfoderabile Mizar 04 fango.
Piedini in metallo dark sheer lucido.
l 2625 p 1450 h 690-835

1 Orbis angled sofa

Cover in removable velvet Persia 1404 carbone. Back cushions in removable velvet Persia 1404 carbone, optional cushions in removable fabric Mizar 04 fango.
Feet in glossy metal dark sheer.
w 103 1/2" d 57" h 27 1/4"-32 3/4"

2 Orbis poltrona

Rivestimento in pelle sfoderabile Suede 02 corda. Cuscino schienale in pelle sfoderabile Suede 02 corda.
Piedini in metallo dark sheer lucido.
l 860 p 770 h 690

2 Orbis armchair

Cover in removable leather Suede 02 corda. Back cushion in removable leather Suede 02 corda.
Feet in glossy metal dark sheer.
w 33 3/4" d 30 1/4" h 27 1/4"

3 Strata tavolini

Piano in vetrofusione bronzo, gambe in olmo nero.
1390x900 h 280
Piano e gamba in marmo travertino classico levigato.
Ø 470 h 485

3 Strata coffee tables

Top in fused glass bronzo, legs in black elm.
54 3/4"x35 1/2" h 11"
Top and leg in mat marble travertino classico.
Ø 18 1/2" h 19"

4 Shindo tappeto

Colore natural.
Dimensioni su misura 6000x4000

4 Shindo carpet

Colour natural.
Customized sizes 236 1/4"x157 1/2"

Orbis divano Orbis sofa

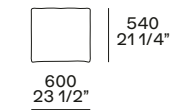
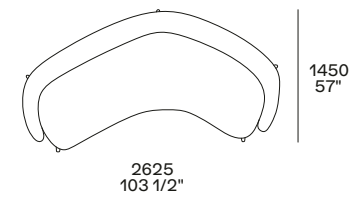

cuscino schienale
back cushion

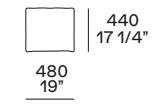

cuscino opzionale
optional cushion

Orbis poltrona Orbis armchair

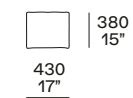
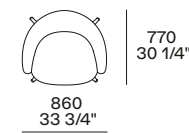

cuscino schienale
back cushion

Strata tavolini Strata coffee tables

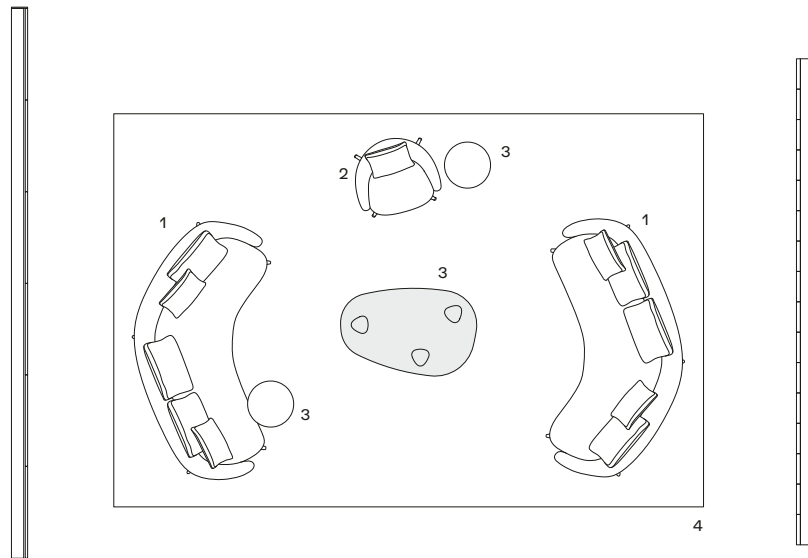
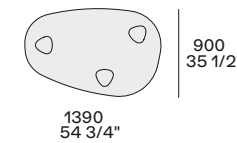

Display 25 mq-sqm

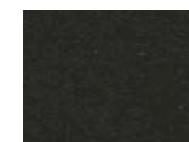

persia 1404 carbone
velluto - velvet

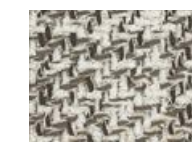

mizar 04 fango
tessuto - fabric



suede 02 corda
pelle - leather



dark sheer lucido
glossy dark sheer



vetrofusione fumé
fused glass fumé



olmo nero
black elm



travertino classico
marmo levigato
mat marble



tappeto Shindo natural
carpet Shindo natural



COMPOSITION 03

1 Orbis divano inclinato

Rivestimento in tessuto sfoderabile Altair 10 avio. Cuscini schienale in tessuto sfoderabile Altair 10 avio, cuscini opzionali in velluto sfoderabile Polar 10 avio. Piedini in metallo dark sheer opaco. I 2625 p 1450 h 690-835

Orbis angled sofa

Cover in removable fabric Altair 10 avio. Back cushions in removable fabric Altair 10 avio, optional cushions in removable velvet Polar 10 avio. Feet in mat metal dark sheer. w 103 1/2" d 57" h 27 1/4"-32 3/4"

2 Orbis poltrona

Rivestimento in tessuto sfoderabile Mintaka 02 sabbia. Cuscino schienale in velluto sfoderabile Persia 03 perla. Piedini in metallo dark sheer opaco. I 860 p 770 h 690

1 Orbis armchair

Cover in removable fabric Mintaka 02 sabbia. Back cushion in removable velvet Persia 03 perla. Feet in mat metal dark sheer. w 33 3/4" d 30 1/4" h 27 1/4"

3 Strata tavolini

Piano e gambe in marmo travertino classico levigato. Ø 1000 h 340 Ø 470 h 485 Piano in vetrofusione bronzo, gamba in olmo nero. Ø 470 h 485

2 Strata coffee tables

Top and legs in mat marble travertino classico. Ø 39 1/4" h 13 1/2" Ø 18 1/2" h 19" Top in fused glass bronzo, leg in black elm. Ø 18 1/2" h 19"

4 Shindo tappeto

Colore natural. Dimensioni su misura 5500x4500

3 Shindo carpet

Colour natural. Customized sizes 216 1/2"x177 1/4"

**Orbis divano
Orbis sofa**

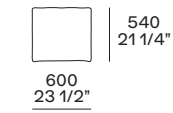
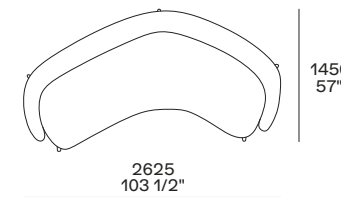

cuscino schienale
back cushion

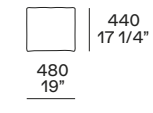

cuscino opzionale
optional cushion

**Orbis poltrona
Orbis armchair**

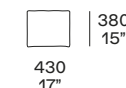
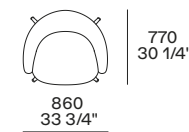

cuscino schienale
back cushion

**Strata tavolini
Strata coffee tables**

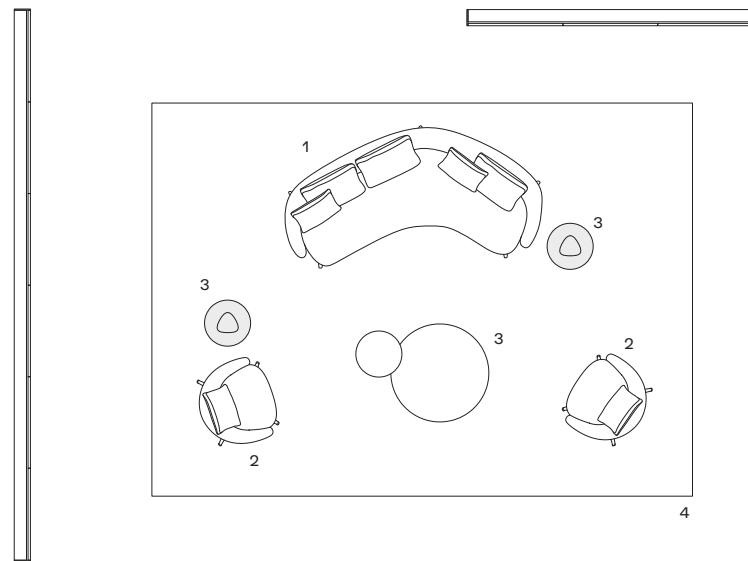
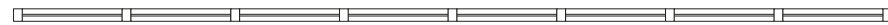
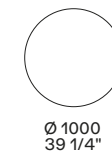

Display 25 mq-sqm

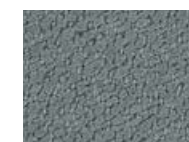

altair 10 avio
tessuto - fabric



polar 10 avio
velluto - velvet



mintaka 02 sabbia
tessuto - fabric

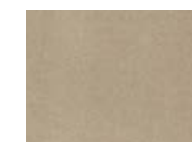

persia 03 perla
velluto - velvet



dark sheer opaco
mat dark sheer



travertino classico
marmo levigato
mat marble

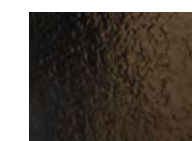

vetrofusione bronzo
fused glass bronzo

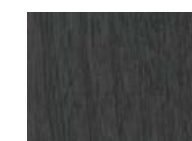

olmo nero
black elm



tappeto Shindo natural
carpet Shindo natural

FINITURE INDOOR
INDOOR FINISHINGS

Laccato opaco
Mat lacquer



82 glacier white 01 bianco 35 canapa 26 corda 88 castoro 46 tortora



64 arena 89 roccia 48 visone 49 moka 04 grafite 91 carbone



60 ghiaccio 09 pioggia 78 ferro 83 ocra 85 caramello liquirizia ●



92 vischio 87 granata 86 danubio 70 prussia 67 muschio



77 champagne 24 ottone 23 bronzo 90 piombo 02 ardesia basalto ●

Laccato lucido
Glossy lacquer



82 glacier white 01 bianco 35 canapa 26 corda 46 tortora 60 ghiaccio



48 visone 49 moka 83 ocra 85 caramello liquirizia ● 87 granata

● news

Essenza
Wood



rovere gold gold oak rovere spessart spessart oak noce c walnut c olmo nero black elm rovere bianco* white oak ●

* solo per struttura
interna made Duke
only for Duke
sideboard internal
structure

Essenza Print
Wood Print



rovere gold print gold oak print rovere spessart print spessart oak print noce c print walnut c print olmo nero print black elm print

Laccato antigraffio
Antiscratch lacquer



01 bianco 35 canapa 04 grafite 91 carbone

Laccato metallico
Metallic lacquer



23 bronzo 24 ottone 25 titanio magnesio ●

FINITURE INDOOR
INDOOR FINISHINGS

**Cuoio
Hide**



**Tecnocover Grain
Grain tecnocover**

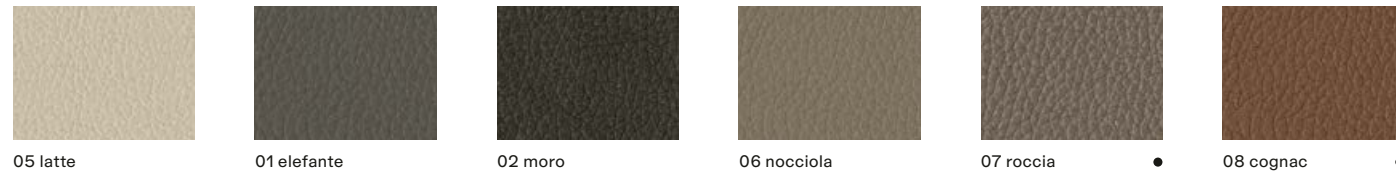

**Tessuto
Fabric**



**Inalco MDi®
Inalco MDi®**

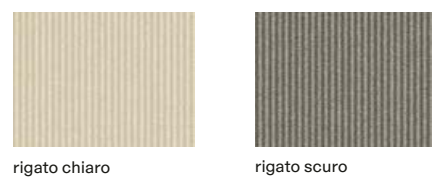

**Corda intrecciata
Braided rope**



**Marmo levigato
Mat marble**

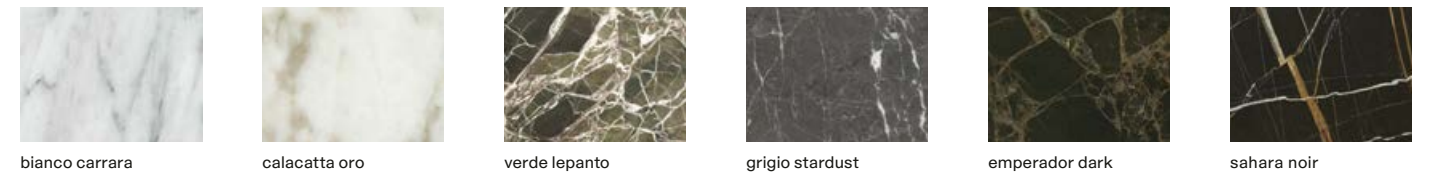

**Marmo lucido
Glossy marble**

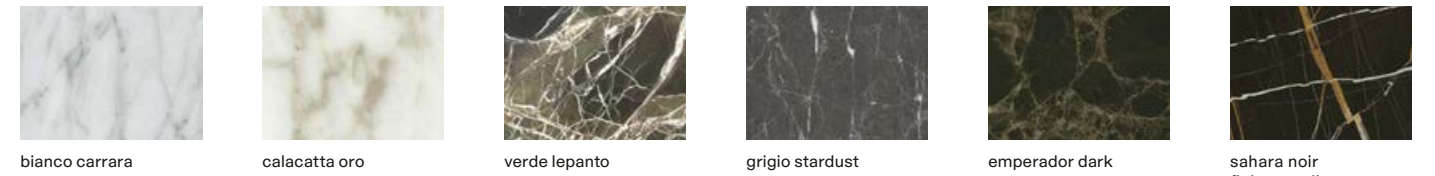

**Gabbro
Gabbro**



**Onice
Onyx**



**Semiprezioso
Semiprecious stone**



**Pietra spatolata
Spatula-finish stone**



**Grès porcellanato lucido
Glossy gres porcelain**



● news

FINITURE INDOOR
INDOOR FINISHINGS

Tessuti
Fabrics



chios cat. b
13 colori - colours



eraclea cat. b
12 colori - colours

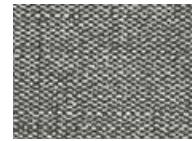

lima cat. c
11 colori - colours



antea cat. d
13 colori - colours



irati cat. d
11 colori - colours



itaca cat. d
10 colori - colours



brest cat. g
10 colori - colours



dundee cat. g
6 colori - colours



glasgow cat. g
6 colori - colours



hamal cat. g
4 colori - colours



lero cat. g
2 colori - colours



nancy cat. g
6 colori - colours



kiala cat. d
13 colori - colours



kushiro cat. d
13 colori - colours



micene cat. d
9 colori - colours



olimpia cat. d
14 colori - colours



rabat cat. d
10 colori - colours



sendai cat. d
5 colori - colours

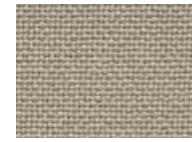

norwich cat. g
8 colori - colours



sheffield cat. g
9 colori - colours



siro cat. g
4 colori - colours



tebe cat. g
11 colori - colours



janaky cat. m
6 colori - colours



mintaka cat. m
3 colori - colours



sparta cat. d
12 colori - colours



yukon cat. d
20 colori - colours



agadir cat. e
9 colori - colours



altair cat. e
12 colori - colours



arcadia cat. e
12 colori - colours



argo cat. e
13 colori - colours



yushan cat. m
6 colori - colours



gibson cat. z
6 colori - colours



carson cat. e
10 colori - colours



fushui cat. e
10 colori - colours



kitami cat. e
12 colori - colours



komi cat. e
11 colori - colours



mizar cat. e
9 colori - colours

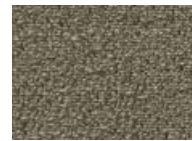

molai cat. e
7 colori - colours

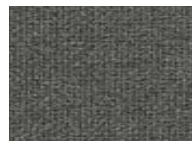

naxos cat. e
11 colori - colours



nayoro cat. e
10 colori - colours



orleans cat. e
10 colori - colours



persia cat. e
16 colori - colours



polar cat. e
14 colori - colours

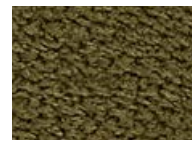

shedir cat. e
6 colori - colours



skyros cat. e
12 colori - colours

● news

FINITURE INDOOR
INDOOR FINISHINGS

**Pelle
Leather**



spring cat. p
13 colori - colours



colors cat. s
25 colori - colours

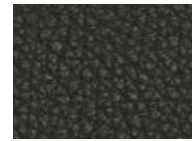

silk cat. s
13 colori - colours



silk intrecciata cat. s
woven leather silk
13 colori - colours

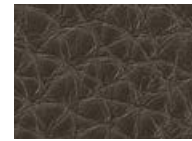

deep cat. x
10 colori - colours



special cat. x
21 colori - colours



suede cat. x
7 colori - colours

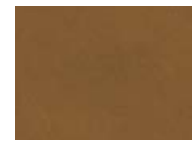

nabuk cat. y
10 colori - colours



nabuk intrecciata cat. y
woven leather nabuk
10 colori - colours



natural cat. y
10 colori - colours



soft cat. y
14 colori - colours

**Pelliccia Cashmere
Cashmere fur**



bianco



grigio



nero

**Pelle Hairy
Hairy leather**



bianco/nero



cappuccino



nero

**Tecnocover Pixel
Pixel tecnocover**

**Bordura gros-grain - filati
Grosgrain border - yarns**



burro



perla



nuvola



cenere



sahara



terra



oliva

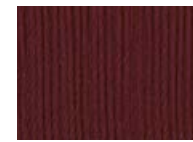

amaranto

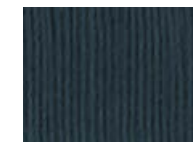

tempesta

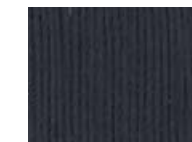

navy

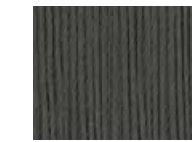

acciaio



nero

**Provence coordinati letto
Bed linen Provence**

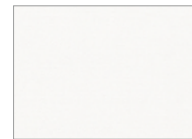

01 bianco



02 panna



08 polvere



04 tortora



06 roccia

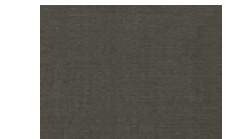

07 grafite



03 ghiaccio

FINITURE INDOOR
INDOOR FINISHINGS

**Vetro
Glass**



1000 trasparente
transparent



2000 trasparente
extrachiaro-transparent
extralight



3051 bronzato
bronzed



3050 fumé



2700 line



rain bianco



rain écru

**Vetro riflettente
Reflecting glass**

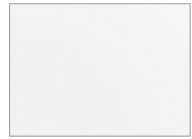

5000 trasparente
transparent



5010 blu



5051 bronzato
bronzed



5059 fumé

**Vetro acidato
Etched glass**



5380 acciaio



5323 bronzo

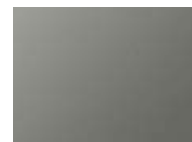

5325 titanio

**Vetro stratificato
Stratified glass**



2C01 lino carbone
linen carbone

**Vetrofusione
Fused glass**



bronzato
bronze



fumé
fumé

● news

**Vetro satinato
Mat glass**

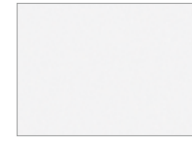

2301 bianco extrachiaro
extralight bianco

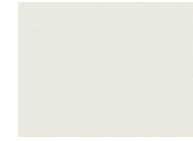

2373 ghiaccio
ghiaccio



1335 canapa



1364 arena



1304 grafite



1303 nero

**Vetro lucido
Glossy glass**



2201 bianco extrachiaro
extralight bianco



2273 ghiaccio



1235 canapa



1264 arena



1204 grafite



1203 nero



1259 bordeaux

**Specchio
Mirror**

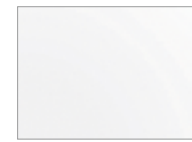

4000 bianco
white



4051 bronzato
bronzed

FINITURE INDOOR
INDOOR FINISHINGS

**Nobilitato
Melamine**



olmo
elm



noce blond
blond walnut



noce brown
brown walnut



noce c
walnut c



rovere tabacco
tabacco oak



rovere spessart
spessart oak



rovere cenere
cenere oak



canvas beige



canvas grigio



silk canapa



silk grey



silk bronzo



club 01 bianco



skin
27 colori laccato opaco
27 mat lacquered colours



skin 94 latte
laccato opaco
mat lacquered



skin 97 elefante
laccato opaco
mat lacquered



skin 93 moro
laccato opaco
mat lacquered



skin 98 nocciola
laccato opaco
mat lacquered



basalto

**Nobilitato interno cassetti
Melamine drawers structure**



basalto

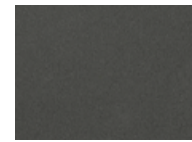

ardesia



madras
Quid sistema giorno -
day system

**Metacrilato
Methacrylate**



roller latte



roller ardesia

**Parti metalliche
Metal parts**



brown nickel opaco
mat brown nickel



brown nickel lucido
glossy brown nickel



brown nickel satinato
brushed brown nickel



champagne opaco
mat champagne



champagne satinato
brushed champagne

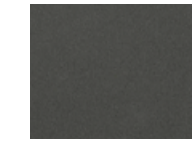

ardesia opaco
mat ardesia



cromo satinato
brushed chrome



cromo nero
black chrome



cromo nero satinato
brushed black chrome



bronzato
bronzed



bronzo anticato
antique bronze



brunito opaco
mat brunito



spatolato ferro
spatula-finish ferro



spatolato bronzo
spatula-finish bronzo



oro lucido
glossy gold



alluminio brill
aluminium brill



light sheer opaco
mat light sheer



light sheer lucido
glossy light sheer



dark sheer opaco
mat dark sheer



dark sheer lucido
glossy dark sheer

Poliform Spa

via Montesanto 28
Casella postale n. 1
22044 Inverigo (CO) Italy
t +39 031 6951
info@poliform.it
poliform.it



2018 Adi Compasso D'oro
Career Award

Poliform realizza tutte le sue collezioni in Italia usando componenti e materie prime selezionate.

All the Poliform collections are manufactured 100% in Italy using top-class components and materials.

Poliform si riserva il diritto di apportare, senza preavviso, ogni modifica mirata al miglioramento funzionale e qualitativo dei propri prodotti. Testi e disegni presenti in questo stampato hanno scopo divulgativo: per ogni aspetto tecnico e dimensionale fare riferimento ai listini aziendali e relativi aggiornamenti. I campioni di colori e materiali hanno valore indicativo.

Poliform reserves the rights at all time to apply modifications for the functional or qualitative improvement of its products. Texts and drawings present in this brochure have a divulgative purpose: for every technical and dimensional aspect please refer to the company's price lists and their relative updatings. The colour and material samples have an indicative value.

Graphic Design

Apartamento Studios

Interiors Photography

F2 Fotografia

Still Life Photography

Silvia Orlandi

Project and Interiors Styling

Poliform Lab

1st edition July 2024
cod. 137/R1/2024



TWO THOUSAND TWENTY FOUR