

SOFAS VOLUME TWO  
2022

**Poliform**





**Poliform**

Per completare divani e poltrone, Poliform propone i complementi: tavolini dai volumi contemporanei, pouf eleganti e versatili, tappeti fatti a mano con materiali di pregio. Complementi nel significato più pieno del termine, oggetti che completano l'arredamento di ogni ambiente con stile ed eleganza: Poliform fin nei dettagli.

To complete sofas and armchairs, Poliform offers the complements: coffee tables with contemporary volumes, elegant and versatile poufs, hand-made rugs with quality materials. Complements in the truest meaning of the term, objects that complete the furniture of each environment with style and elegance: Poliform down to the details.

COLLECTIONS

TAVOLINI  
COFFEE TABLES

7

POUF  
POUFS

193

TAPPETI  
CARPETS

249

# COFFEE TABLES

Una collezione di proposte diverse per estetica e materiali. Classici o contemporanei, caratterizzati da forme organiche o geometriche, imponenti o compatti, realizzati in finiture laccate, essenza o metallo e impreziositi da piani in cuoio, marmo, onice e lapislazzuli. I tavolini Poliform sono delle micro-architetture che si adattano alle diverse zone della casa, accanto al divano in salotto o come comodini nella zona notte.

A collection of different offers in style and materials. Classic or contemporary, characterized by organic or geometric shapes, large or compact, made in lacquered finishes, wood, or metal, and embellished by tops in leather, marble, onyx, and lapis lazuli. Poliform coffee tables are micro-architectures that adapt to the different areas of the house, next to the sofa in the living room or as bedside tables in the night area.

## COFFEE TABLES

KOISHI	11
MONDRIAN	27
WESTSIDE	43
CREEK	59
BRISTOL SYSTEM	73
TRIBECA	83
HOME HOTEL	93
HENRY	105
ORBIT	115
NARA	125
SOORI	135
ILDA	145
DAMA	155
BABA	165
FLUTE	175
PARIS SEOUL	185

# KOISHI



Pensati come naturale complemento del sistema Saint-Germain per le forme organiche e la pacata eleganza, i tavolini Koishi accompagnano con personalità tutti i divani e le poltrone della collezione. La struttura in metallo, scultorea ma essenziale, sostiene il top prezioso in pietra ebano, marmo, vetro riflettente o essenza.

Designed as natural complements to the Saint-Germain system for their organic shapes and quiet elegance, the Koishi coffee tables accompany with personality all the sofas and armchairs in the collection. The sculptural yet minimalist metal structure supports the precious top in ebony stone, marble, reflective glass, or wood.







Qui e nella pagina precedente: tavolini Koishi, al centro con piano in marmo sahara noir levigato finitura poliестere, accanto al divano con piano in marmo zecevo levigato, tutti con struttura brunito opaco. Divano Saint-Germain in tessuto sfoderabile Siro 01 bianco, cuscini in tessuto Brest 11 cioccolato, velluto Persia 2002 bruciato e velluto Glasgow 01 crema, piedini brown nickel opaco. Tavolini Orbit con piano e struttura in vetro bronzato. Poltrone Le Club in pelle non sfoderabile Silk 06 roccia. Contenitori Code con vani a giorno in laccato opaco bronzo, cassetti e fianchi in laccato opaco visone, top retroilluminato in laccato opaco bronzo e zoccolino in ardesia opaco. Tappeto Cannelé.

This and previous page: Koishi coffee tables, in the center with top in mat marble sahara noir polyester finish, next to the sofa with top in mat marble zecevo, all with mat brunito structure. Saint-Germain sofa in removable fabric Siro 01 bianco, cushions in fabric Brest 11 cioccolato, velvet Persia 2002 bruciato and velvet Glasgow 01 crema, mat brown nickel feet. Orbit coffee tables with top and structure in bronzed glass. Le Club armchairs in non-removable leather Silk 06 roccia. Code open storage units in mat lacquer bronzo, drawers and sides in mat lacquer visone, backlit top in mat lacquer bronzo and mat ardesia plinth. Carpet Cannelé.





In questa pagina: tavolino Koishi con piano in marmo zecevo levigato e struttura champagne opaco. Nella pagina successiva: tavolini Koishi, versione grande con piano in marmo sahara noir levigato finitura poliestere, versione piccola con piano in pietra ebano spatolata, entrambi con struttura brunito opaco.

This page: Koishi coffee table with top in mat marble zecevo and mat champagne structure. Next page: Koishi coffee tables, big version with top in mat marble sahara noir polyester finish, small version with top in ebony stone with spatula finish, both with structure mat brunito.



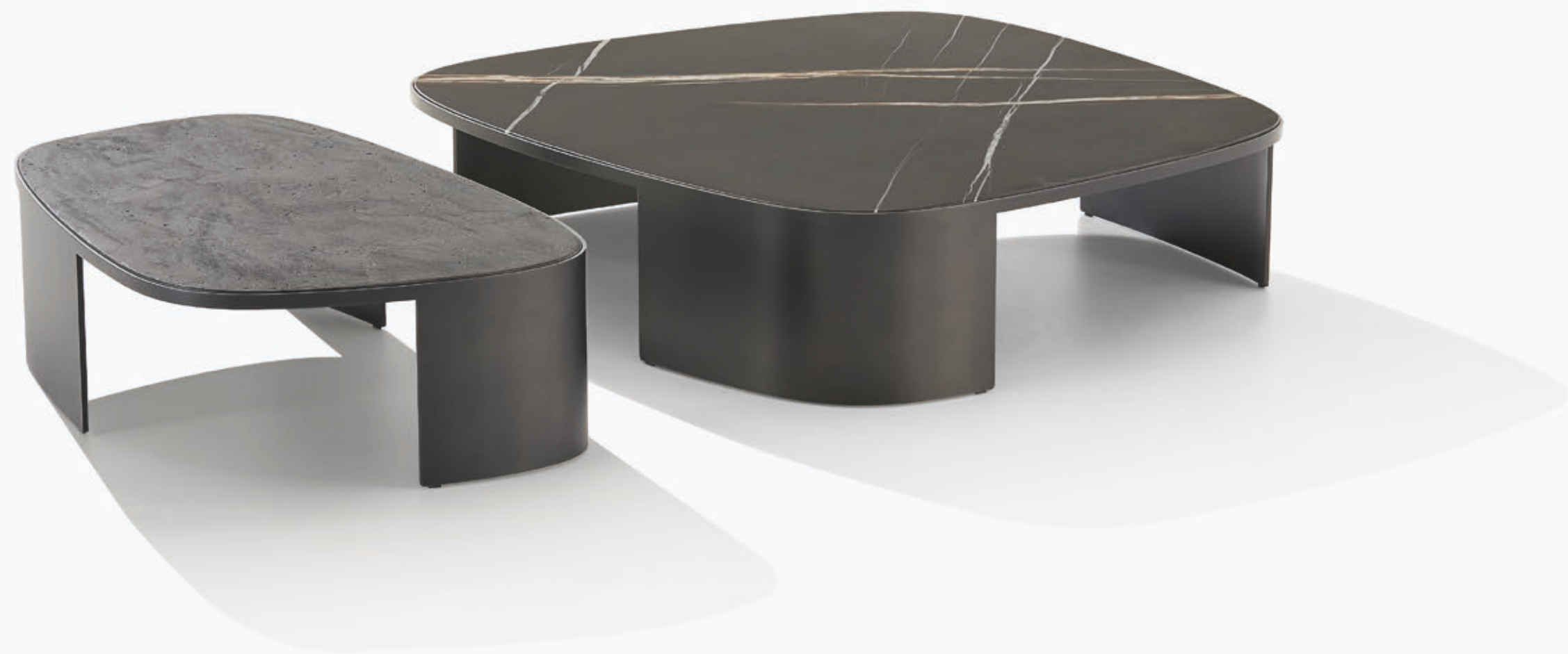

In questa pagina: tavolini Koishi, piano in vetro blu riflettente e struttura champagne opaco, piano in marmo zecevo levigato e struttura brunito opaco.

This page: Koishi coffee tables, top in blu reflecting glass and mat champagne structure, top in mat marble zecevo and mat brunito structure.

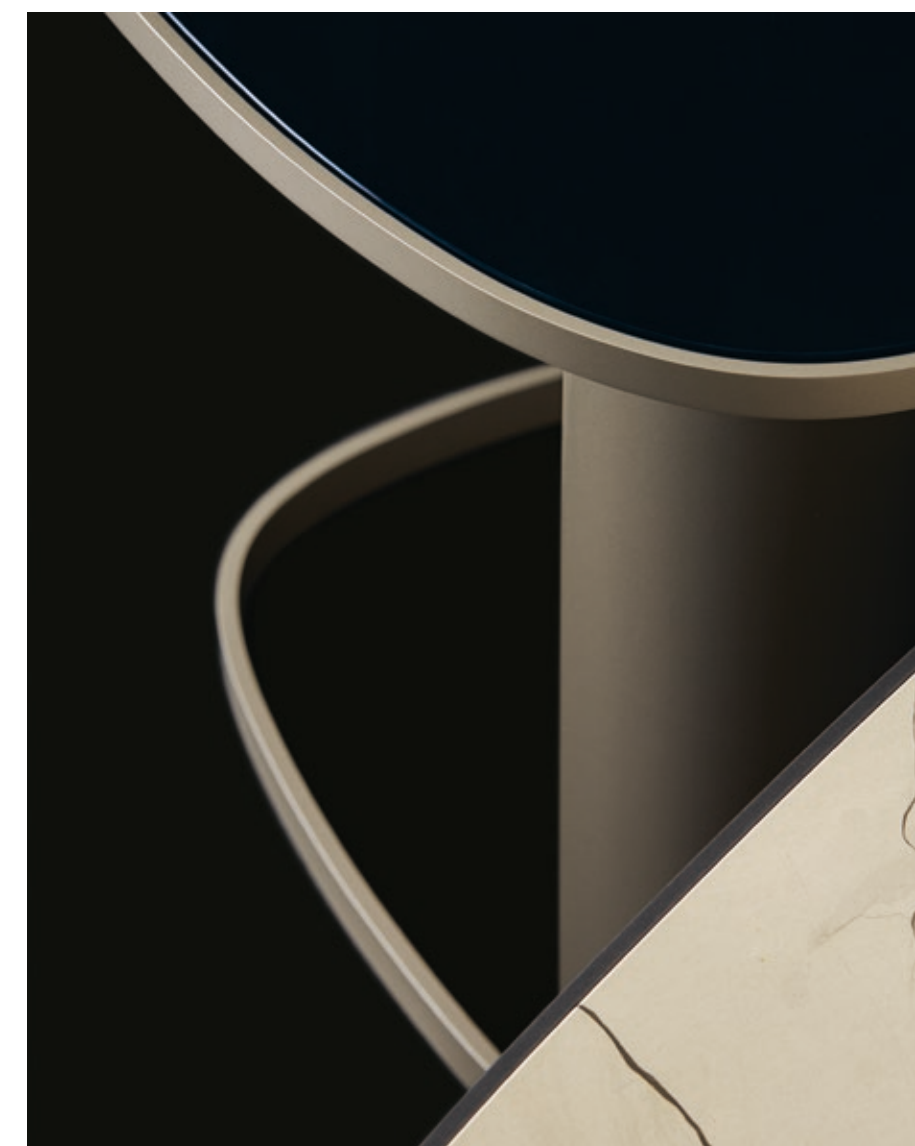



In questa pagina: tavolino Koishi con piano in marmo zecevo levigato e struttura brunito opaco. Divano Saint-Germain in tessuto sfoderabile Brest 02 salvia, cuscini in velluto Tebe 07 oliva, piedini brown nickel opaco. Pouf New York in velluto sfoderabile Persia 1404 carbone con piedini brown nickel lucido. Nella successiva: tavolini Koishi con piano in marmo zecevo levigato e struttura champagne opaco. Divano Saint-Germain in tessuto sfoderabile Agadir 03 pepe, cuscini in tessuto Nancy 100 cenere e velluto Persia 1404 carbone, piedini brown nickel opaco. Poltrone Le Club in pelle non sfoderabile Silk 01 crema. Boiserie Code in tessuto lino écreu con profili in champagne opaco. Libreria Lexington in rovere gold e champagne opaco. Tappeto Relief cammello.

This page: Koishi coffee table with top in mat marble zecevo and mat brunito structure. Saint-Germain sofa in removable fabric Brest 02 salvia, cushions in velvet Tebe 07 oliva and mat brown nickel feet. New York pouf in removable velvet Persia 1404 carbone with mat brown nickel feet. Next page: Koishi coffee tables with top in mat marble zecevo and mat champagne structure. Saint-Germain sofa in removable fabric Agadir 03 pepe, cushions in fabric Nancy 100 ruggine and velvet Persia 1404 carbone, mat brown nickel feet. Le Club armchairs in non-removable leather Silk 01 crema. Code wall panelling in fabric lino ecru with mat champagne profiles. Lexington bookcase in gold oak and mat champagne. Carpet Relief cammello.







## KOISHI

Design Jean-Marie Massaud, 2020

Struttura in metallo verniciato brunito opaco o champagne opaco.

Piano in olmo nero, rovere gold, vetro blu riflettente, pietra ebano spatolata o marmo levigato e lucido (escluso emperador dark).

Structure in metal painted mat brunito or mat champagne.

Top in black elm, gold oak, blu reflecting glass, ebony stone with spatula finish or mat and glossy marble (except emperador dark).

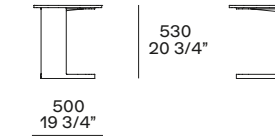
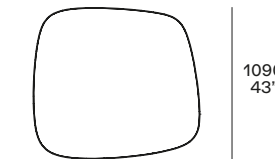
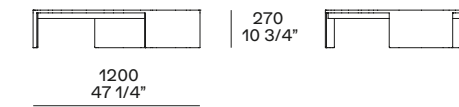
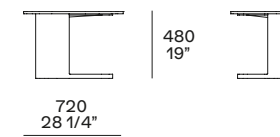
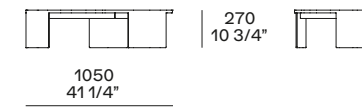

# MONDRIAN





Una collezione dall'immagine elegante e leggera, con sottili piani d'appoggio realizzati in essenza, marmo o nelle finiture laccato lucido e opaco. Disponibili in due altezze e di diverse forme per favorire la combinazione tra più elementi, questi tavolini sono facili da inserire nella zona living e perfetti in abbinamento all'omonimo sistema di divani.

A collection with an elegant and light image, with thin tops made of wood, marble, or glossy and mat lacquered finishes. Available in two heights and different shapes to facilitate the combination of several elements, these tables are easy to include in the living area and perfect in combination with the sofa system of the same name.





Nella pagina precedente: tavolini Mondrian con struttura in fusione di bronzo lucidata oro, piani in olmo nero e marmo calacatta oro levigato. Divano Mondrian in pelle sfoderabile Soft 10 prugna. In questa pagina: tavolini Mondrian con struttura in fusione di bronzo lucidata oro, piani in marmo noir saint laurent lucido e laccato lucido caramello. Divano Mondrian in tessuto sfoderabile Olimpia 11 polvere. Pouf Onda in pelle non sfoderabile Soft 04 cognac. Tappeto Frame grey.

Previous page: Mondrian coffee tables with structure in gold polished bronze casting, top in black elm and mat marble calacatta oro. Mondrian sofa in removable leather Soft 10 prugna. This page: Mondrian coffee tables with structure in gold polished bronze casting, top in glossy marble noir saint laurent and caramello glossy lacquer. Mondrian sofa in removable fabric Olimpia 11 polvere. Onda pouf in non-removable leather Soft 04 cognac. Carpet Frame grey.





In questa pagina: tavolino Mondrian con struttura in fusione di alluminio verniciato champagne opaco e piano in noce gold. Nella successiva: consolle Mondrian con struttura in fusione di alluminio verniciato brown nickel opaco e piano in olmo nero. Tavolini Mondrian rotondi con struttura in fusione di alluminio verniciato brown nickel opaco e piani in laccato opaco muschio e olmo nero; rotondo piccolo con struttura in fusione di bronzo lucidata oro e piano in marmo noir saint laurent lucido; quadrato con struttura in fusione di alluminio verniciato brown nickel lucido e piano in marmo bianco carrara levigato.

This page: Mondrian coffee table with structure in mat champagne painted aluminium casting and top in gold walnut. Next page: Mondrian console with structure in mat brown nickel painted aluminium casting and top in black elm. Mondrian round coffee tables with structure in mat brown nickel painted aluminium casting, muschio mat lacquered and black elm tops; round small version with structure in gold polished bronze casting and top in glossy marble noir saint laurent; square version with structure in glossy brown nickel painted aluminium casting and top in mat marble bianco carrara.







In questa pagina: tavolino Mondrian con struttura in fusione di alluminio verniciato brown nickel opaco e piano in marmo sahara noir lucido finitura poliester.

This page: Mondrian coffee table with structure in mat brown nickel painted aluminium casting and top in glossy marble sahara noir with polyester finish.

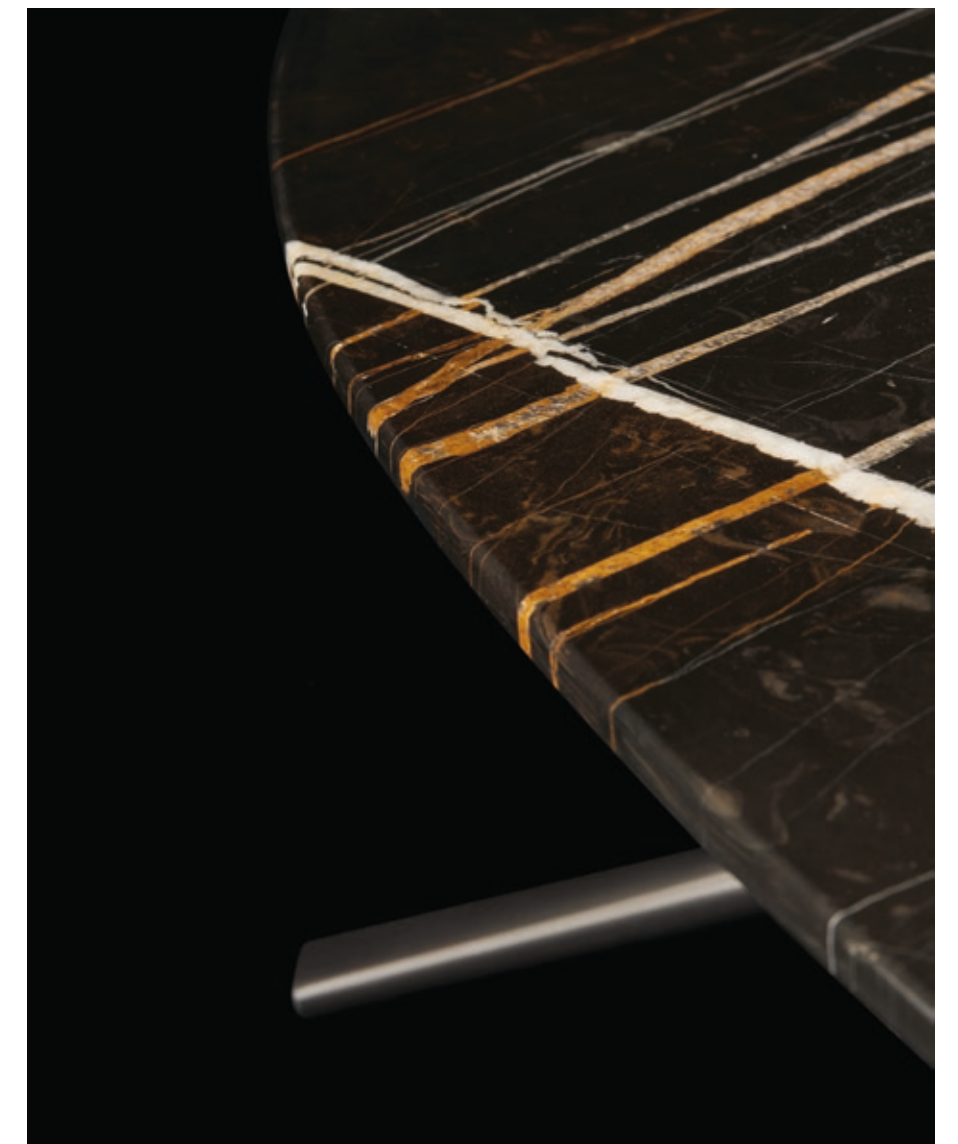



In questa pagina: tavolini e consolle Mondrian con struttura in fusione di bronzo lucidata oro e piani in marmo noir saint laurent lucido e laccato lucido visone. Divano Mondrian in tessuto sfoderabile Sparta 18 panna. Pouf Play in pelle intrecciata non sfoderabile Nabuk 02 tortora. Tappeto Soft. Nella pagina successiva: tavolini Mondrian con struttura in brown nickel lucido e piani in olmo nero e laccato lucido ocra; con struttura in fusione di bronzo lucidata oro e piano in marmo calacatta oro levigato. Divano Mondrian in pelle sfoderabile Soft 10 prugna. Poltrone Marlon Lounge in tessuto sfoderabile Sparta 16 ferro, gambe in olmo nero.

This page: coffee tables and console Mondrian with structure in gold polished bronze casting and top in glossy marble noir saint laurent and glossy lacquered visone. Mondrian sofa in removable fabric Sparta 18 panna. Carpet Soft. Next page: Mondrian coffee tables with structure in glossy brown nickel and tops in black elm and in ocra glossy lacquer; with structure in gold polished bronze casting and top in mat marble calacatta oro. Mondrian sofa in removable leather Soft 10 prugna. Marlon Lounge armchairs in removable fabric Sparta 16 ferro, legs in black elm.







## MONDRIAN

Design Jean-Marie Massaud, 2016

Struttura in fusione di bronzo lucidata oro o in fusione di alluminio verniciato brown nickel opaco e lucido o champagne opaco. Piano in laccato opaco colori, laccato lucido colori, olmo nero, noce gold, rovere spessart o marmo levigato e lucido.

Structure in gold polished bronze casting or in mat and glossy brown nickel or mat champagne painted aluminium casting. Top in mat lacquered colours, glossy lacquered colours, black elm, gold walnut, spessart oak or mat and glossy marble.

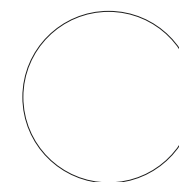
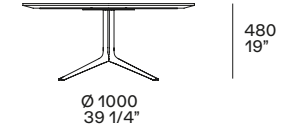
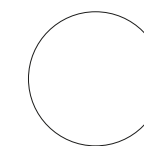
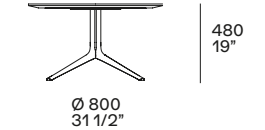
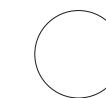
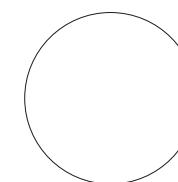
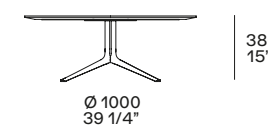
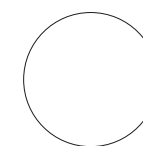
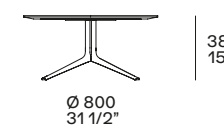
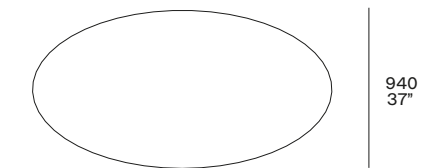
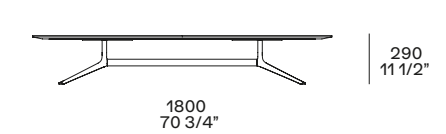
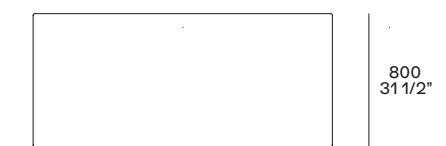
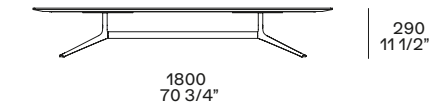
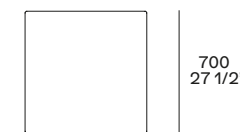
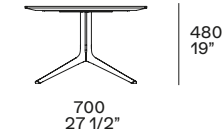
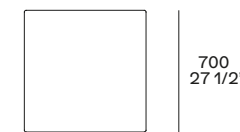
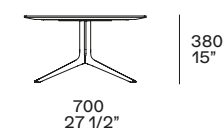
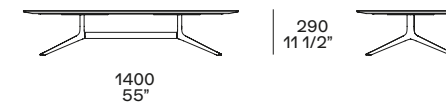

consolle h 480 / console h 19"

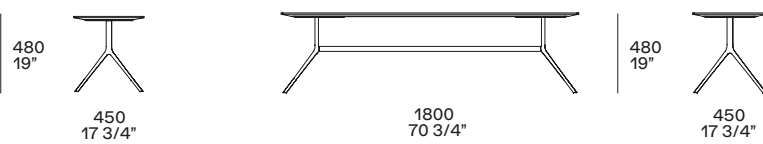
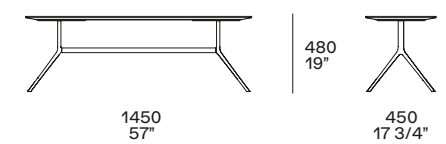



# WESTSIDE



Un raffinato equilibrio tra materiali e forme contraddistingue i tavolini della collezione Westside, che completano l'omonimo sistema di divani. Tre le versioni, disponibili in diverse finiture: il tavolino con cassetto o vano a giorno, il tavolino con base a incrocio in metallo e quello da accostare al divano.

A refined balance between materials and shapes characterizes the coffee tables of the Westside collection, which complete the homonymous system of sofas. There are three versions, available in different finishes: the coffee table with drawer or open compartment, the coffee table with crossed metal base, and the one to place next to the sofa.







Nella pagina precedente: tavolini Westside, quadrato con piano superiore in marmo zecevo levigato e rettangolare con piano superiore in olmo nero, strutture in olmo nero. Divano Westside in tessuto sfoderabile Arcadia 02 sabbia, cuscini in velluto Tebe 06 giada, basamento brown nickel opaco. Poltrona Kay Lounge in pelle non sfoderabile Hairy bianco/nero e struttura in cromo satinato. Madia Code in noce gold con top in laccato metallico bronzo e vano a giorno in laccato opaco bronzo. Tappeto Tratto carbone. A sinistra: tavolino Westside con piano in marmo zecevo levigato e struttura in brown nickel opaco. Sotto: dettaglio del tavolino Westside rettangolare con piano superiore e struttura in olmo nero.

Previous page: Westside coffee tables, square with top in mat marble zecevo and rectangular with top in black elm, structures in black elm. Westside sofa in removable fabric Arcadia 02 sabbia, cushions in velvet Tebe 06 giada, mat brown nickel base. Kay Lounge armchair in non-removable Hairy leather white/black and structure in brushed chrome. Code sideboard in gold walnut with top in metal lacquer bronzo and open compartment in mat lacquer bronzo. Carpet Tratto carbone. Left: Westside coffee table with top in mat marble zecevo and structure in mat brown nickel. Below: close up of the rectangular Westside coffee table with top and structure in black elm.





In questa pagina: tavolino Westside con piano in marmo sahara noir lucido finitura poliester e struttura in champagne opaco. Nella successiva: tavolino Westside con piano e struttura in olmo nero, attrezzato con cassetto in laccato metallico bronzo. Tavolini con struttura in metallo finitura in brown nickel opaco con piano in olmo nero, in champagne opaco con piano in marmo sahara noir lucido finitura poliester.

This page: Westside coffee table with top in glossy marble sahara noir with polyester finish and structure in mat champagne. Next page: Westside coffee table with top and structure in black elm, accessorized with drawer in metal lacquer bronzo. Coffee tables with structure in metal in mat brown nickel finish with black elm top, in mat champagne opaco con piano in marmo sahara noir lucido finitura poliester.





In questa pagina: tavolino Westside rettangolare con piano superiore in marmo zecevo levigato e struttura in olmo nero.

This page: rectangular Westside coffee table with top in mat marble zecevo and black elm structure.





In questa pagina: tavolini Westside con piano superiore in marmo sahara noir opaco finitura poliester e in olmo nero, struttura in olmo nero. Divano Westside in tessuto sfoderabile Arcadia 05 bronzo, cuscini in tessuto Siro 04 notte, basamento in brown nickel opaco. Poltrona Kay Lounge in pelle non sfoderabile Silk 06 roccia e struttura in cromo satinato. Tavolino Nara in legno massello noce gold. Composizione Code con contenitori in olmo nero e laccato metallico ottone con top in marmo zecevo levigato, boiserie in tessuto lino chiaro e laccato opaco canapa. Tappeto Plain tortora. Nella successiva: tavolini Westside con piano superiore in marmo zecevo levigato e in olmo nero, struttura in olmo nero. Tappeto Tratto carbone.

This page: Westside coffee tables with top in mat marble sahara noir with polyester finish and in black elm, black elm structure. Westside sofa in removable fabric Arcadia 05 bronzo, cushions in fabric Siro 04 notte, base in mat brown nickel. Kay Lounge armchair in non-removable leather Silk 06 roccia and structure in brushed chrome. Nara coffee table in solid wood gold walnut. Code composition with storage units in black elm and metal lacquer ottone with top in mat marble zecevo levigato, boiserie in tessuto lino chiaro and mat lacquer canapa. Carpet Plain tortora. Next page: Westside coffee tables with top in mat marble zecevo and in black elm, structure in black elm. Carpet Tratto carbone.







## WESTSIDE

Design Jean-Marie Massaud, 2019

Tavolini con struttura e base in olmo nero. Piano superiore in olmo nero o marmo levigato e lucido. Per tavolino 1200x1200, solo con piano superiore in olmo nero, disponibile cassetto opzionale in laccato opaco colori, laccato lucido colori, laccato metallico nei colori ottone e bronzo. Tavolini con struttura in metallo verniciato brown nickel opaco o champagne opaco. Piano in olmo nero o marmo levigato e lucido.

Coffee tables with structure and base in black elm. Top in black elm or mat and glossy marble. For coffee table 47 1/4" x 47 1/4", only with top in black elm, an optional drawer is available in mat lacquered colours, glossy lacquered colours, metal lacquered in ottone and bronzo colours. Coffee tables with structure in metal painted mat brown nickel or mat champagne. Top in black elm or mat and glossy marble.

### Struttura e base essenza Wood structure and base

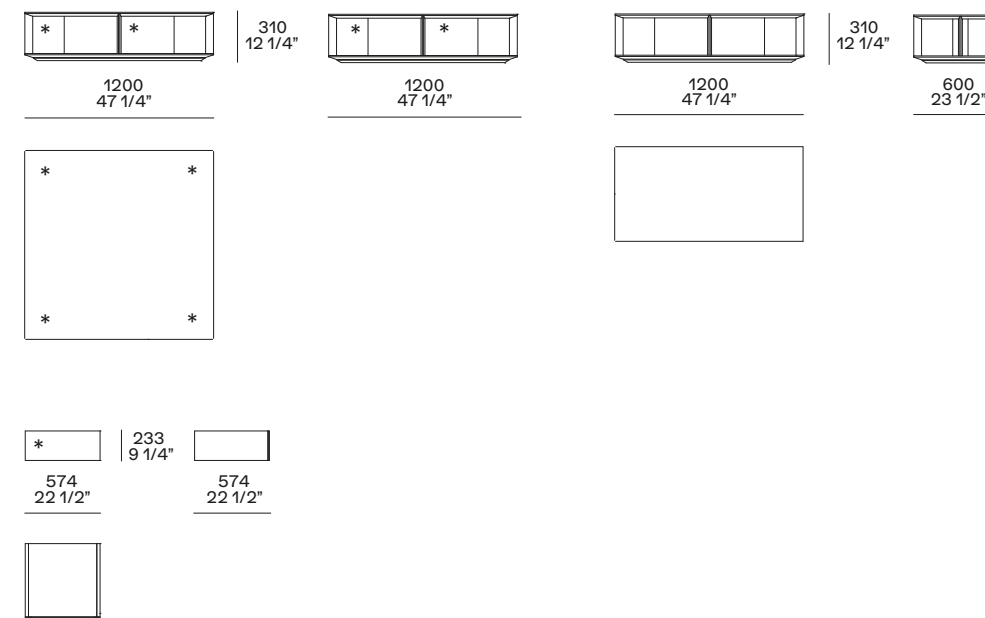

cassetto opzionale disponibile solo per tavolino 1200x1200 con piano superiore in olmo nero  
optional drawer available only for coffee table 47 1/4"x47 1/4" with top in black elm

### Struttura metallo Metal structure

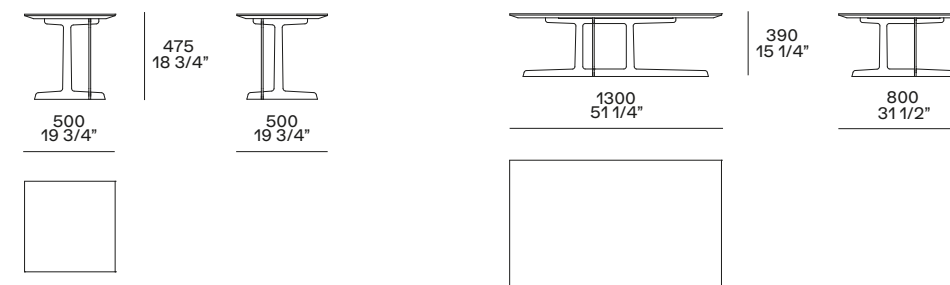

utilizzabile esclusivamente accostato ad un modulo del divano Westside o al tavolino 1300x800  
to be used only next to a module of the Westside sofa or to the coffee table 51 1/4"x31 1/2"

per accostamento ad un modulo del divano Westside necessario kit distanziale (per raggiungimento h tavolino 435)  
spacer kit (to reach coffee table height 17 1/4") needed for combination with a module of the Westside sofa



# CREEK



Creek è una collezione di tavolini di varie dimensioni, accomunati dal design composto da due vassoi sovrapposti appoggiati su una struttura di metallo. I colori e le finiture di ogni vassoio si possono abbinare a piacere, scegliendo tra colori laccati, legno, marmo e vetro per il vassoio superiore; colori laccati lucidi e opachi o legno per il vassoio inferiore.

Creek is a collection of coffee tables of various sizes, united by a design characterized by two trays on top of each other resting on a metal structure. The colours and finishes of each tray can be combined as desired, choosing between lacquered colours, wood, marble, and glass for the upper tray; glossy and mat lacquered colours or wood for the lower tray.





Qui e nella pagina precedente: tavolini Creek, quadrato con piano superiore in marmo sahara noir lucido finitura poliester, rettangolare con piano superiore in vetro fumé, piani inferiori in olmo nero e struttura brown nickel satinato. Tavolino Creek rotondo con piano superiore in nero assoluto texture juta, piano inferiore in olmo nero e struttura brown nickel satinato. Divano Bellport con rivestimento sfoderabile in pelle Nabuk 09 ruggine e piedini con profilo brown nickel opaco.

This and previous page: Creek coffee tables, square version with top in glossy marble sahara noir with polyester finish, rectangular version with top in fumé glass, lower shelves in black elm and structure in brushed brown nickel. Round coffee table Creek with top in nero assoluto texture juta, lower shelf in black elm and structure in brushed brown nickel. Bellport sofa with removable cover in leather Nabuk 09 ruggine and feet with profile mat brown nickel.





In questa pagina: tavolino Creek con piano superiore in vetro fumé, piano inferiore in olmo nero e struttura brown nickel satinato. Nella pagina successiva: tavolini Creek con piano superiore in marmo calacatta oro lucido, piano inferiore laccato lucido canapa e struttura champagne satinato.

This page: Creek coffee table with top shelf in fumé glass, lower shelf in black elm and brushed brown nickel structure. Next page: Creek coffee tables with top shelf in glossy marble calacatta oro, canapa glossy lacquered lower shelf and structure in brushed champagne.







In questa pagina: tavolino Creek con piano superiore in marmo sahara noir lucido finitura poliesteri, piano inferiore in olmo nero e struttura brown nickel satinato. Nella successiva: tavolini Creek, rettangolare e quadrato piani in marmo calacatta oro lucido e laccato lucido canapa, struttura champagne satinato; rotondi piani in vetro fumé e olmo nero, struttura in brown nickel satinato. Divani Bellport in tessuto sfoderabile Naxos 07 cemento, pouf Bellport in pelle sfoderabile Soft 13 carbone; divani e pouf con piedini champagne opaco. Composizione Wall System in rovere spessart e schienali in laccato lucido canapa. Tappeto Frame grey.

This page: Creek coffee table with top shelf in glossy marble sahara noir with polyester finish, lower shelf in black elm and brushed brown nickel structure. Next page: Creek coffee tables, rectangular and square version with top in glossy marble calacatta oro and canapa glossy lacquer, structure in brushed champagne; round version with top in glass fumé and black elm, structure in brushed brown nickel. Bellport sofas with removable cover in fabric Naxos 07 cemento, pouf Bellport with removable cover in leather Soft 13 carbone; sofas and pouf with feet in mat champagne. Wall System composition in spessart oak and backs in glossy lacquer canapa. Carpet Frame grey.

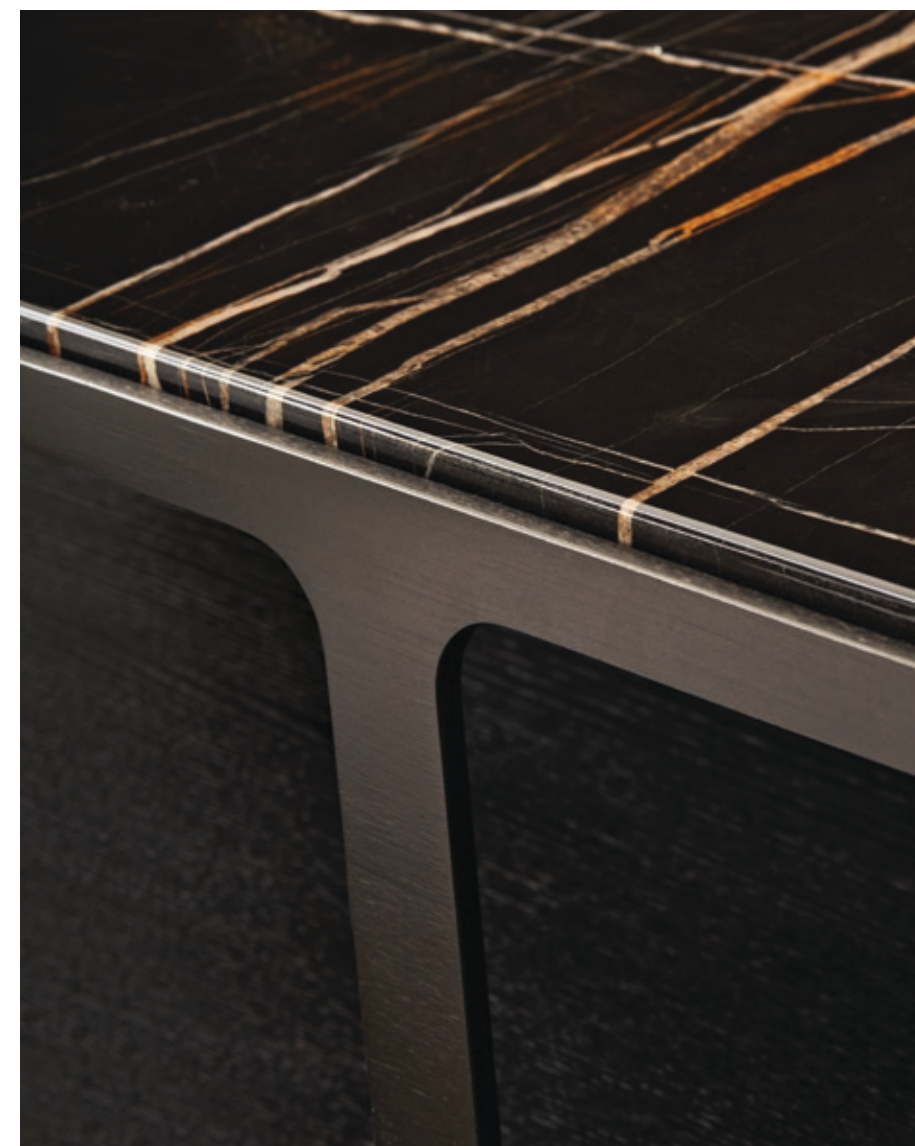



## CREEK

Design Jean-Marie Massaud, 2018

Struttura in metallo verniciato brown nickel satinato o champagne satinato.  
 Piano superiore in laccato opaco colori, laccato lucido colori, rovere spessart, olmo nero, noce gold, vetro fumé, marmo levigato e lucido o nero assoluto texture juta.  
 Piano inferiore in laccato opaco colori, laccato lucido colori, rovere spessart, olmo nero o noce gold.

Structure in brushed brown nickel or brushed champagne painted metal.  
 Top in mat lacquered colours, glossy lacquered colours, spessart oak, black elm, gold walnut, fumé glass, mat and glossy marble or nero assoluto texture juta.  
 Lower shelf in mat lacquered colours, glossy lacquered colours, spessart oak, black elm or gold walnut.

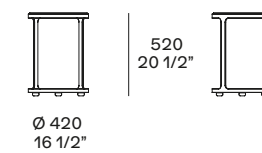
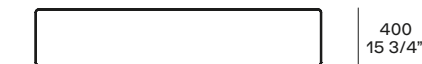
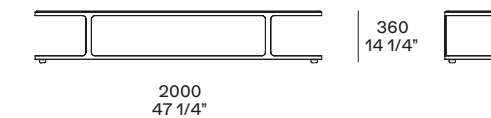
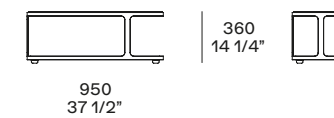
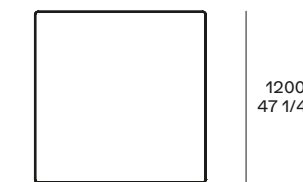
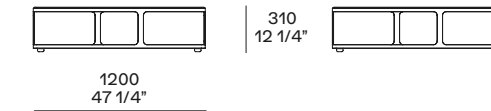
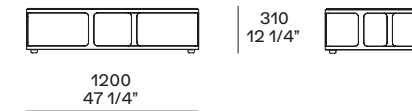





# BRISTOL SYSTEM



A completare la collezione Bristol, composta da divano, libreria e madia, ci sono anche i tavolini da centro stanza, caratterizzati da due piani sovrapposti. Sostegni in metallo intersecano il piano superiore, diventando la cifra stilistica dell'intera collezione. Il piano inferiore è disponibile in laccato opaco o in essenza, quello superiore anche in marmo.

To complete the Bristol collection, consisting of sofa, bookcase, and sideboard, there are also coffee tables for the center of the room, characterized by two planes on top of each other. Metal supports intersect the upper top, becoming the signature style of the entire collection. The lower shelf is available mat lacquered or in wood, the upper one also in marble.





Nella pagina precedente: tavolino Bristol con piano superiore in marmo calacatta oro levigato, piano inferiore in olmo nero, inserti e piedini in brown nickel opaco. Divano Bristol in tessuto sfoderabile Milos 05 cemento, cuscini velluto Persia 1404 carbone e tavolini retro divano Bristol in olmo nero. Tavolini Tribeca in brown nickel opaco con piani in olmo nero. Pouf Onda in pelle non sfoderabile Soft 04 cognac. Poltrone Mad Joker rivestimento non sfoderabile, esterno in pelle Nabuk 02 tortora e interno in tessuto Argo 1004 cenere, basamento girevole in brown nickel lucido. In questa pagina: tavolino Bristol con piano superiore in marmo noir saint laurent lucido, piano inferiore laccato opaco visone, inserti e piedini in brown nickel opaco.

Previous page: Bristol coffee table with top in mat marble calacatta oro, lower shelf in black elm, inlays and feet in mat brown nickel. Bristol sofa in removable fabric Milos 05 cemento, cushions in velvet Persia 1404 carbone and Bristol coffee tables to the back of the sofa in black elm. Tribeca coffee tables in mat brown nickel with top in black elm. Onda pouf in non-removable leather Soft 04 cognac. Mad Joker armchairs with non-removable cover, outer cover in leather Nabuk 02 tortora and inner cover in fabric Argo 1004 cenere, swivel base in glossy brown nickel. This page: Bristol coffee table with top in glossy marble noir saint laurent, visone mat lacquered lower shelf, inlays and feet in mat brown nickel.

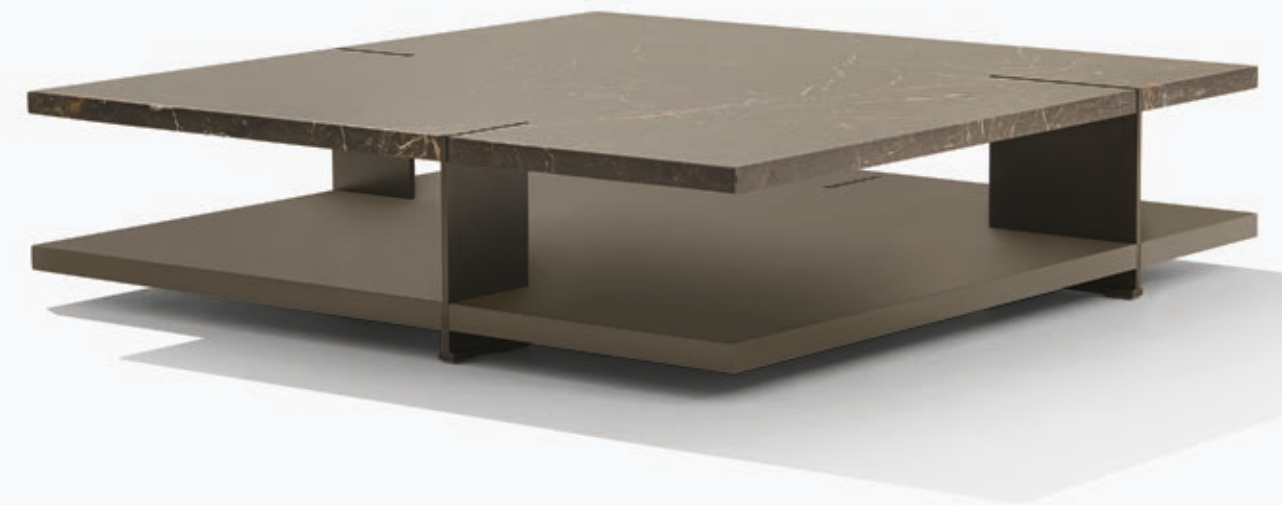

In questa pagina: tavolino Bristol con piani in olmo nero, inserti e piedini in brown nickel lucido. Nella pagina successiva: tavolino Bristol con piano superiore in marmo calacatta oro levigato, piano inferiore in olmo nero, inserti e piedini in brown nickel opaco. Divano Bristol in tessuto sfoderabile Milos 05 cemento. Pouf Onda in pelle non sfoderabile Soft 04 cognac.

This page: Bristol coffee table with top and lower shelf in black elm, inlays and feet in glossy brown nickel. Next page: Bristol coffee table with top in mat marble calacatta oro, lower shelf in black elm, inlays and feet in mat brown nickel. Bristol sofa in removable fabric Milos 05 cemento. Onda pouf in non-removable leather Soft 04 cognac.







## BRISTOL SYSTEM

Design Jean-Marie Massaud, 2015

Piani in laccato opaco colori, rovere spessart o olmo nero. Piano superiore disponibile anche in marmo levigato e lucido (escluso emperador dark e sahara noir).  
Inseriti e piedini in metallo verniciato brown nickel opaco o lucido.

Shelves in mat lacquered colours, spessart oak or black elm. Top shelf available also in mat and glossy marble (except emperador dark and sahara noir).  
Inlays and feet in mat or glossy brown nickel painted metal.

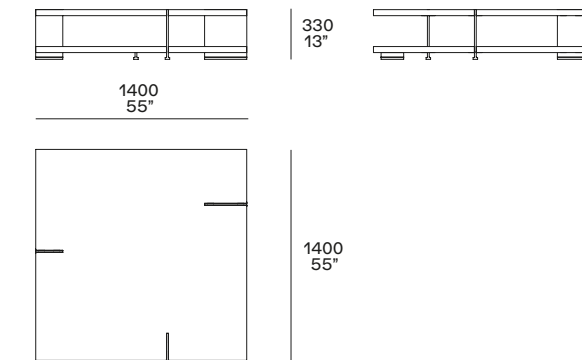
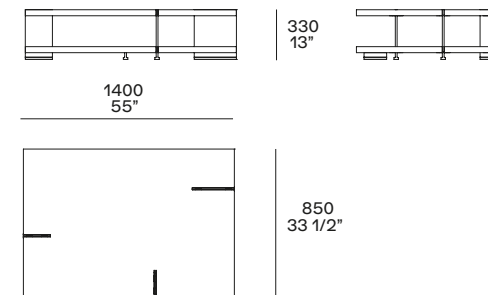



# TRIBECA



Una collezione di tavolini caratterizzata dalla base in metallo e dalla rigorosa geometria. I coffee table sono completati da piani in essenza o marmo, di dimensioni e forme diverse. L'insieme è di carattere e allo stesso tempo elegante, splendida unione per ambienti di classe.

A collection of coffee tables characterized by a metal base and rigorous geometry. The coffee tables are completed by tops in wood or marble, of different sizes and shapes. The whole set has character but is elegant at the same time, splendid combination for classy environments.





Nella pagina precedente: tavolino Tribeca con struttura in brown nickel opaco e piano in marmo calacatta oro lucido. Composizione Wall System in rovere spessart, griglie in laccato opaco ardesia, ribalta sporgente Jet nella versione bar. Poltrona Santa Monica Home in tessuto sfoderabile Naxos 27 prussia. Pouf Onda in velluto non sfoderabile Persia 1403 ocra. In questa pagina: tavolino Tribeca rettangolare con struttura in brown nickel opaco e piano in olmo nero, rotondo con struttura in brown nickel lucido e piano in marmo noir saint laurent lucido.

Previous page: Tribeca coffee table with structure in mat brown nickel and top in glossy marble calacatta oro. Wall System bookcase in spessart oak, grids in mat lacquer ardesia, jutting out flap door Jet in the version with bar accessories. Santa Monica Home armchair in removable fabric Naxos 27 prussia. Onda pouf in non-removable velvet Persia 1403 ocra. This page: Tribeca rectangular coffee table with structure in mat brown nickel and top in black elm, round version with structure in glossy brown nickel and top in glossy marble noir saint laurent.







In questa pagina: tavolino Tribeca con struttura in brown nickel opaco e piano in marmo emperador dark levigato. Nella pagina successiva: tavolini Tribeca con struttura in brown nickel opaco e piano in marmo emperador dark lucido. Composizione Wall System con struttura e inserti attrezzati in rovere spessart, ante Slim a ribalta laccato opaco visone. Divano Paris Seoul in tessuto sfoderabile Kitami 04 sabbia, cuscini in velluto Persia 2006 prugna.

This page: Tribeca coffee table with structure in mat brown nickel and top in mat marble emperador dark. Next page: Tribeca coffee tables with structure in mat brown nickel and top in glossy marble emperador dark. Wall System bookcase with structure and accessorized inserts in spessart oak, visone mat lacquer Slim flap doors. Paris Seoul sofa in removable fabric Kitami 04 sabbia, cushions in velvet Persia 2006 prugna.





## TRIBECA

Design Jean-Marie Massaud, 2012

Struttura in metallo verniciato brown nickel opaco o lucido.  
Piano in rovere spessart, olmo nero o in marmo levigato e lucido.

Structure in mat or glossy brown nickel painted metal. Top in spessart oak, black elm or in mat and glossy marble.

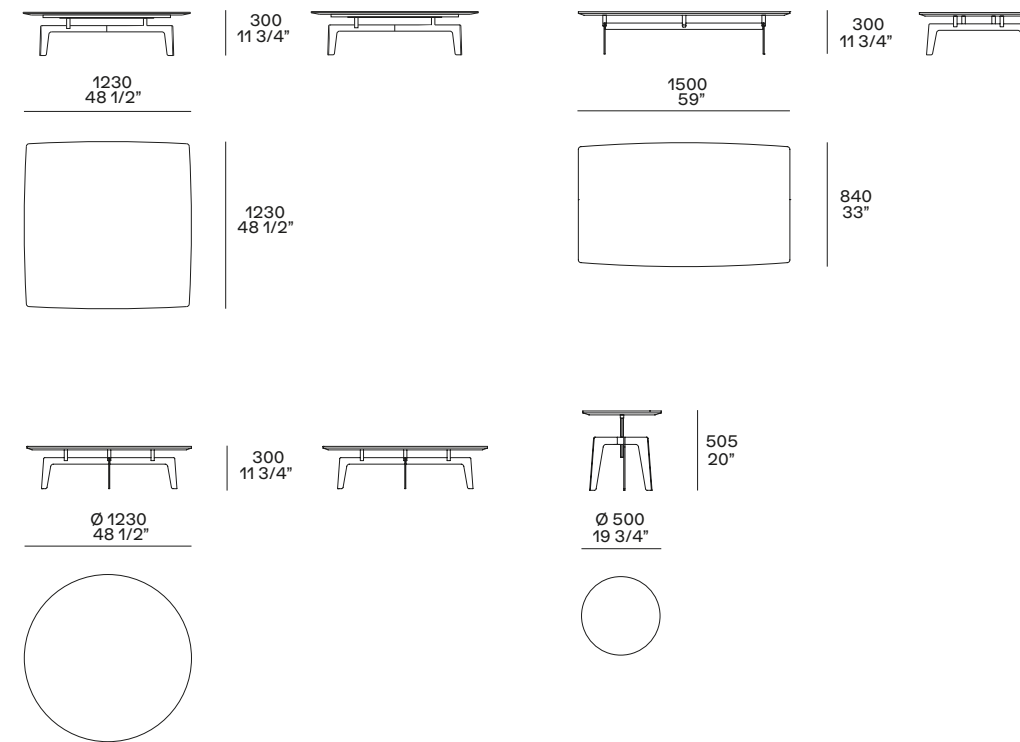





# HOME HOTEL



Il filo conduttore dei tavolini Home Hotel è la versatilità. Le due versioni, rettangolare e quadrata, sono accomunate dal piano in essenza, che acquista ritmo grazie al particolare gioco di listelli. Assieme a consolle e panche, i tavolini Home Hotel creano un vero e proprio sistema, in casa e nei luoghi dell'ospitalità.

The theme of the Home Hotel coffee tables is versatility. The two versions, rectangular and square, share a wooden top that acquires rhythm thanks to the particular play of strips. Together with the console tables and benches, the Home Hotel coffee tables create a true system, for the house and for accommodation facilities.







Nella pagina precedente: tavolino Home Hotel in olmo nero. Divano Bristol in tessuto sfoderabile Naxos 17 corda con cuscini Zante 10 nero. Poltrona Jane in velluto sfoderabile Persia 54 prussia e basamento in olmo nero. Tavolino Baba in metallo verniciato oro lucido e piano in vetro oro. Pouf Henry in olmo nero e seduta non sfoderabile in velluto Persia 1404 carbone. Tappeto Frame carbone. In questa pagina: tavolino Home Hotel in olmo nero. Divano Bristol in tessuto sfoderabile Kitami 02 cenere. Tavolino Dama laccato lucido visone. Poltrone Ipanema in olmo nero e pelle non sfoderabile Nabuk 01 latte.

Previous page: Home Hotel coffee table in black elm. Bristol sofa in removable fabric Naxos 17 corda with cushions Zante 10 nero. Jane armchair in removable velvet Persia 54 prussia and base in black elm. Baba coffee table in glossy gold painted metal and top in gold glass. Henry pouf in black elm and seat in non-removable velvet Persia 1404 carbone. Carpet Frame carbone. This page: Home Hotel coffee table in black elm. Bristol sofa in removable fabric Kitami 02 cenere. Visone glossy lacquered Dama coffee table. Ipanema armchairs in black elm and non-removable leather Nabuk 01 latte.





In questa pagina: tavolino Home Hotel con struttura e piano in olmo nero. Sotto: dettaglio della struttura e dei listelli che caratterizzano il piano della collezione tavolini e panche Home Hotel.

This page: Home Hotel coffee table with structure and top in black elm. Below: close up of the structure and of the wooden slats distinguishing the top of the coffee tables and benches collection Home Hotel.





In questa pagina: tavolino Home Hotel con struttura e piano in olmo nero. Nella pagina successiva: panca Home Hotel struttura e seduta a listelli in olmo nero. Armadi Senzafine Fitted in vetro fumé e telaio laccato opaco carbone e armadi Senzafine Ocean in vetro satinato nero con telaio laccato opaco carbone. Tappeto Dama.

This page: Home Hotel coffee table with structure and top in black elm. Next page: Home Hotel bench, structure and seat with slats in black elm. Wardrobes Senzafine Fitted in fumé glass with carbone mat lacquered frame and wardrobes Senzafine Ocean in mat glass nero with carbone mat lacquered frame. Carpet Dama.

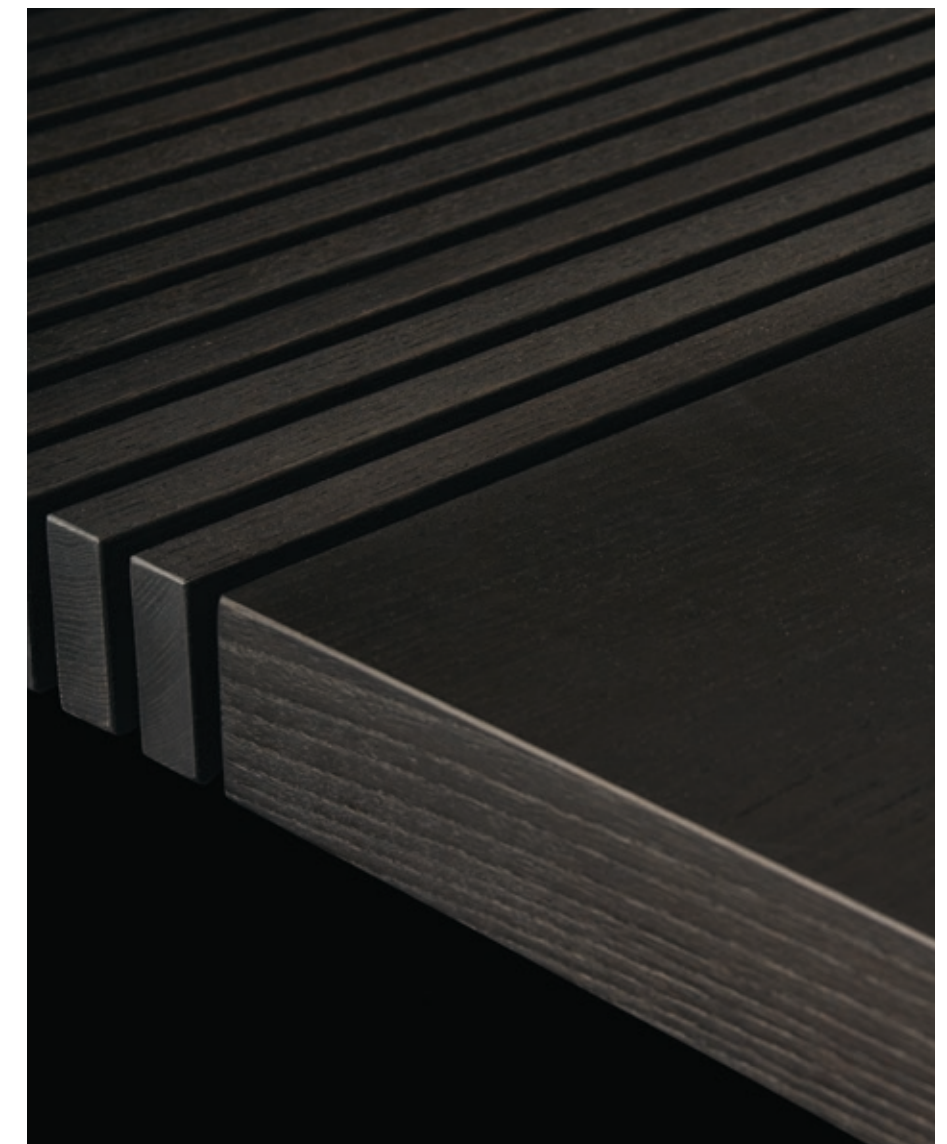



## HOME HOTEL

Design Jean-Marie Massaud, 2017

Struttura e listelli piano in massello,  
finitura olmo nero. Piano in olmo nero.

Structure and slats of the top in solid wood  
finish black elm. Top in black elm.

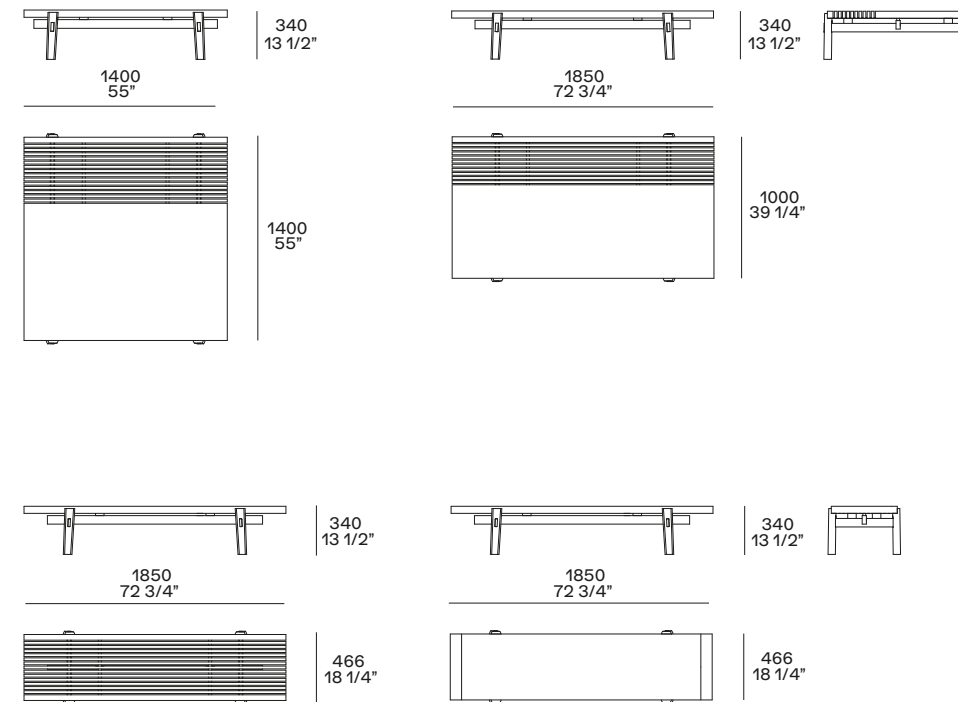



# HENRY

Emmanuel Gallina disegna una collezione di tavolini dall'estetica lineare, con piano in marmo o vetro e struttura in essenza. Disponibili di varie forme e dimensioni, possono essere usati singolarmente o in combinazione.

Emmanuel Gallina designs a collection of coffee tables with a linear look, with a marble or glass top and a wooden structure. Available in various shapes and sizes, they can be used individually or in combination.





Nella pagina precedente: tavolino Henry con struttura in olmo nero e piano in vetro lucido bordeaux. Divano Jane con rivestimento sfoderabile in tessuto Orleans 12 carbone e basamento in olmo nero. Tavolino Soori in metallo con finitura bronzo anticato. Tappeto Frame perla. In questa pagina: tavolino Henry con struttura in rovere spessart e piano in vetro lucido bordeaux.

Previous page: Henry coffee table with structure in black elm and top in glossy glass bordeaux. Jane sofa with removable cover in fabric Orleans 12 carbone and base in black elm. Soori coffee table in metal with antique bronze finish. Carpet Frame perla. This page: Henry coffee table with structure in spessart oak and top in glossy glass bordeaux.





In questa pagina: tavolini Henry con struttura in olmo nero, piani in vetro lucido arena e in marmo calacatta oro levigato. Nella pagina successiva: tavolino Henry con struttura in olmo nero e piano in vetro lucido bordeaux.

This page: Henry coffee tables with structure in black elm, top in glossy glass arena and in mat marble calacatta oro. Next page: Henry coffee table with structure in black elm and top in glossy glass bordeaux.







## HENRY

Design Emmanuel Gallina, 2017

Struttura in massello, finitura in rovere spessart o olmo nero. Piano in marmo levigato e lucido o in vetro lucido nei colori ghiaccio, arena, grafite e bordeaux.

Structure in solid wood, spessart oak or black elm finish. Top in mat and glossy marble or in glossy glass in the colours ghiaccio, arena, grafite and bordeaux.

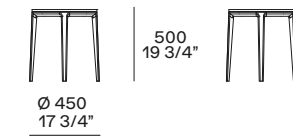
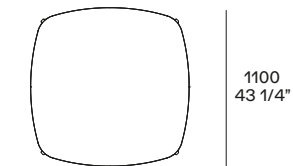
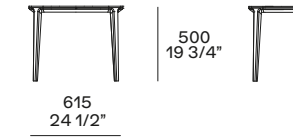
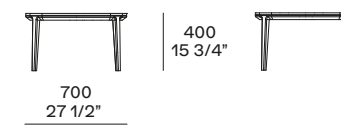
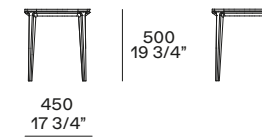

# ORBIT



Gioiello di essenzialità, Orbit è un tavolino realizzato interamente in vetro la cui semplicità nasconde una lavorazione laboriosa e complessa. Visivamente leggero e minimale, ha tuttavia un aspetto scultoreo che lo mette in dialogo con qualsiasi ambiente, dal più classico al più contemporaneo.

A gem of minimalism, Orbit is a coffee table made entirely of glass whose simplicity hides a laborious and complex manufacturing process. Visually light and minimal, yet with a sculptural look that connects it with any environment, from the most classic to the most contemporary.



Qui e nella pagina precedente: tavolini Orbit con piano e struttura in vetro bronzato, struttura in vetro soffiato. Divano Saint-Germain in tessuto sfoderabile Siro 01 bianco, cuscini in tessuto Brest 11 cioccolato, velluto Persia 2002 bruciato e velluto Glasgow 01 crema, piedini brown nickel opaco. Poltrone Le Club in pelle non sfoderabile Silk 06 roccia. Tavolino Koishi con piano in marmo sahara noir levigato finitura poliesteri, struttura brunito opaco. Tappeto Cannelé.

This and previous page: Orbit coffee tables with top and structure in bronzed glass, structure in blown glass. Germain sofa in removable fabric Siro 01 bianco, cushions in fabric Brest 11 cioccolato, velvet Persia 2002 bruciato and velvet Glasgow 01 crema, mat brown nickel feet. Le Club armchairs in non-removable leather Silk 06 roccia. Koishi coffee table with tops in mat marble sahara noir polyester finish, mat brunito structure. Carpet Cannelé.





Qui e nella pagina successiva: tavolini Orbit con piano e struttura in vetro bronzato, struttura in vetro soffiato. Divano Saint-Germain in tessuto sfoderabile Siro 01 bianco, piedini brown nickel opaco. Tappeto Cannelé.

This and next page: Orbit coffee tables with top and structure in bronzed glass, structure in blown glass. Germain sofa in removable fabric Siro 01 bianco, mat brown nickel feet. Carpet Cannelé.





## ORBIT

Design Jean-Marie Massaud, 2020

Piano e struttura in vetro bronzato, struttura in vetro soffiato.

Top and structure in bronzed glass, structure in blown glass.

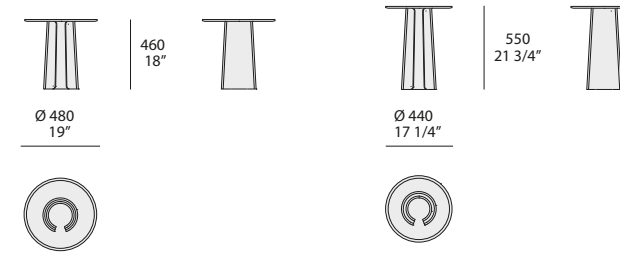





# NARA



Tavolino o sgabello, pouf o comodino: Nara è un complemento trasversale, ideale nei più diversi contesti. Disegnato da Jean-Marie Massaud, è realizzato in legno massello e caratterizzato dalla base lavorata.

Coffee table or stool, footstool or bedside table: Nara is a universal complement, ideal in the most diverse contexts. Designed by Jean-Marie Massaud, it is made of solid wood and characterized by an elaborate base.





Qui e nella pagina precedente: tavolini Nara con piano e struttura in legno massello noce gold. Divano Westside con rivestimento sfoderabile in tessuto Arcadia 02 sabbia, cuscini in velluto Tebe 06 giada, schienale mobile in cuoio 26 invecchiato, basamento in brown nickel opaco. Tappeto Tratto carbone.

This and previous page: Nara coffee tables with top and structure in solid wood gold walnut. Westside sofa with removable cover in fabric Arcadia 02 sabbia, cushions in velvet Tebe 06 giada, movable backrest in hide 26 invecchiato, mat brown nickel base. Carpet Tratto carbone.





Qui e nella pagina successiva: tavolini Nara con piano e struttura in legno massello tinto olmo nero. Letto Jacqueline con testata e base imbottite, rivestimento sfoderabile in tessuto Lima 67 pernice e cuciture a cordoncino in colore nero, rulli in pelle sfoderabile Silk 10 terracotta, biancheria da letto coordinata in cotone Provence 01 bianco e 08 polvere con profili nero. Tappeto Plain natural.

This and next page: Nara coffee tables with top and structure in solid wood stained black elm. Jacqueline bed with padded headboard and base, removable cover in fabric Lima 67 pernice and drawstring stitchings in black colour, roll cushions in removable leather Silk 10 terracotta, coordinated bed linen in cotton Provence 01 bianco and 08 polvere with black profiles. Carpet Plain natural.







## NARA

Design Jean-Marie Massaud, 2019

Struttura e piano in legno massello  
noce gold o tinto olmo nero.

Structure and top in solid wood gold  
walnut or stained black elm.

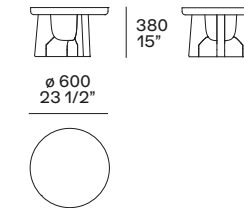
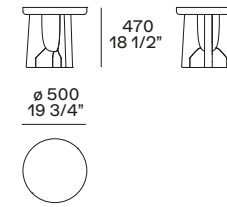

# SOORI



Ispirato a Bali e alla sua cultura, e in particolare ai vasi tradizionali utilizzati nei villaggi di questa paradisiaca isola indonesiana, Soori è un tavolino dall'estetica originale e riconoscibile. Disegnato da Soo Chan, è disponibile in tre misure in metallo con finitura bronzo anticata e, nel caso del più piccolo, anche in laccato opaco.

Inspired by Bali and its culture, and in particular by the traditional vases used in the villages of this paradisiacal Indonesian island, Soori is a coffee table with an original and recognizable look. Designed by Soo Chan, it is available in three sizes in metal with antique bronze finish and, for the smaller one, also in mat lacquer.



Qui e nella pagina precedente: tavolino Soori in metallo finitura bronzo anticato. Poltrona Santa Monica con rivestimento sfoderabile in pelle Nabuk 02 tortora.

This and previous page: Soori coffee table in metal with antique bronze finish. Santa Monica armchair with removable cover in leather Nabuk 02 tortora.

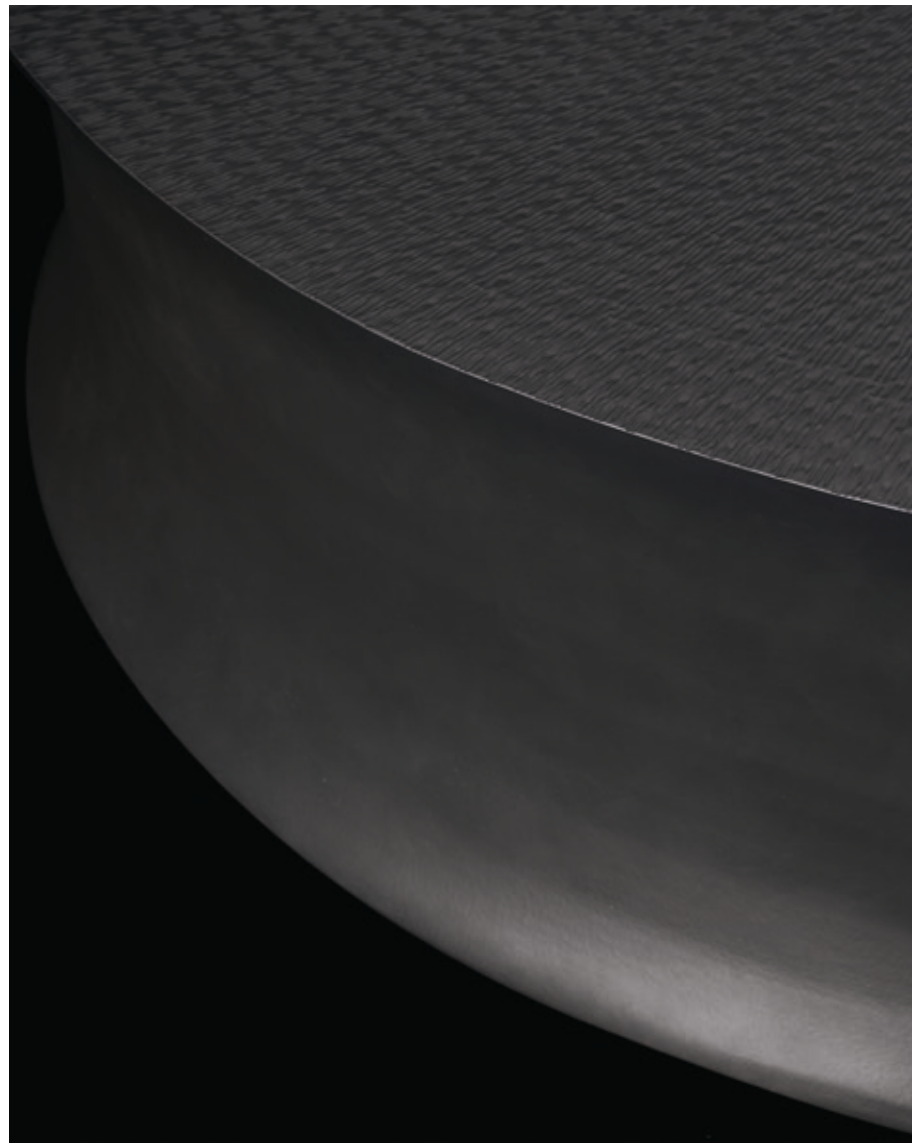





Qui e nella pagina successiva: tavolini Soori in metallo finitura bronzo anticato. Poltrone Gentleman Relax e pouf Gentleman in tessuto sfoderabile Siro 02 lino, divano Gentleman's Friends in velluto sfoderabile Tebe 08 notte, basamento in brown nickel lucido. Madia Code in noce gold, vano a giorno in laccato opaco champagne con schienale in specchio bronzo e luce a led integrata, basamento con piedini in champagne opaco. Composizione sospesa Code con mensolone retroilluminato in laccato metallico ottone, boiserie in laccato opaco canapa con profili in champagne opaco, libreria in laccato opaco ottone con schienali in noce gold. Tappeto Plain tortora.

This and next page: Soori coffee tables in metal with antique bronze finish. Gentleman Relax armchairs and Gentleman pouf in removable fabric Siro 02 lino, Gentleman's Friends sofa in removable velvet Tebe 08 notte. Code sideboard in gold walnut, open compartment in mat lacquer champagne with back in bronzed mirror and integrated led light, base with feet in mat champagne. Wall mounted Code composition with backlit thick shelf in metal lacquer ottone, wall panelling in mat lacquer canapa with mat champagne profiles, bookcase in mat lacquer ottone with backs in gold walnut. Carpet Plain tortora.

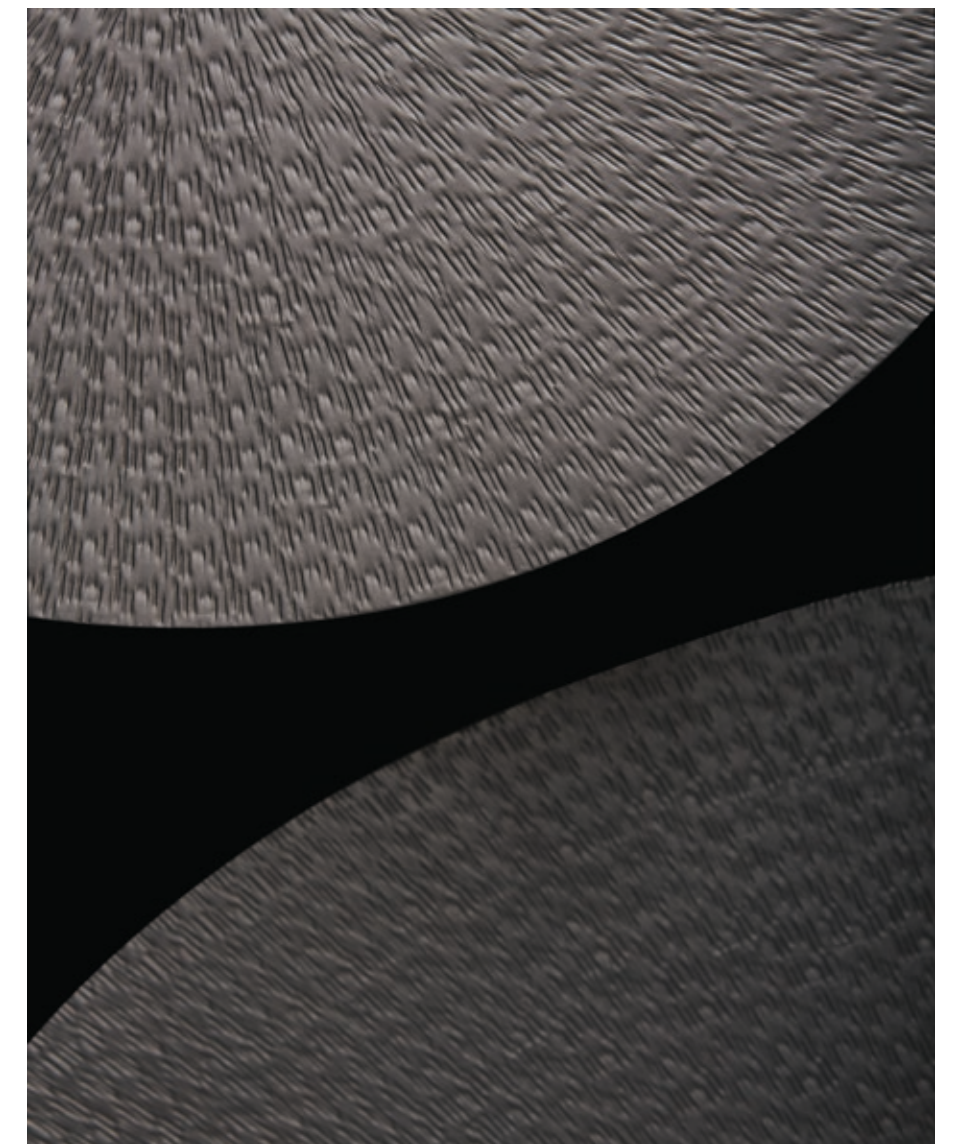



## SOORI

Design Soo Chan, 2011

Struttura e piano in metallo finitura bronzo anticato. Il tavolino piccolo è disponibile anche in poliuretano laccato opaco colori.

Structure and top in metal with antique bronze finish. The small coffee table is available also in mat lacquered polyurethane in the colours as per sample book.

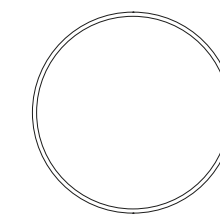
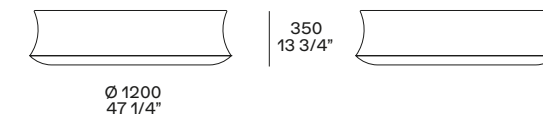
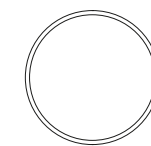
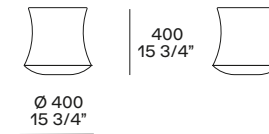



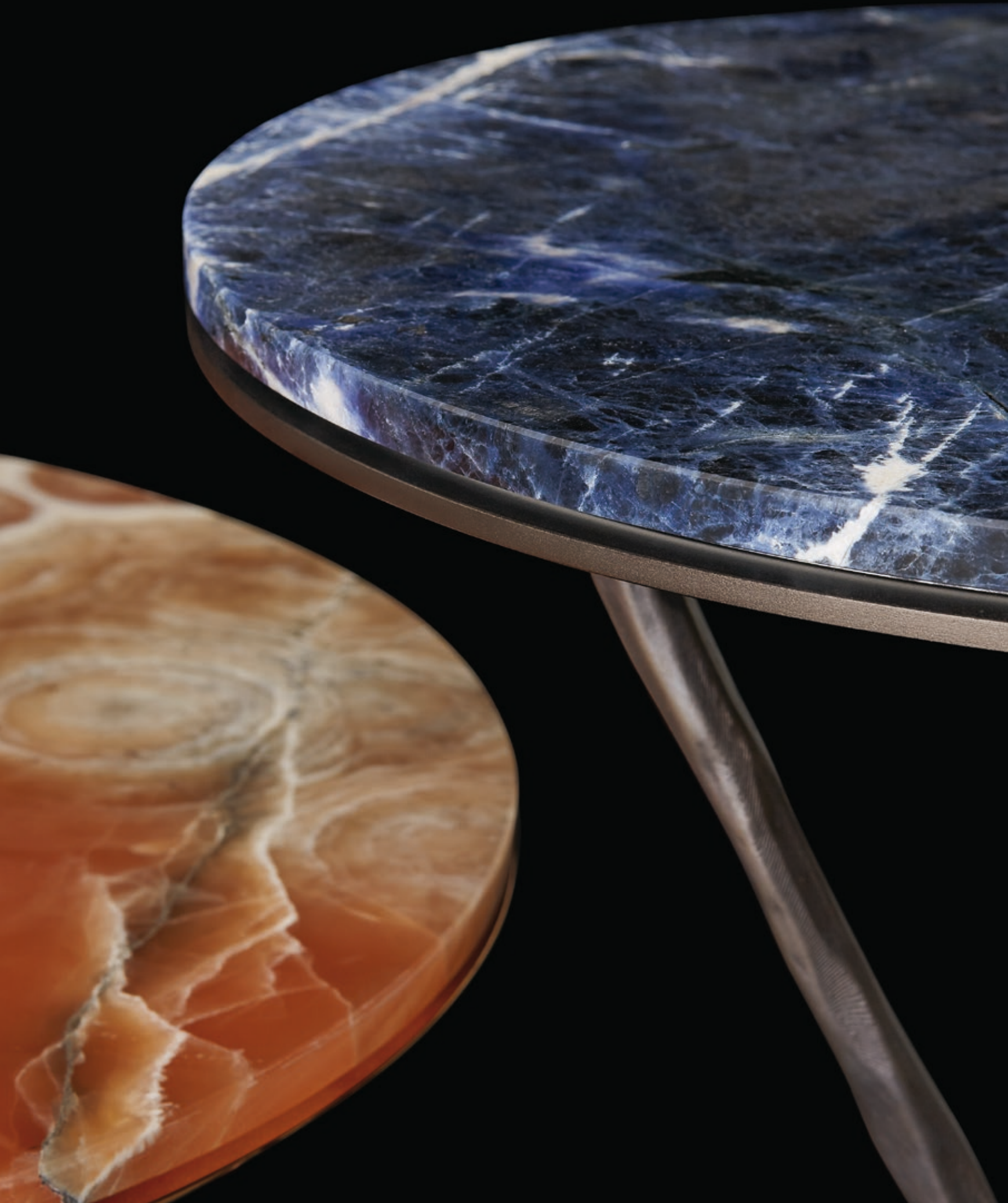

# ILDA



I tavolini Ilda sono veri e propri gioielli perché la struttura portante è una fusione di ottone, lucidata oro o bronzata, forgiata in una fonderia artistica e rifinita a mano. I piani sono in marmo, onice ambra o lapislazzuli. Un progetto prezioso, di grande impatto visivo, firmato Jean-Marie Massaud.

Ilda coffee tables are true gems, as the supporting structure is a fusion of brass, polished with gold or bronze, forged in an artistic foundry, and finished by hand. The tops are in marble, amber onyx, or lapis lazuli. A precious project of great visual impact by Jean-Marie Massaud.





Nella pagina precedente: tavolino Ilda con struttura in fusione d'ottone bronzata e piano in lapislazzulo blu. Letto Dream con pannellatura a muro rivestita in tessuto sfoderabile Skyros 02 sabbia e giroletto in pelle sfoderabile Soft 02 mastice. In questa pagina: tavolini Ilda con struttura in fusione d'ottone lucidata oro e piano in marmo calacatta oro levigato.

Previous page: Ilda coffee table with structure in bronzed brass casting and top in blue lapis lazuli. Dream bed with wall panelling covered in removable fabric Skyros 02 sabbia and bedframe in removable leather Soft 02 mastice. This page: Ilda coffee tables with structure in gold polished brass casting and top in mat marble calacatta oro.





In questa pagina: tavolini Ilda, basso con struttura in fusione d'ottone lucidata oro e piano in onice ambra, alto con struttura in fusione d'ottone bronzata e piano in marmo noir saint laurent lucido. Nella pagina successiva: tavolini Ilda con struttura in fusione d'ottone bronzata e piano in lapislazzulo blu. Poltrona Santa Monica con rivestimento sfoderabile in pelle Nabuk 02 tortora.

This page: Ilda coffee tables, low version with structure in gold polished brass casting and top in glossy marble noir saint laurent. Next page: Ilda coffee tables with structure in bronzed brass casting and top in blue lapis lazuli. Santa Monica armchair with removable cover in leather Nabuk 02 tortora.







## ILDA

Design Jean-Marie Massaud, 2017

Struttura in fusione di ottone, finiture bronzato o lucidato oro.  
Piano in onice ambra, lapislazzulo blu o marmo levigato e lucido.

Structure in brass casting in bronzed or gold polished finish.  
Top in onyx amber, blue lapis lazuli or mat and glossy marble.

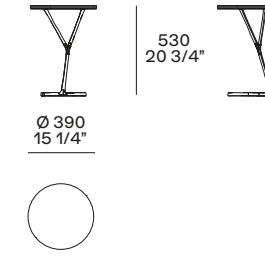
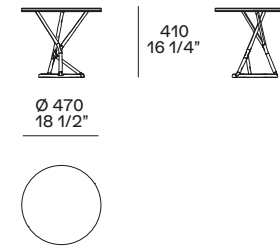



# DAMA



Dama è un tavolino dall'estetica essenziale e riconoscibile: caldo e familiare nella versione in cedro o noce, diventa monolitico e contemporaneo nella versione laccata lucida o opaca.

Dama is a coffee table with a minimalistic and recognizable look: warm and familiar in the cedar or walnut version, it becomes monolithic and contemporary in the glossy or mat lacquered version.





Nella pagina precedente: tavolino Dama in legno massello noce. Poltrona Mad Joker con rivestimento non sfoderabile, esterno in pelle Soft 14 oliva e interno in tessuto Zante 07 oliva, basamento girevole in brown nickel lucido. Pouf Mad con rivestimento sfoderabile, esterno in pelle Soft 14 oliva e interno in tessuto Zante 07 oliva, basamento fisso in brown nickel lucido. In questa pagina: tavolini Dama nella versione massello di cedro e noce.

Previous page: Dama coffee table in solid wood walnut. Mad Joker armchair with non-removable cover, outer cover in leather Soft 14 oliva and inner cover in fabric Zante 07 oliva, swivel base in glossy brown nickel. Mad pouf with removable cover, outer cover in leather Soft 14 oliva and inner cover in fabric Zante 07 oliva, fixed base in glossy brown nickel. This page: Dama coffee tables in the version solid cedar and walnut.







In questa pagina: tavolini Dama nella versione laccata, lucido nei colori corda, canapa e granata, opaco nel colore roccia. Nella pagina successiva: tavolino Dama in laccato lucido canapa. Poltrona Mad Chair con rivestimento sfoderabile in pelliccia Cashmere bianco e gambe in olmo nero. Composizione Quid con bacheche a giorno in olmo nero. Tappeto Frame gold.

This page: Dama coffee tables in the lacquered version, glossy colours corda, canapa and granata, mat colour roccia. Next page: canapa glossy lacquered Dama coffee table. Mad Chair armchair with removable cover in fur Cashmere bianco and legs in black elm. Quid composition with open display cases in black elm. Carpet Frame gold.





## DAMA

R&D Poliform, 2005

Tavolino in massello di cedro o noce.  
Tavolino in poliuretano stampato, finitura  
laccato opaco colori o laccato lucido colori.

Coffee table in solid cedar or walnut.  
Coffee table in moulded polyurethane in  
the finish mat lacquered colours or glossy  
lacquered colours.

### **Versione massello** **Version in solid wood**



Ø 320 - 340  
12 1/2" - 13 1/2"



### **Versione laccato** **Version in lacquer**

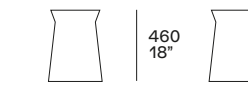

Ø 360 - 380  
14 1/4" - 15"







# BABA

Baba è un servetto che completa ogni situazione con stile ed eleganza. Versatile e informale, è caratterizzato da una struttura in metallo verniciato o laccato opaco e dal piano d'appoggio in marmo, vetro e in tutti i colori della gamma laccato opaco.

Baba is a side table that completes every situation with style and elegance. Versatile and informal, it is characterized by a painted or mat lacquered metal structure and by a top in marble, glass, and in all the colours of the mat lacquered range.





Nella pagina precedente: tavolino Baba con struttura in metallo verniciato oro lucido e piano in vetro oro. Divano Bristol in tessuto sfoderabile Naxos 17 corda e cuscini in tessuto Zante 10 nero. Tappeto Frame carbone. In questa pagina: tavolino Baba con struttura in metallo verniciato brown nickel opaco e piano in marmo grigio stardust levigato.

Previous page: Baba coffee table with structure in glossy gold painted metal and gold glass top. Sofa Bristol covered in removable fabric Naxos 17 corda and cushions in fabric Zante 10 nero. Carpet Frame carbone. This page: Baba coffee table with structure in mat brown nickel painted metal and top in mat marble grigio stardust.





In questa pagina: tavolino Baba con struttura in metallo verniciato oro lucido e piano in vetro oro. Sotto: dettaglio dei piani in marmo noir saint laurent lucido e in vetro oro. Nella pagina successiva: tavolino Baba con struttura in metallo verniciato oro lucido e piano in vetro oro. Divano Bristol in tessuto sfoderabile Naxos 17 corda. Tappeto Frame carbone.

This page: Baba coffee table with structure in glossy gold painted metal and top in gold glass. Below: close up of the tops in glossy marble noir saint laurent and in gold glass. Next page: Baba coffee table with structure in glossy gold painted metal and gold glass top. Sofa Bristol in removable fabric Naxos 17 corda. Carpet Frame carbone.







## BABA

Design Roberto Barbieri, 2012

Struttura in metallo verniciato brown nickel opaco e lucido, oro lucido, laccato opaco bianco o laccato opaco colori. Piano laccato opaco colori, marmo levigato e lucido o vetro oro. Piano vetro oro disponibile solo con struttura verniciato oro lucido.

Structure in painted metal mat and glossy brown nickel, glossy gold, mat lacquered bianco or mat lacquered colours. Top mat lacquered colours, mat and glossy marble or gold glass. Top in gold glass available only with glossy gold structure.

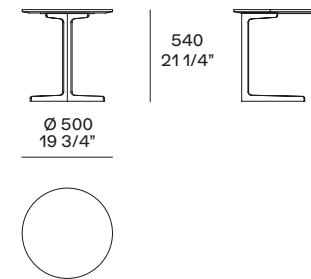

# FLUTE



Come il tavolo Flute, anche il tavolino è un omaggio di Roberto Barbieri a forme sottili e pulite. Per la sua semplicità, unita a numerosi colori e finiture disponibili, si inserisce con eleganza in ogni contesto, accanto al divano o come comodino nella zona notte.

Like the Flute table, the coffee table too is a tribute by Roberto Barbieri to thin and clean shapes. Because of its simplicity, combined with the many available colours and finishes, it fits elegantly into any context, next to the sofa or as a bedside table in the night area.



Nella pagina precedente: tavolino Flute in laccato opaco granata. Divano Shangai con imbottitura in piuma, rivestimento sfoderabile in tessuto Hannover 14 grafite, cuscini Naxos 16 sabbia. In questa pagina: tavolini Flute in laccato opaco canapa e piano tavolino basso in marmo calacatta oro levigato.

Previous page: granata mat lacquered Flute coffee table. Shangai sofa with feather padding, removable cover in fabric Hannover 14 grafite, cushions Naxos 16 sabbia. This page: canapa mat lacquered Flute coffee tables, top of the low coffee table in mat marble calacatta oro.







In questa pagina: tavolino Flute alto in cromo nero e piano in vetro riflettente blu, Flute basso in brown nickel opaco e piano in marmo noir saint laurent lucido. Nella pagina successiva: tavolino Flute base in laccato opaco carbone e piano in marmo emperador dark lucido. Pouf Play in velluto sfoderabile Persia 1403 ocra. Letto Jacqueline in tessuto sfoderabile Lima 43 écreu, cucitura a cordoncino colore acciaio.

This page: high Flute coffee table in black chrome and top in blu reflecting glass, low Flute coffee table in mat brown nickel and top in glossy marble noir saint laurent. Next page: Flute coffee table with carbone mat lacquered base and top in glossy marble emperador dark. Play pouf in removable velvet Persia 1403 ocra. Jacqueline bed in removable fabric Lima 43 ecru, drawstring stitching acciaio.





## FLUTE

Roberto Barbieri, 2008

Base e piano in laccato opaco colori, laccato antigraffio nei colori bianco, carbone, grafite, e canapa; piano disponibile anche in marmo levigato o lucido.

Base verniciato brown nickel opaco e lucido o cromo nero con piano in marmo levigato o lucido. Base in cromo nero disponibile anche con piano in vetro riflettente blu.

Base and top in mat lacquered colours, anti-scratch lacquer in the colours bianco, carbone, grafite, canapa; top available also in mat and glossy marble.

Base painted mat and glossy brown nickel or black chrome with top in mat or glossy marble. Base in black chrome available also with top in blu reflecting glass.

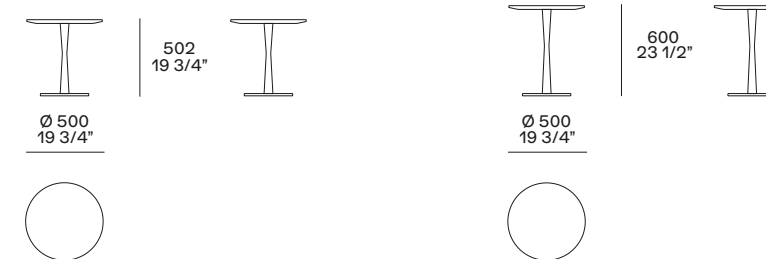



# PARIS SEOUL

Della collezione Paris Seoul, progettata da Jean-Marie Massaud, fa parte anche il tavolino. Con struttura in metallo e rivestimento esterno in cuoio, si avvicina a divani e poltrone per tenere a portata di mano quanto serve.

This coffee table is also part of the Paris Seoul collection, designed by Jean-Marie Massaud. With metal structure and external leather covering, it stand next to sofas and armchairs to keep everything you need at your fingertips.





Qui e nella pagina precedente: tavolino Paris Seoul in cuoio 02 nero e interno struttura in brown nickel lucido. Divano Bellport in tessuto sfoderabile Naxos 07 cemento, cuscini in tessuto Sendai 03 fango e velluto Persia 1404 carbone, piedini champagne opaco. Composizione Wall System in rovere spessart e schienali in laccato lucido canapa. Tavolino Dama in laccato lucido granata. Tavolino Creek con piano in marmo calacatta oro lucido e laccato lucido canapa, struttura champagne satinato. Tappeto Frame grey. Nella pagina successiva: tavolino Paris Seoul in cuoio 26 invecchiato e interno struttura in brown nickel lucido.

This and previous page: Paris Seoul coffee table with outer cover in hide 02 nero and inner finish glossy brown nickel. Bellport sofas in removable fabric Naxos 07 cemento, cushions in fabric Sendai 03 fango and velvet Persia 1404 carbone, feet in mat champagne. Wall System composition in spessart oak and backs in glossy lacquer canapa. Granata glossy lacquered Dama coffee table. Creek coffee table with top in glossy marble calacatta oro and canapa glossy lacquer, structure in brushed champagne. Carpet Frame grey. Next page: Paris Seoul coffee table with outer cover in hide 26 invecchiato and inner finish in glossy brown nickel.

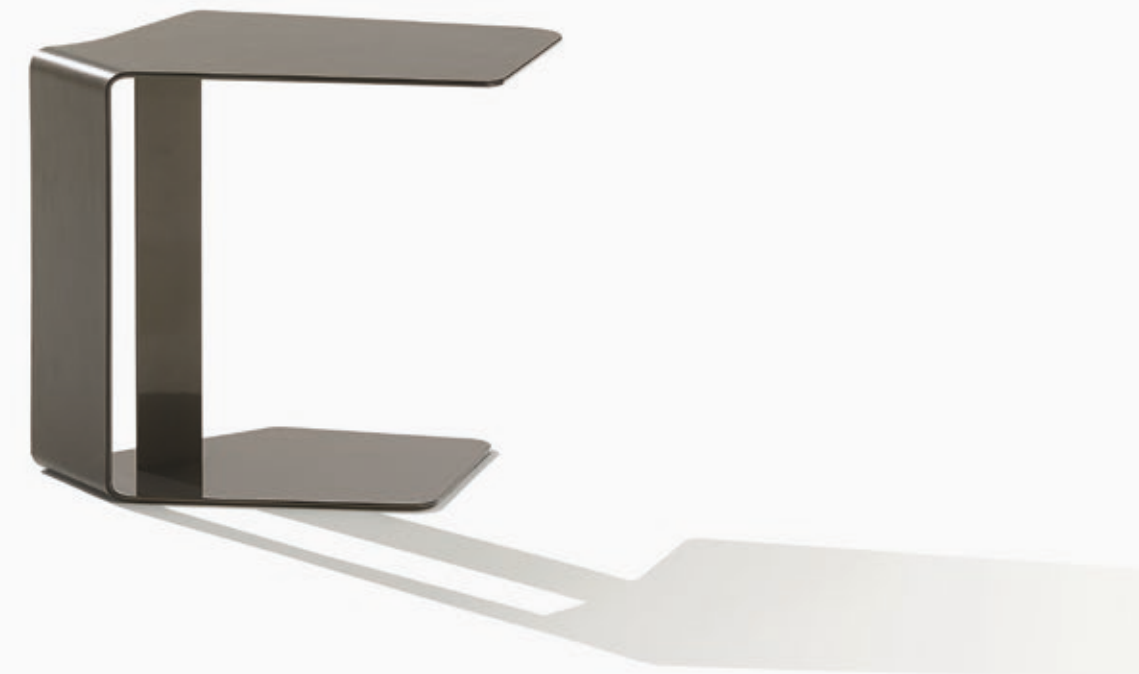

## PARIS SEOUL

Design Jean-Marie Massaud, 2012

Struttura in metallo, all'interno verniciato  
brown nickel opaco o lucido, all'esterno  
rivestito in cuoio colori.

Structure in metal, inner finish mat or glossy  
brown nickel painted metal, outer cover in  
hide in the available colours.

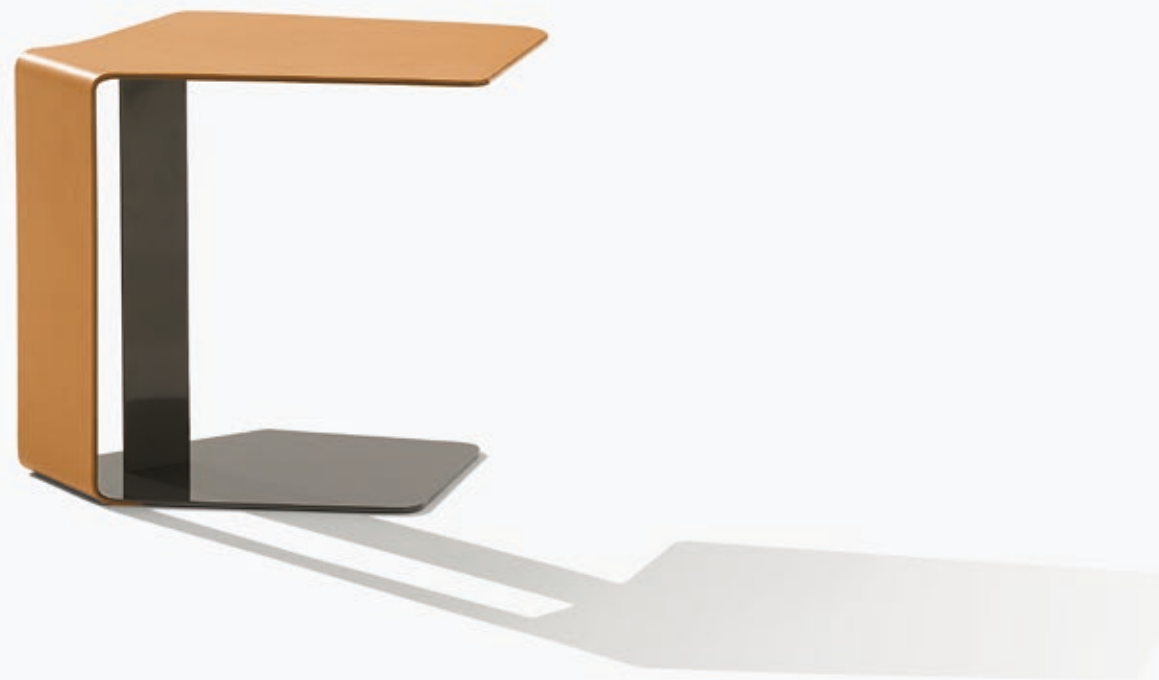
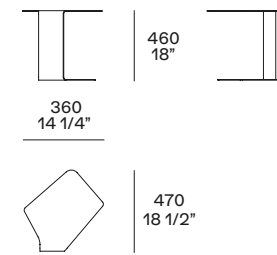



# POUFS

I pouf sono complementi eleganti e versatili – poggiatesta, tavolini e sedute allo stesso tempo. Classici abbinati a poltrone e divani o come sedute aggiuntive nella zona giorno, sono immancabili nella zona notte e nella cabina armadio come elementi d'appoggio. I pouf Poliform sono disegnati da Jean-Marie Massaud ed Emmanuel Gallina.

The poufs are elegant and versatile complements – footrests, coffee tables, and seats at the same time. Classic when combined with armchairs and sofas or as additional seats in the day area, they are a must in the night area and in the walk-in closet as support elements. Poliform poufs are designed by Jean-Marie Massaud and Emmanuel Gallina.

## POUFS

NEW YORK	197
HENRY	209
PLAY	219
ONDA	229
GANT	239



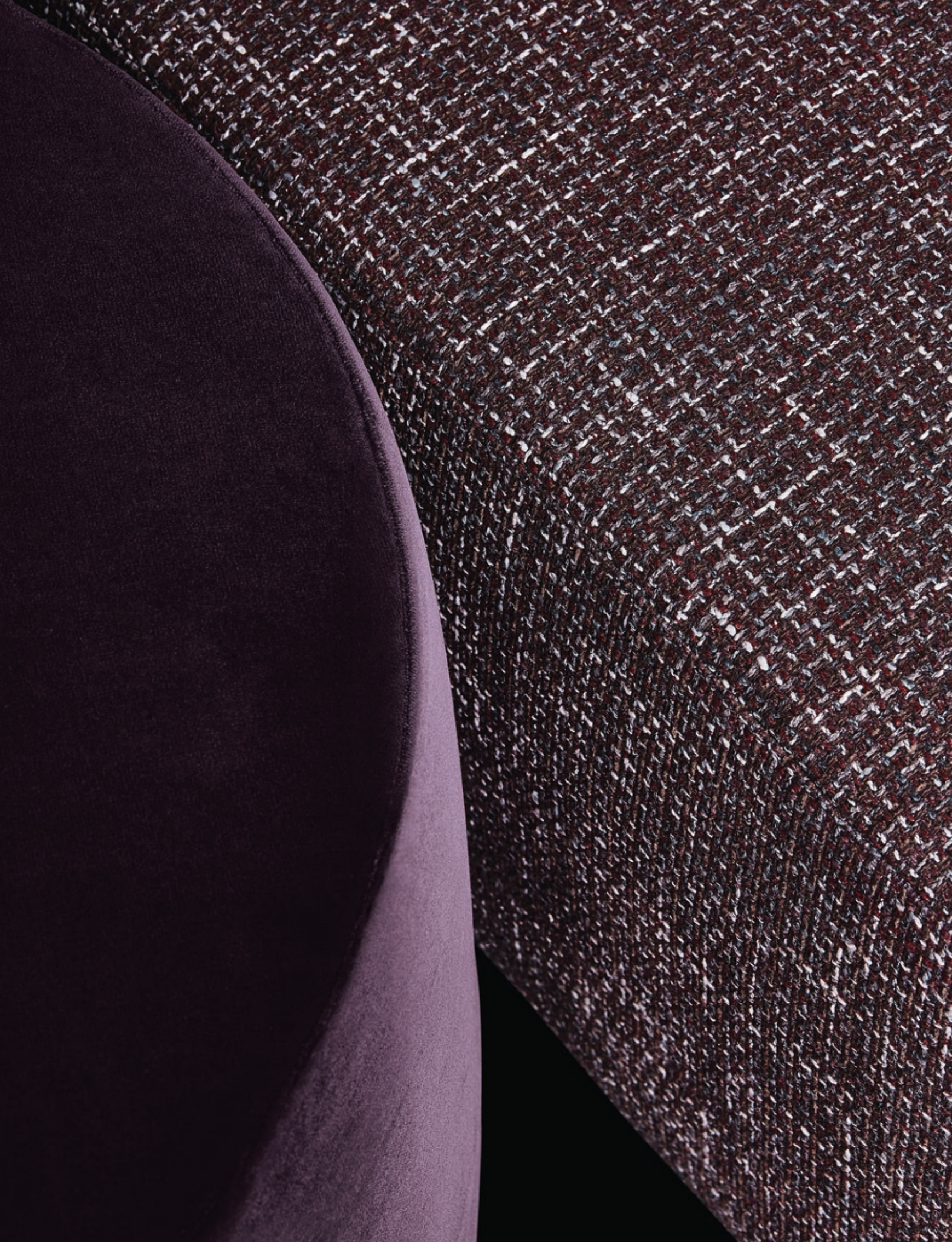

# NEW YORK



Poggiapiedi o elemento freestanding, il pouf New York è ideale accanto al divano, in camera da letto o dentro la cabina armadio. Disegnato da Jean-Marie Massaud, è valorizzato dai piedini forgiati in fonderia e caratterizzato dalle cuciture rifinite a mano, un dettaglio di alta sartoria.

Footrest or freestanding element, the New York pouf is ideal next to the sofa, in the bedroom, or inside the walk-in closet. Designed by Jean-Marie Massaud, it is enhanced by the feet forged in a foundry and characterized by hand-stitched seams, a high-tailoring detail.





Nella pagina precedente: pouf New York con rivestimento sfoderabile in tessuto Skyros 02 sabbia e non sfoderabile in pelle Soft 10 prugna, piedini brown nickel lucido. Cabina armadio Ubik con pannelli in nobilitato Skin laccato opaco 94 latte, attrezzatura in nobilitato rovere cenere, tecnocover Grain 05 latte, vetro riflettente fumé e ardesia opaco. In questa pagina: pouf New York con rivestimento sfoderabile in tessuto Olimpia 11 polvere e in velluto Persia 1404 carbone, piedini in materiale plastico.

Previous page: New York pouf with removable cover in fabric Skyros 02 sabbia and in non-removable leather Soft 10 prugna, glossy brown nickel feet. Ubik walk-in closet with backs in 94 latte mat lacquered Skin melamine, equipment in cenere oak melamine, tecnocover Grain 05 latte, fumé reflecting glass and mat ardesia. This page: New York pouf with removable cover in fabric Olimpia 11 polvere and in velvet Persia 1404 carbone, feet in plastic material.







Nella pagina precedente: pouf New York con rivestimento sfoderabile in tessuto Lipsi 15 prugna, velluto Persia 2006 prugna e non sfoderabile in pelle Nabuk 02 tortora, piedini brown nickel lucido. In questa pagina: pouf New York con rivestimento sfoderabile in tessuto Naxos 27 prussia e piedini brown nickel lucido. Nella pagina successiva: pouf New York con rivestimento sfoderabile in tessuto Naxos 16 sabbia e piedini brown nickel opaco.

Previous page: New York pouf with removable cover in fabric Lipsi 15 prugna, velvet Persia 2006 prugna and in non-removable leather Nabuk 02 tortora, glossy brown nickel feet. This page: New York pouf with removable cover in fabric Naxos 27 prussia and glossy brown nickel feet. Next page: New York pouf with removable cover in fabric Naxos 16 sabbia and mat brown nickel feet.





## NEW YORK

Design Jean-Marie Massaud, 2017

Struttura in legno e derivati. Seduta in poliuretano espanso a quote differenziate e prerivestimento in ovatta di poliestere. Piedini in materiale plastico o in metallo verniciato brown nickel opaco o lucido. Rivestimento in tessuto sfoderabile o pelle non sfoderabile.

Structure in wood and wood by-products. Seat in multi-density polyurethane foam and pre-cover in polyester wadding. Feet in plastic material or in painted metal mat or glossy brown nickel. Cover in removable fabric or non-removable leather.

### Piedini in metallo Feet in metal

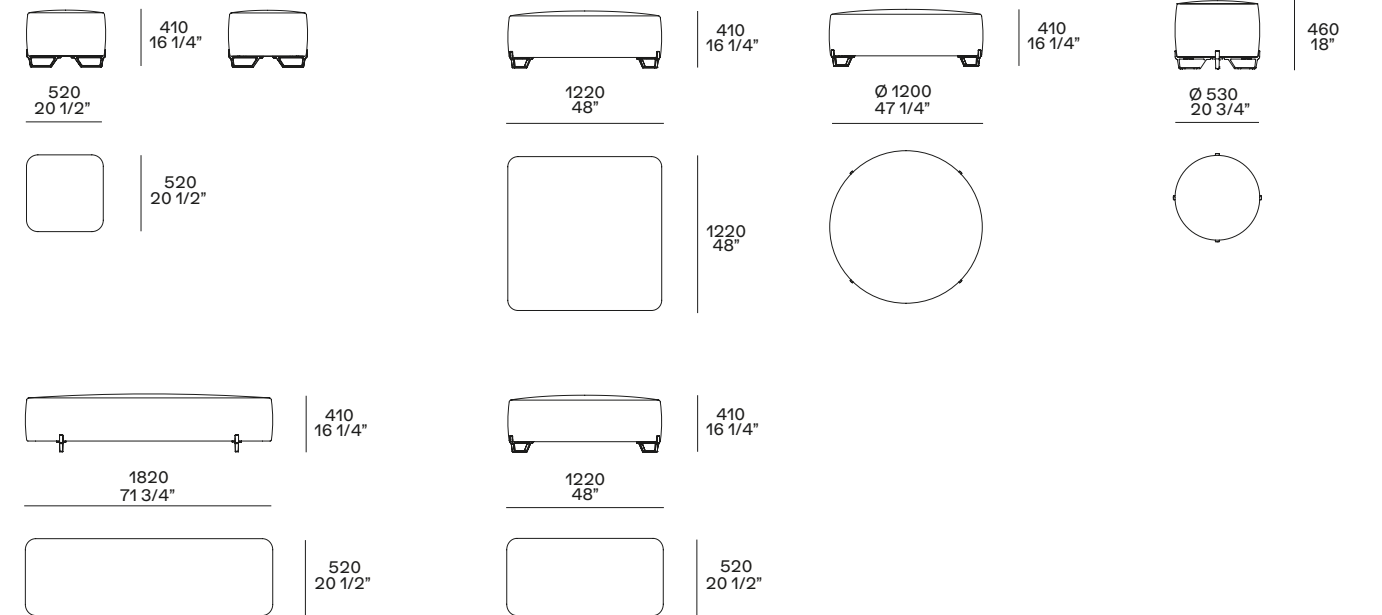

### Piedini in materiale plastico Feet in plastic material

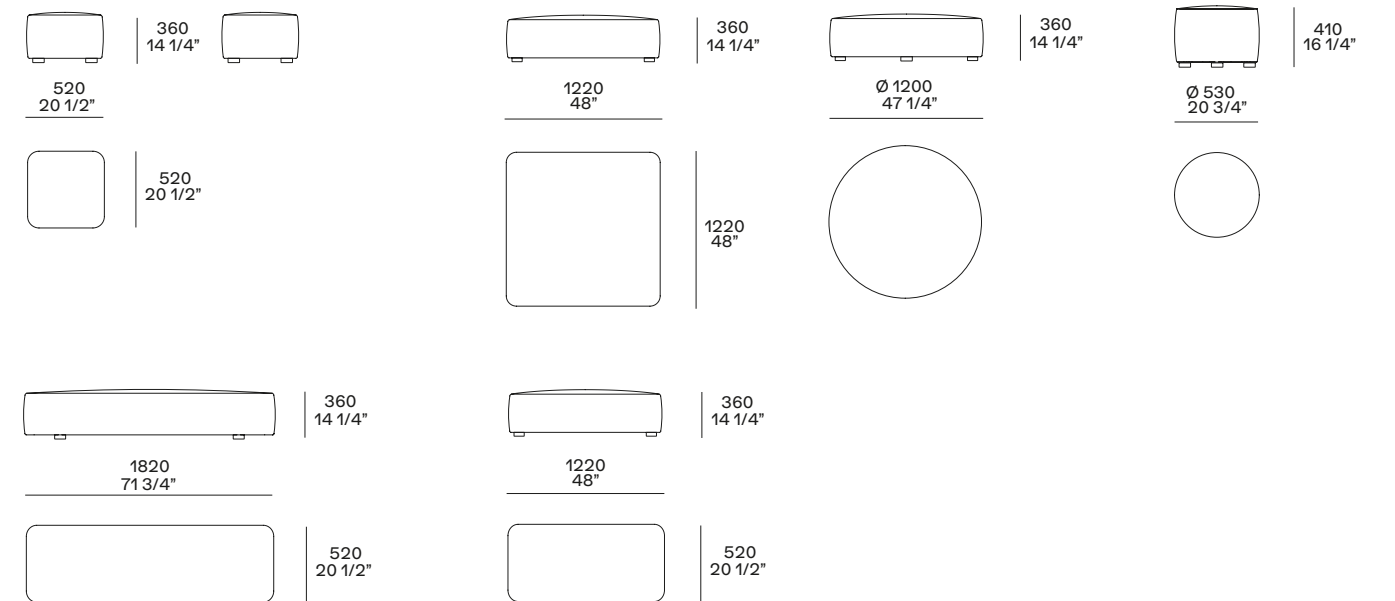





# HENRY



Emmanuel Gallina disegna un complemento eclettico – pouf, sgabello e tavolino allo stesso tempo. Sulla base in essenza, l'imbottitura tonda o rettangolare è disponibile con rivestimento in tessuto o pelle.

Emmanuel Gallina designs an eclectic complement – pouf, stool, and coffee table at the same time. On the wooden base, the round or rectangular padding is available in fabric or leather.





Nella pagina precedente: pouf Henry con rivestimento non sfoderabile in velluto Persia 1404 carbone e struttura in olmo nero. Composizione Quid con boiserie in olmo nero e profili in brown nickel opaco, mensole in laccato opaco moka e cuoio 29 tortora. Contenitori sospesi in vetro riflettente blu con piano in marmo noir saint laurent lucido e fianchi laterali in olmo nero. Tappeto Frame carbone. In questa pagina: pouf Henry con rivestimento non sfoderabile in pelle Nabuk 09 ruggine e struttura in olmo nero.

Previous page: Henry pouf with non-removable cover in velvet Persia 1404 carbone and black elm structure. Quid composition with wall panelling in black elm and mat brown nickel profiles, shelves in moka lacquer and hide 29 tortora. Hanging storage units in blu reflecting glass with top in glossy marble noir saint laurent, lateral side panels in black elm. Carpet Frame carbone. This page: Henry pouf with non-removable cover in leather Nabuk 09 ruggine and black elm structure.





In questa pagina: pouf Henry con rivestimento non sfoderabile in tessuto Kitami 02 cenere e struttura in olmo nero. Nella pagina successiva: pouf Henry con rivestimento non sfoderabile in velluto Persia 1404 carbone e struttura in olmo nero. Divano Bristol in tessuto sfoderabile Naxos 17 corda, cuscini Zante 10 nero. Poltrona Jane in velluto sfoderabile Persia 54 prussia e basamento in olmo nero. Tavolino Baba in metallo verniciato oro lucido e piano in vetro oro. Tavolino Home Hotel in olmo nero. Tappeto Frame carbone.

This page: Henry pouf with non-removable cover in fabric Kitami 02 cenere and black elm structure. Next page: Henry pouf with non-removable cover in velvet Persia 1404 carbone and structure in black elm. Bristol sofa in removable fabric Naxos 17 corda, cushions in Zante 10 nero. Jane armchair in removable velvet Persia 54 prussia and base in black elm. Baba coffee table in glossy gold painted metal and top in gold glass. Home Hotel coffee table in black elm. Carpet Frame carbone.







## HENRY

Design Emmanuel Gallina, 2017

Struttura in massello, finitura rovere spessart o olmo nero. Seduta in poliuretano espanso a quote differenziate. Prerivestimento parti in tela cotone con piuma e parti in ovatta di poliestere accoppiata. Rivestimento non sfoderabile in tessuto o pelle.

Solid wood structure finish spessart oak or black elm. Seat in multi-density polyurethane foam. Pre-cover with parts in cotton canvas with down and parts in coupled polyester wadding. Non-removable cover in fabric and leather.

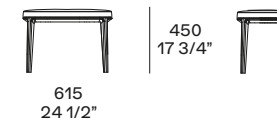
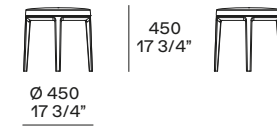





# PLAY



Il pouf Play unisce a linee semplici il comfort dell'imbottitura e del rivestimento in tessuto o pelle, anche con lavorazioni particolari come il fondo piega, la cucitura matelassé e la pelle intrecciata.

The Play pouf combines simple lines with the comfort of the padding and upholstery in fabric or leather, also with particular details such as the slipcover, the matelassé stitching, and the woven leather.



Nella pagina introduttiva: pouf Play con rivestimento sfoderabile in tessuto Zante 17 melanzana e in pelle non sfoderabile Nabuk intrecciata 01 latte. Nella pagina precedente: pouf Play con rivestimento sfoderabile in velluto Gibson matelassé 07 grafite. Composizione Quid con boiserie in olmo nero, bacheche con struttura in laccato opaco piombo e cassetti in olmo nero. In questa pagina: pouf Play con rivestimento non sfoderabile in pelle Nabuk 01 latte e su 3 facciate centrali in pelle Nabuk intrecciata 01 latte.

Introduction page: Play pouf with removable cover in fabric Zante 17 melanzana and in non-removable woven leather Nabuk 01 latte. Previous page: Play pouf with removable cover in velvet Gibson matelassé 07 grafite. Quid composition with wall panelling in black elm, open display cases with piombo mat lacquered structure and black elm drawers. This page: Play pouf with non-removable cover in leather Nabuk 01 latte and on the three central sides in woven leather Nabuk 01 latte.







In questa pagina: pouf Play con rivestimento sfoderabile versione fonda-  
dopiega in tessuto Skyros 05 ghiaccio. Nella pagina successiva: pouf  
Play con rivestimento sfoderabile in velluto Persia 58 danubio. Cabina  
armadio Ubik con pannelli a parete in vetro acidato bronzo e attrezza-  
ture in nobilitato rovere cenere e ardesia opaco.

This page: Play pouf with removable slipcover in fabric Skyros 05 ghi-  
accio. Next page: Play pouf with removable slipcover in velvet Persia  
58 danubio. Ubik walk-in closet with etched glass bronzo wall panels  
and equipment in cenere oak melamine and mat ardesia.





## PLAY

Design R&D Poliform, 2003

Struttura in legno e derivati. Seduta in poliuretano espanso a quote differenziate e prerivestimento in fibra di poliestere accoppiata. Piedini in materiale plastico. Rivestimento versione tesato sfoderabile in tessuto o non sfoderabile in pelle. Rivestimento Gibson matelassé e pelle intrecciata (su tre facciate centrali del pouf) solo per la versione rivestimento tesato. Rivestimento versione fondopiega sfoderabile in tessuto.

Structure in wood and wood-by products. Seat in multi-density polyurethane foam and pre-cover in polyester fibre. Feet in plastic material. Version with stretched cover removable in fabric and non-removable in leather. Cover Gibson matelassé and woven leather (on the three central sides of the pouf) only for the version with stretched cover. Version with slipcover removable in fabric.

### Rivestimento tesato Stretched cover

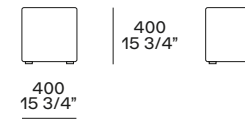

### Rivestimento fondopiega Slipcover

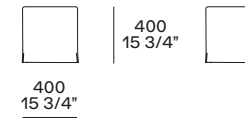



# ONDA

Un cubo perfetto con un'impuntura centrale che ne sottolinea comodità e morbidezza. Il pouf Onda, disegnato da Poliform, completa il divano della zona giorno, diventando una comoda seduta aggiuntiva quando serve.

A perfect cube with central stitching that emphasizes its comfort and softness. The Onda pouf, designed by Poliform, completes the sofa in the day area, becoming a comfortable additional seat when needed.





Nella pagina precedente: pouf Onda con rivestimento non sfoderabile in tessuto Skyros 07 grafite. Consolle Mondrian piano in marmo noir saint laurent lucido e struttura in fusione di bronzo lucidata oro. Divano Mondrian in tessuto sfoderabile Olimpia 11 polvere. Composizione Quid con boiserie in olmo nero. In questa pagina: pouf Onda con rivestimento non sfoderabile in pelle Nabuk 01 latte.

Previous page: Onda pouf with non-removable cover in fabric Skyros 07 grafite. Mondrian console with top in glossy marble noir saint laurent and structure in gold polished bronze casting. Mondrian sofa in removable fabric Olimpia 11 polvere. Quid composition with black elm wall panelling. This page: Onda pouf with non-removable cover in leather Nabuk 01 latte.





In questa pagina: pouf Onda con rivestimento non sfoderabile in tessuto Olimpia 113 porpora. Nella pagina successiva: pouf Onda con rivestimento non sfoderabile in pelle Nabuk 09 ruggine. Tavolo Kensington con struttura in spatolato bronzo e piano in olmo nero. Armadio Senzafine Ocean con ante battenti in vetro acidato bronzo, telaio e maniglie Sydney a incasso ardesia opaco. Tappeto Plain cipria.

This page: Onda pouf with non-removable cover in fabric Olimpia 113 porpora. Next page: Onda pouf with non-removable cover in leather Nabuk 09 ruggine. Kensington table with structure in metal bronzo with spatula effect and top in black elm. Wardrobe Senzafine Ocean with leaf doors in etched glass bronzo, profile and built-in Sydney handles mat ardesia. Carpet Plain cipria.

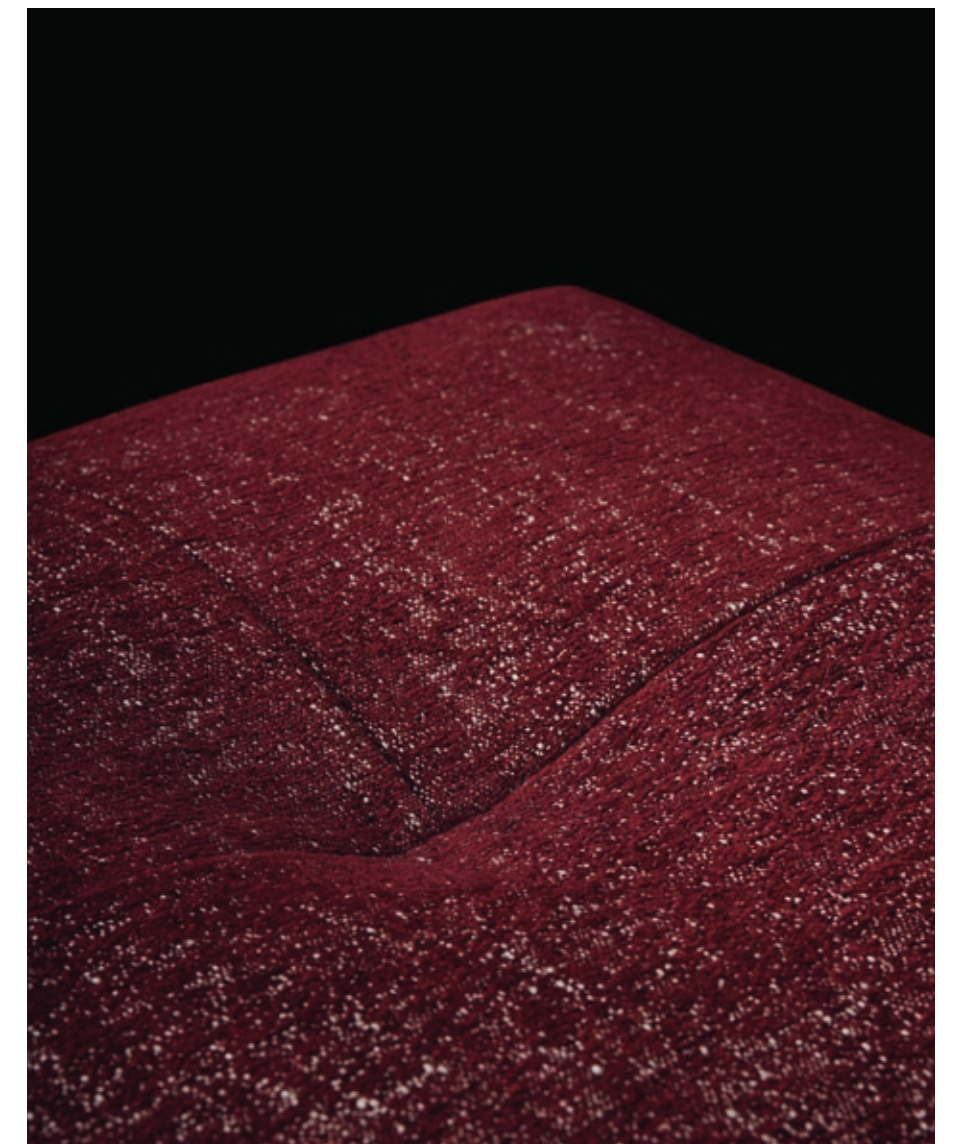





## ONDA

Design R&D Poliform, 2003

Struttura in legno e derivati. Seduta in poliuretano espanso a quote differenziate e prerivestimento in fibra di poliestere. Piedini in materiale plastico. Rivestimento non sfoderabile in tessuto o pelle, lavorazione capitonné.

Structure in wood and wood by-products. Seat in multi-density polyurethane foam and pre-cover in polyester fibre. Feet in plastic material. Non-removable cover in fabric or leather, capitonné manufacturing.

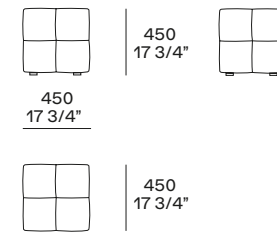



# GANT



Poliform reinterpreta in chiave attuale il classico pouf quadrato. Rivestito in tessuto o pelle con preziosa lavorazione capitonné, Gant si fa notare per la sua eleganza.

Poliform reinterprets the classic square pouf in a modern key. Covered in fabric or leather with precious capitonné style, Gant stands out for its elegance.



Nella pagina precedente: pouf Gant con rivestimento non sfoderabile in pelle Invecchiata 880 nero. Tavolino Flute in laccato opaco carbone. In questa pagina: pouf Gant con rivestimento non sfoderabile in pelle Soft 04 cognac. Sotto: dettaglio della lavorazione capitonné.

Previous page: Gant pouf with non-removable cover in leather Invecchiata 880 nero. Carbone mat lacquered Flute coffee table. This page: Gant pouf with non-removable cover in leather Soft 04 cognac. Below: close up of the capitonné manufacturing.





In questa pagina: pouf Gant con rivestimento non sfoderabile in tessuto Naxos 27 prussia. Nella pagina successiva: pouf Gant con rivestimento non sfoderabile in pelle Nabuk 01 latte. Tavolino Tribeca in brown nickel opaco con piano in marmo emperador dark lucido. Cabina armadio Senzafine in nobilitato rovere cenere. Tappeto Dama.

This page: Gant pouf with non-removable cover in fabric Naxos 27 prussia. Next page: Gant pouf with non-removable cover in leather Nabuk 01 latte. Tribeca coffee table in mat brown nickel with top in glossy marble emperador dark. Walk-in closet Senzafine in cenere oak melamine. Carpet Dama.





## GANT

Design R&D Poliform, 2010

Struttura in legno e derivati. Seduta in poliuretano espanso a quote differenziate e prriverestimento in fibra di poliestere. Piedini in materiale plastico. Rivestimento non sfoderabile in tessuto o pelle, lavorazione capitonné.

Structure in wood and wood-by products. Seat in multi-density polyurethane foam and pre-cover in polyester fibre. Feet in plastic material. Non-removable cover in fabric and leather, capitonné manufacturing.

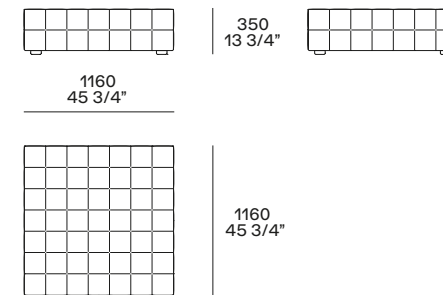



# CARPETS

Per completare i suoi arredi, Poliform propone una collezione di tappeti realizzati con tecnica handloom, una lavorazione eseguita a mano su telaio che si differenzia dai metodi di fabbricazione automatizzati e meccanici. Tappeti unici, realizzati con materiali naturali come la lana himalayana e l'aloè, morbidi e duraturi nel tempo, dagli accostamenti cromatici eleganti.

To complete its furnishings, Poliform offers a collection of carpets made with handloom technique, a hand-made manufacturing process on a loom that differs from automated and mechanical manufacturing methods. Unique carpets, made with natural materials such as Himalayan wool and aloe, soft and long-lasting, with elegant colour combinations.

## CARPETS

RELIEF	253
CANNELÉ	259
TRATTO	265
FRAME	271
PLAIN	277
SOFT	283
DAMA	289
STRIPES	295





# RELIEF



Il tappeto Relief unisce all'effetto cannettato un decoro perimetrale, ottenuto tagliando il vello ad altezze diverse. Disponibile nei colori perla, cammello e tortora, è realizzato in un blend di lana himalayana e seta di bambù, una combinazione che enfatizza la morbidezza e la piacevolezza al tatto.

The Relief carpet combines a ribbed effect with a border decoration, obtained by cutting the pile at different heights. Available in perla, cammello and tortora colours, it is made from a blend of Himalayan wool and silk bamboo, a combination that emphasises softness and is pleasant to the touch.







## RELIEF

Design R&D Poliform, 2020

Prodotto a mano con tecnica handloom.  
Trama in cotone, vello in lana himalayana  
e seta di bambù, bouclé in lana himalayana.  
Dimensioni mm: rettangolare 1700×2400  
2300×3000 - 3000×4000  
quadrato 3000×3000.

Handmade with the handloom technique.  
Cotton weave, fleece in Hymalayan wool  
and bamboo silk, Hymalayan wool bouclé.  
Dimensions in: rectangular 67"×94 1/2"  
90 1/2"×118" - 118"×157 1/2"  
square 118"×118".



Perla



Cammello



Tortora

In questa pagina e nella precedente: tappeto Relief cammello.

This and previous page: carpet Relief cammello.





# CANNELÉ



Cannelé è un tappeto bicolore caratterizzato dal motivo rigato. A definire più precisamente le righe è la giustapposizione di due lavorazioni – bouclé per il nero, vello tagliato a mano per il perla. La trama è realizzata in cotone, il vello in lana himalayana e seta di bambù, il bouclé in lana himalayana. Il tappeto è fatto a mano con la tradizionale tecnica handloom.

Cannelé is a two-coloured carpet characterized by a striped pattern. What further defines the difference of the stripes is the juxtaposition of two techniques – bouclé for the nero, hand-cut fleece for the perla. The weft is made of cotton, the fleece in Himalayan wool and bamboo silk, the bouclé in Himalayan wool. The carpet is produced by hand with the traditional handloom technique.







## CANNELÉ

Design R&D Poliform, 2020

Prodotto a mano con tecnica handloom.  
Trama in cotone, vello in lana himalayana  
e seta di bambù, bouclé in lana himalayana.  
Dimensioni mm: rettangolare 1700x2400  
2300x3000 - 3000x4000  
quadrato 3000x3000.

Handmade with the handloom technique.  
Cotton weave, fleece in Hymalayan wool  
and bamboo silk, Hymalayan wool bouclé.  
Dimensions in: rectangular 67"x94 1/2"  
90 1/2"x118" - 118"x157 1/2"  
square 118"x118".





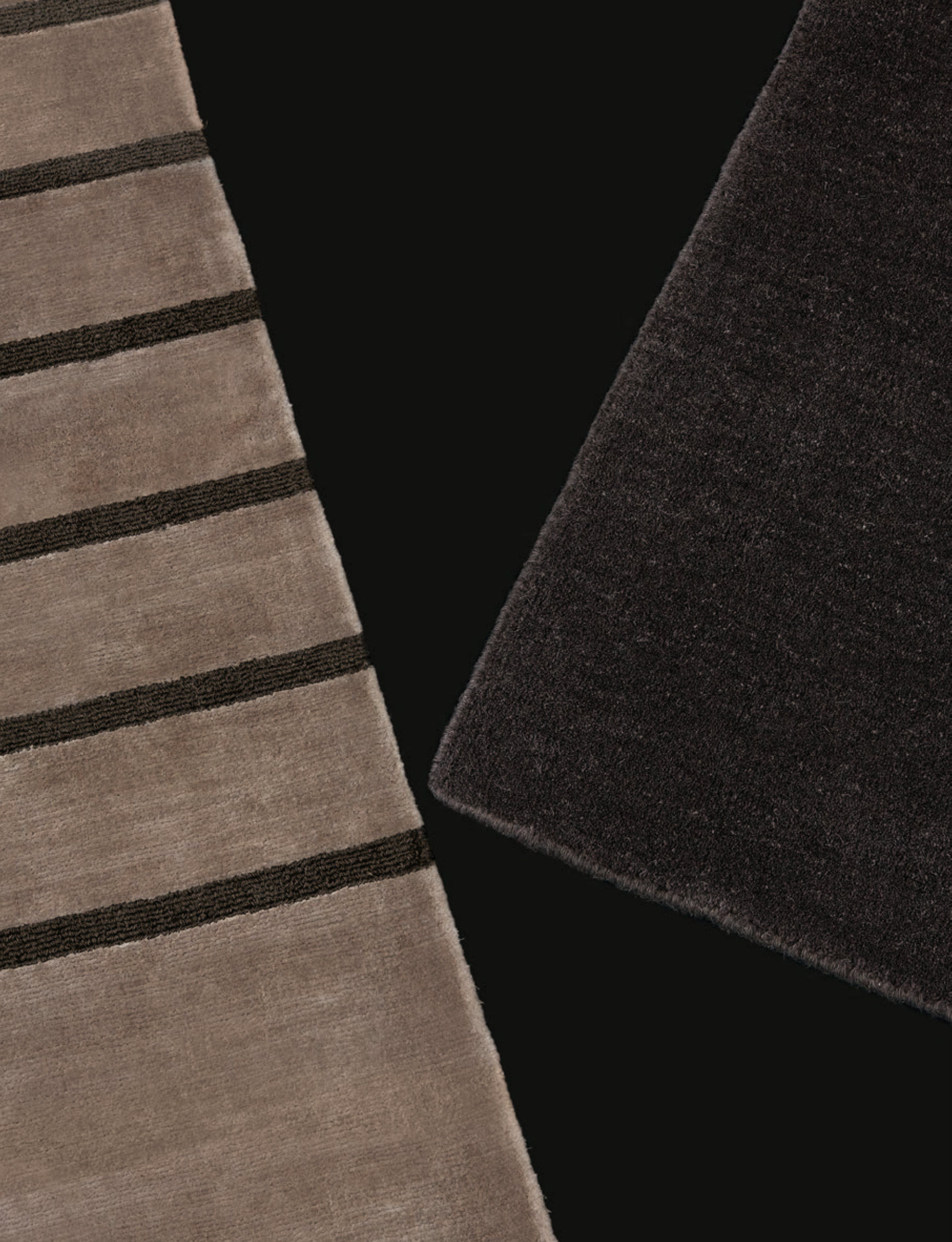

# TRATTO



Tratto è un tappeto realizzato in un blend di lana himalayana, morbida al tatto, e seta di bambù, che rende il decoro cangiante. È caratterizzato dai motivi geometrici e disponibile in tre vibranti combinazioni di colore.

Tratto is a rug made of a blend of Himalayan wool, soft to the touch, and bamboo silk, which makes the decoration iridescent. It is characterized by geometric patterns and available in three vibrant colour combinations.







## TRATTO

Design R&D Poliform, 2019

Prodotto a mano con tecnica handloom.  
Trama in cotone, vello in lana himalayana  
e seta di bambù.  
Dimensioni mm: rettangolare 1700×2400  
2300×3000 - 3000×4000  
quadrato 3000×3000.

Handmade with the handloom technique.  
Cotton weave, fleece in Hymalayan wool  
and bamboo silk.  
Dimensions in: rectangular 67"×94 1/2"  
90 1/2"×118" - 118"×157 1/2"  
square 118"×118".



Ruggine



Carbone



Tortora

Nella pagina precedente: tappeto Tratto carbone. In questa pagina  
tappeto Tratto ruggine.

Previous page: carpet Tratto carbone. This page, carpet Tratto  
ruggine.



# FRAME

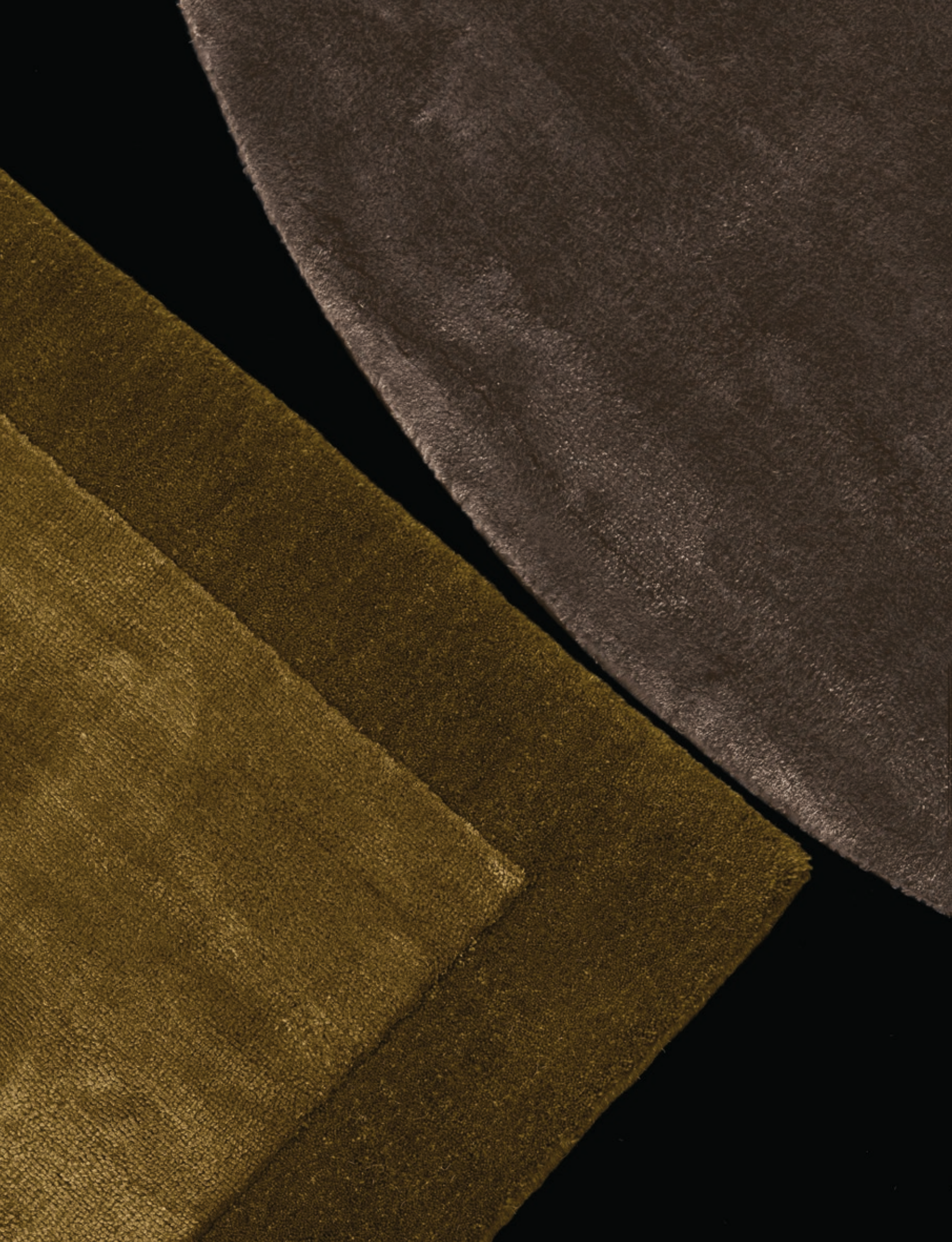



Frame è realizzato in seta di bambù, un materiale che conferisce al tappeto il suo caratteristico aspetto cangiante. Disponibile in versione ovale o rettangolare, in questa variante è caratterizzato dal bordo monocromatico in lana himalayana della stessa tinta.

Frame is made of bamboo silk, a material that gives the carpet its characteristic iridescence. Available in oval or rectangular version, the latter is characterized by the monochromatic edge in Himalayan wool of the same colour.





## FRAME

Design R&D Poliform, 2015

Prodotto a mano con tecnica handloom.  
Trama in cotone, vello in seta di bambù.  
Bordo perimetrale di 80 mm in lana  
himalayana in tinta solo per la versione  
rettangolare.  
Dimensioni mm: rettangolare 1700×2400  
2300×3000 - 3000×4000  
quadrato 3000×3000 - ovale 2300×4000.

Handmade with the handloom technique.  
Cotton weave, fleece in bamboo silk.  
80 mm - 3 1/4" perimeter edge in Himalayan  
wool in matching color only for the  
rectangular version.  
Dimensions inches: rectangular 67"x94 1/2"  
90 1/2"x118" - 118"x157 1/2"  
square 118"x118" - oval 90 1/2"x157 1/2".



Grey

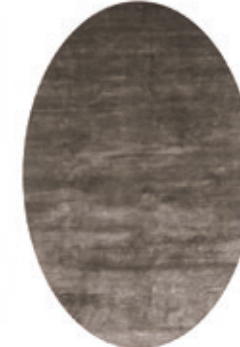

Gold

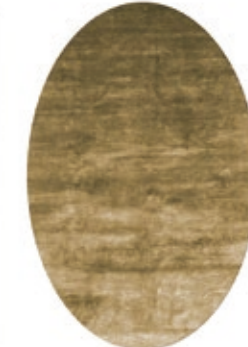

Perla



Carbone



Nella pagina precedente: tappeto Frame carbone. In questa pagina: tappeto ovale Frame perla.

Previous page: carpet Frame carbone. This page: oval carpet Frame perla.





# PLAIN



Rettangolare o tondo, il tappeto Plain è realizzato in un blend di aloe e seta di bambù, due materiali molto resistenti e di qualità eccellente. Disponibile in cinque colori, è caratterizzato in entrambe le versioni dalle sezioni più scure, in tinta.

Rectangular or round, the Plain carpet is made of a blend of aloe and bamboo silk, two very resistant materials of excellent quality. Available in five colours, it is characterized in both versions by the darker sections of the same hue.







## PLAIN

Design R&D Poliform, 2015

Prodotto a mano con tecnica handloom. Trama in cotone, vello in aloe e seta di bambù. Nella versione rettangolare fascia di 150 mm in tonalità più scura sul lato superiore e inferiore e di 100 mm per la dimensione 1700x2400. Nella versione tonda la parte più scura è di 1/4 del tappeto. Dimensioni mm: rettangolare 1700x2400 2300x3000 - 3000x4000 quadrato 3000x3000 - rotondo Ø 2500.

Handmade with the handloom technique. Cotton weave, fleece in aloe and bamboo silk. Rectangular version 6" band in darker colour in the upper and lower side and 4" band for the size 67"x94 1/2". In the round version the darkest part is 1/4 of the carpet. Dimensions inches: rectangular 67"x94 1/2" 90 1/2"x118" - 118"x157 1/2" square 118"x118" - round Ø 94 1/2".



Tortora

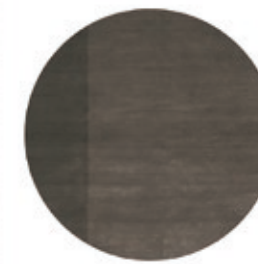

Cipria

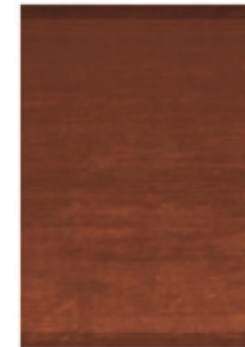
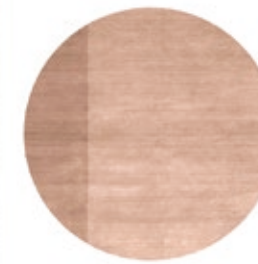

Ruggine



Arena

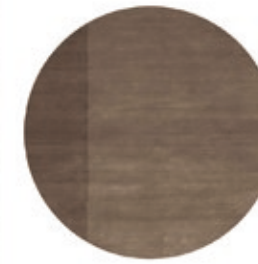

Natural



Nella pagina precedente: tappeto Plain tortora. In questa pagina: tappeto Plain natural.

Previous page: carpet Plain tortora. This page: carpet Plain natural.



SOFT



Dall'intreccio di venticinque diverse tonalità di grigio nasce il tappeto Soft, che si riconosce per le sfumature e l'aspetto cangiante dato dalla seta di bambù. Di forma rettangolare, Soft è un tappeto morbido e raffinato.

From the interweaving of twenty-five different shades of grey comes the Soft carpet, which distinguishes itself for the nuances and the iridescence given by the bamboo silk. Rectangular in shape, Soft is a soft and refined carpet.





## SOFT

Design R&D Poliform, 2015

Prodotto a mano con tecnica handloom.  
Trama in cotone, vello in seta di bambù  
grigio sfumato.  
Dimensioni mm: rettangolare 1700×2400  
2300×3000 - 3000×4000  
quadrato 3000×3000.

Handmade with the handloom technique.  
Cotton weave, fleece in bamboo silk shaded  
grey.  
Dimensions inches: rectangular 67"x94 1/2"  
90 1/2"x118" - 118"x157 1/2"  
square 118"x118".







# DAMA



Dama si riconosce per il motivo a scacchi, un pattern capace di dare un tocco vivace ma elegante a qualsiasi ambiente. La trama è in cotone, mentre nel vello s'intrecciano lana himalayana in tonalità natural e seta di bambù nera.

Dama distinguishes itself for its chequered pattern, capable of giving a lively yet elegant touch to any environment. The weave is made of cotton, while the fur is a blend of Himalayan wool in natural hues and black bamboo silk.







## DAMA

Design R&D Poliform, 2015

Prodotto a mano con tecnica handloom.  
Trama in cotone, vello in lana himalayana e  
seta di bambù.  
Dimensioni mm: rettangolare 1100×3500  
1700×2400 - 2300×3000 - 3000×4000  
quadrato 3000×3000.

Handmade with the handloom technique.  
Cotton weave, fleece in Hymalayan wool and  
bamboo silk.  
Dimensions inches: rectangular 43 1/4"x137  
1/4" - 67"x94 1/2" - 90 1/2"x118" - 118"x157  
1/2" square 118"x118".





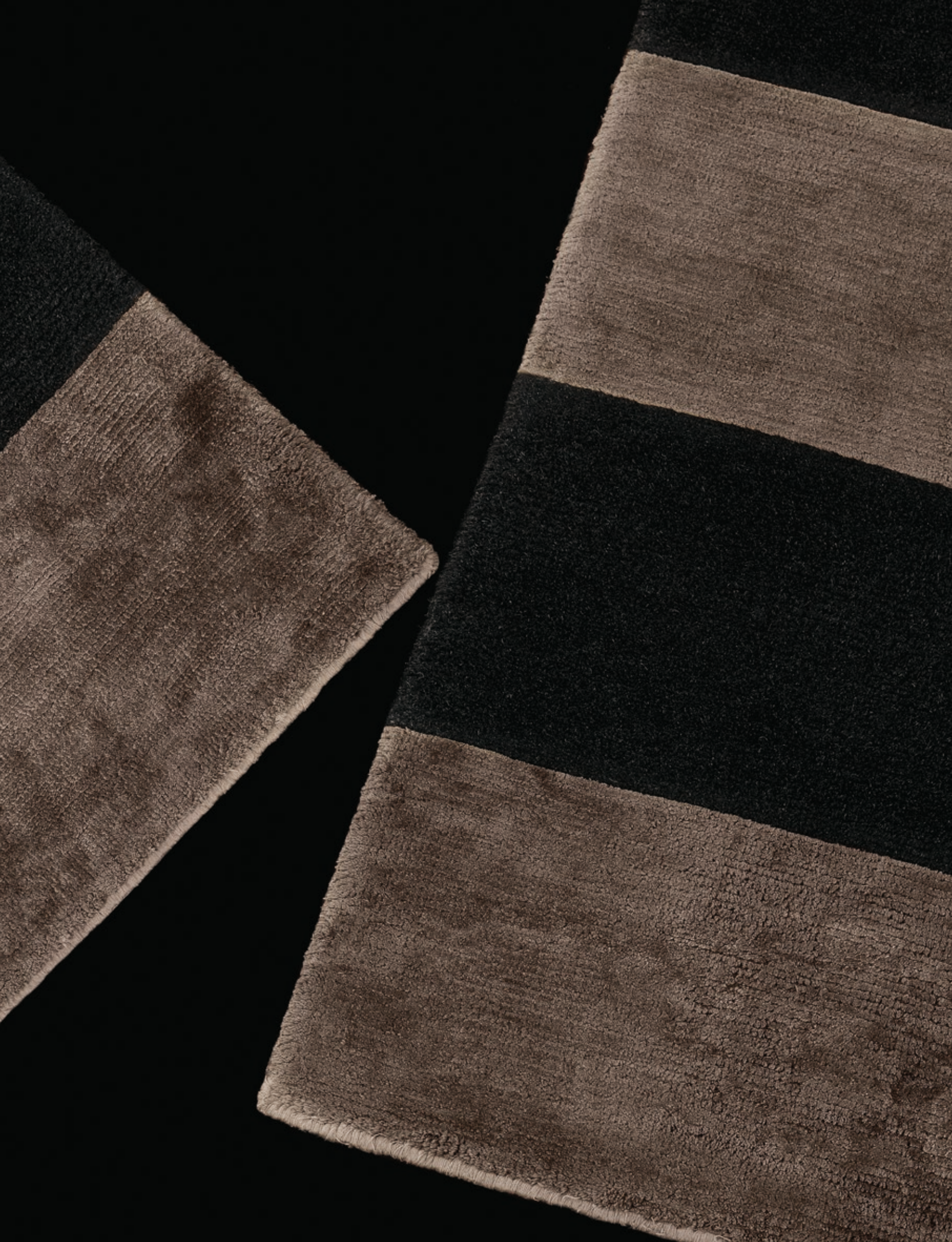

# STRIPES



Stripes è un tappeto a righe, un classico della nostra collezione. Le righe nere sono in seta di bambù, mentre quelle in tonalità natural sono in lana himalayana.

Stripes is a striped carpet, a classic of our collection. The black lines are made of bamboo silk, while the ones in natural shades are made of Himalayan wool.





## STRIPES

Design R&D Poliform, 2015

Prodotto a mano con tecnica handloom.  
Trama in cotone, vello in lana himalayana e  
seta di bambù.  
Dimensioni mm: rettangolare 1100×3500  
1700×2400 - 2300×3000 - 3000×4000  
quadrato 3000×3000.

Handmade with the handloom technique.  
Cotton weave, fleece in Hymalayan wool and  
bamboo silk.  
Dimensions inches: rectangular 43 1/4"x137  
1/4" - 67"x94 1/2" - 90 1/2"x118" - 118"x157  
1/2" square 118"x118".





TECHNICAL DATA

FINITURE  
FINISHINGS

302

INDICE PRODOTTI  
PRODUCT INDEX

310

FINITURE  
FINISHINGS

**Laccato opaco**  
**Mat lacquer**



82 glacier white



01 bianco



35 canapa



26 corda



88 castoro



46 tortora



64 arena



89 roccia



48 visone



49 moka



04 grafite



91 carbone



60 ghiaccio



09 pioggia



78 ferro



83 ocra



85 caramello



67 muschio



92 vischio



87 granata



86 danubio



70 prussia



77 champagne



24 ottone



23 bronzo

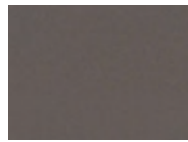

90 piombo



02 ardesia

**Laccato lucido**  
**Glossy lacquer**



82 glacier white

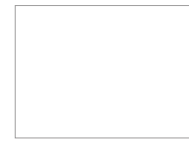

01 bianco



35 canapa



26 corda



46 tortora



60 ghiaccio



48 visone



49 moka



83 ocra



85 caramello



87 granata

**Laccato antigraffio**  
**Antiscratch lacquer**



01 bianco

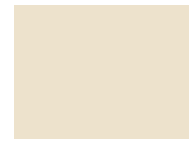

35 canapa



04 grafite



91 carbone

**Laccato metallico**  
**Metallic lacquer**



23 bronzo



24 ottone



25 titanio



FINITURE  
FINISHINGS

**Essenza  
Wood**



rovere gold  
gold oak



rovere spessart  
spessart oak



noce gold  
gold walnut



olmo nero  
black elm

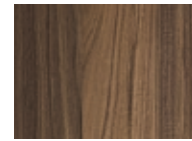

massello noce canaletto  
solid walnut canaletto



cedro  
cedar

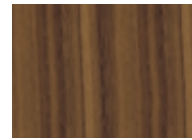

noce  
walnut

**Cuoio  
Hide**

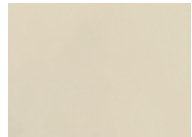

28 avorio



29 tortora

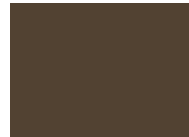

19 caffè



38 oliva

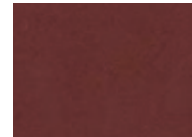

15 prugna



26 invecchiato



03 grigio scuro

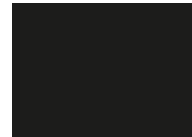

02 nero

**Tecnocover Grain  
Grain tecnocover**

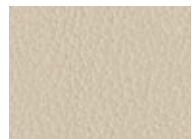

05 latte

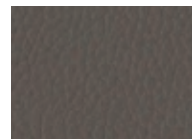

01 elefante



02 moro



06 nocciola

**Tessuto  
Fabric**

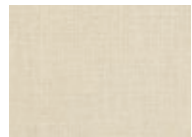

lino chiaro



lino é cru

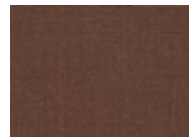

lino bruciato

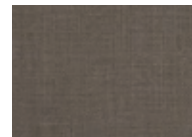

lino scuro

**Marmo levigato  
Mat marble**



bianco carrara



calacatta oro



verde lepanto

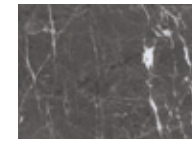

grigio stardust

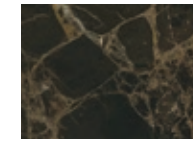

emperador dark

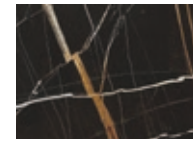

sahara noir  
finitura poliestere  
polyester finish



zecevo

**Marmo lucido  
Glossy marble**



bianco carrara



calacatta oro

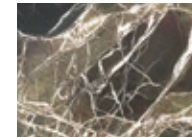

verde lepanto



grigio stardust

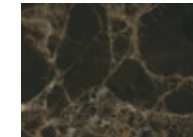

emperador dark

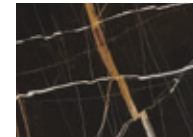

sahara noir  
finitura poliestere  
polyester finish



noir saint laurent

**Gabbro  
Gabbro**



nero assoluto  
texture juta

**Onice  
Onyx**



ambra  
amber

**Semiprezioso  
Semiprecious stone**



lapislazzulo blu  
blue lapis lazuli

**Pietra spatolata  
Spatula-finish stone**



ebano  
ebony

**Grès porcellanato lucido  
Glossy gres porcelain**

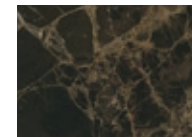

emperador dark



calacatta oro

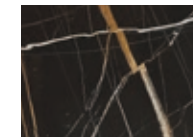

sahara noir

FINITURE  
FINISHINGS

**Tessuti  
Fabrics**

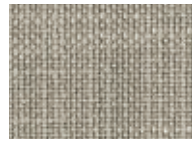

atlanta cat. b  
12 colori - colours



caleo cat. b  
15 colori - colours



chios cat. b  
13 colori - colours



eraclea cat. b  
12 colori - colours

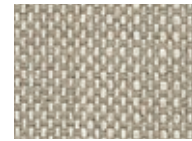

aspen cat. c  
12 colori - colours

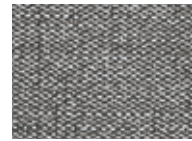

lima cat. c  
11 colori - colours

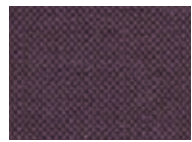

siviglia cat. c  
14 colori - colours



antea cat. d  
13 colori - colours



cordoba cat. d  
13 colori - colours



corinto cat. d  
5 colori - colours

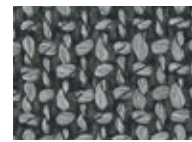

indra cat. d  
12 colori - colours



itaca cat. d  
10 colori - colours



kushiro cat. d  
13 colori - colours



lipsi cat. d  
11 colori - colours



micene cat. d  
9 colori - colours



milos cat. d  
5 colori - colours

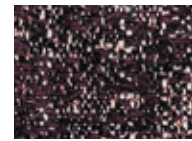

olimpia cat. d  
14 colori - colours



oxford cat. d  
8 colori - colours



rabat cat. d  
10 colori - colours

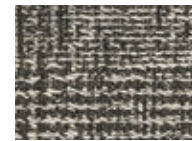

sendai cat. d  
5 colori - colours



sparta cat. d  
12 colori - colours



agadir cat. e  
9 colori - colours



arcadia cat. e  
12 colori - colours



argo cat. e  
13 colori - colours



hannover cat. e  
11 colori - colours



kitami cat. e  
12 colori - colours



naxos cat. e  
11 colori - colours



nayoro cat. e  
10 colori - colours

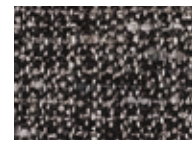

orleans cat. e  
10 colori - colours



persia cat. e  
16 colori - colours

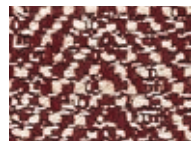

skyros cat. e  
12 colori - colours

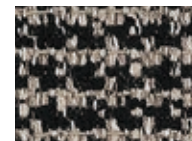

zante cat. e  
11 colori - colours



brest cat. g  
10 colori - colours



dundee cat. g  
6 colori - colours

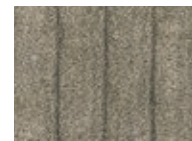

glasgow cat. g  
6 colori - colours



lero cat. g  
2 colori - colours



nancy cat. g  
6 colori - colours



norwich cat. g  
8 colori - colours



sheffield cat. g  
9 colori - colours



siro cat. g  
4 colori - colours



tebe cat. g  
11 colori - colours

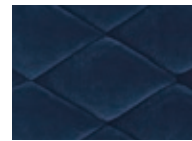

gibson cat. z  
6 colori - colours

**Pelle  
Leather**



spring cat. p  
13 colori - colours



colors cat. s  
25 colori - colours



silk cat. s  
13 colori - colours



silk intrecciata cat. s  
woven leather silk  
13 colori - colours



deep cat. x  
10 colori - colours



special cat. x  
21 colori - colours



nabuk cat. y  
10 colori - colours



nabuk intrecciata cat. y  
woven leather nabuk  
10 colori - colours

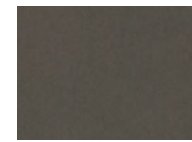

invecchiata cat. y  
6 colori - colours



soft cat. y  
14 colori - colours

**Pelliccia Cashmere  
Cashmere fur**



bianco

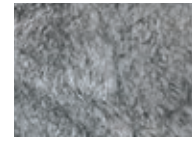

grigio



nero



bianco/nero



cappuccino



nero

**Pelle Hairy  
Hairy leather**

**Tecnocover Pixel  
Pixel tecnocover**

**Bordura gros-grain - bordura in seta - filati  
Grosgrain border - silk border - yarns**



burro



perla



sahara



rubino



tempesta  
escluso bordura in seta  
except silk border



navy

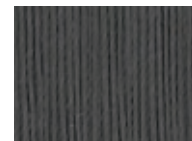

acciaio



nero

**Provence coordinati letto  
Bed linen Provence**

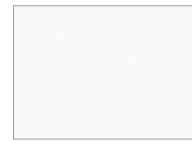

01 bianco



02 panna



08 polvere



04 tortora



06 roccia



07 grafite



03 ghiaccio



FINITURE  
FINISHINGS

**Vetro  
Glass**



1000 trasparente  
transparent



2000 trasparente  
extrachiaro-transparent  
extralight



3051 bronzato  
bronzed



3050 fumé



2700 line

**Vetro riflettente  
Reflecting glass**

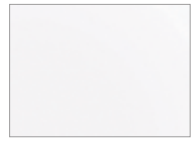

5000 trasparente  
transparent

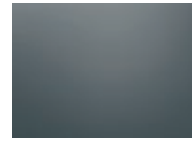

5010 blu



5051 bronzato  
bronzed



5059 fumé

**Vetro acidato  
Etched glass**



5380 acciaio



5323 bronzo



5325 titanio



**Specchio  
Mirror**

4000 bianco  
white



4051 bronzato  
bronzed

**Vetro satinato  
Mat glass**

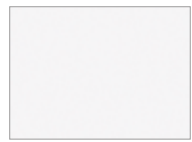

2301 bianco extrachiaro  
extralight bianco

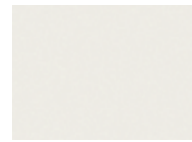

2373 ghiaccio  
ghiaccio

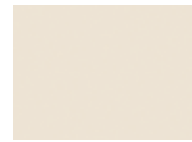

1335 canapa



1364 arena



1304 grafite



1303 nero

**Vetro lucido  
Glossy glass**

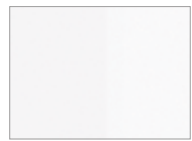

2201 bianco extrachiaro  
extralight bianco



2273 ghiaccio



1235 canapa



1264 arena



1204 grafite



1203 nero



1259 bordeaux

**Nobilitato  
Melamine**



olmo  
elm

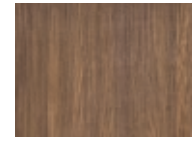

noce c.  
walnut c.



rovere cenere  
cenere oak

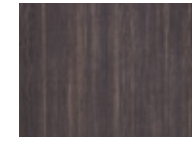

rovere spessart  
spessart oak



canvas beige



canvas grigio



graffiti 01 bianco



graffiti 35 canapa



graffiti 60 ghiaccio



silk canapa

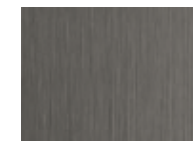

silk grey

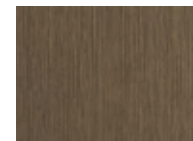

silk bronzo



club 01 bianco



skin  
27 colori laccato opaco  
27 mat lacquered colours



skin 94 latte  
laccato opaco  
mat lacquered

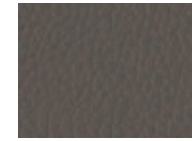

skin 97 elefante  
laccato opaco  
mat lacquered



skin 93 moro  
laccato opaco  
mat lacquered



skin 98 nocciola  
laccato opaco  
mat lacquered

**Nobilitato interno cassetti  
Melamine drawers structure**



ardesia



madras  
Quid sistema giorno -  
day system



roller latte



roller ardesia

**Metacrilato  
Methacrylate**

**Parti metalliche  
Metal parts**



brown nickel opaco  
mat brown nickel



brown nickel lucido  
glossy brown nickel



brown nickel satinato  
brushed brown nickel



champagne opaco  
mat champagne



champagne satinato  
brushed champagne



ardesia opaco  
mat ardesia



cromo satinato  
brushed chrome



cromo nero  
black chrome



cromo nero satinato  
brushed black chrome



bronzato  
bronzed



bronzo antico  
antique bronze



brunito opaco  
mat brunito

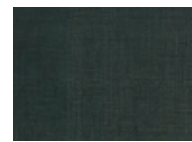

spatolato ferro  
spatula-finish ferro

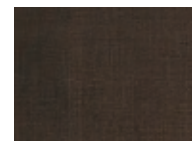

spatolato bronzo  
spatula-finish bronzo



oro lucido  
glossy gold



alluminio brill  
aluminium brill

TAVOLINI  
COFFEE TABLES



Koishi, design Jean-Marie Massaud  
pp. 10-25



Mondrian, design Jean-Marie Massaud  
pp. 26-41



Westside, design Jean-Marie Massaud  
pp. 42-57



Creek, design Jean-Marie Massaud  
pp. 58-71



Bristol System, design Jean-Marie Massaud  
pp. 72-81



Tribeca, design Jean-Marie Massaud  
pp. 82-91



Home Hotel, design Jean-Marie Massaud  
pp. 92-103



Henry, design Emmanuel Gallina  
pp. 104-113



Orbit, design Jean-Marie Massaud  
pp. 114-123



Nara, design Jean-Marie Massaud  
pp. 124-133



Soori, design Soo Chan  
pp. 134-143



Ilda, design Jean-Marie Massaud  
pp. 144-153



Dama, design R&D Poliform  
pp. 154-163



Baba, design Roberto Barbieri  
pp. 164-173



Flute, design Roberto Barbieri  
pp. 174-183



Paris Seoul, design Jean-Marie Massaud  
pp. 184-191

POUF  
POUFS



New York, design Jean-Marie Massaud  
pp. 196-207



Henry, design Emmanuel Gallina  
pp. 208-217



Play, design R&D Poliform  
pp. 218-227



Onda, design R&D Poliform  
pp. 228-237



Gant, design R&D Poliform  
pp. 238-247

TAPPETI  
CARPETS



Relief, design R&D Poliform  
pp. 252-257



Cannelé, design R&D Poliform  
pp. 258-263



Tratto, design R&D Poliform  
pp. 264-269

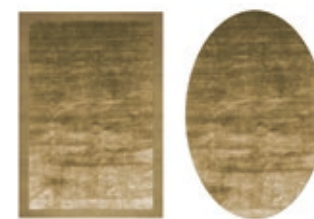

Frame, design R&D Poliform  
pp. 270-275



Plain, design R&D Poliform  
pp. 276-281



Soft, design R&D Poliform  
pp. 282-287



Dama, design R&D Poliform  
pp. 288-293



Stripes, design R&D Poliform  
pp. 294-299



**Poliform Spa**

via Montesanto 28  
Casella postale n. 1  
22044 Inverigo (CO) Italy  
t +39 031 6951  
f +39 031 699444  
info@poliform.it  
poliform.it



2018 Adi Compasso D'oro  
Career Award

**Poliform realizza tutte le sue collezioni in Italia usando componenti e materie prime selezionate.**

**All the Poliform collections are manufactured 100% in Italy using top-class components and materials.**

Poliform si riserva il diritto di apportare, senza preavviso, ogni modifica mirata al miglioramento funzionale e qualitativo dei propri prodotti. Testi e disegni presenti in questo stampato hanno scopo divulgativo: per ogni aspetto tecnico e dimensionale fare riferimento ai listini aziendali e relativi aggiornamenti. I campioni di colori e materiali hanno valore indicativo.

Poliform reserves the rights at all time to apply modifications for the functional or qualitative improvement of its products. Texts and drawings present in this brochure have a divulgative purpose: for every technical and dimensional aspect please refer to the company's price lists and their relative updates. The colour and material samples have an indicative value.

**Creative Direction**

Apartmento Studios

**Graphic Design**

Apartmento Studios

**Interiors Photography**

Federico Cedrone, Omar Sartor

**Still Life Photography**

Silvia Orlandi

**Interiors Styling**

Poliform Lab

1st edition January 2022

cod. 125/R1/2022



ASSARREDO  
FEDERLEGNOARREDO







POLIFORM.COM