

Poliform

ARTEX

KITCHENS

Poliform

ARTEX KITCHEN
DIGITAL CATALOGUE

Per la lavorazione sartoriale che ne contraddistingue l'anta, spesso abbinata a finiture preziose o nella versione a doghe, la cucina Artex è pensata per gli ambienti più esclusivi. Il progetto, firmato Poliform, è caratterizzato dalla particolare rastrematura eseguita sull'apertura, sul fianco e sul top, così da ottenere un incastro perfetto.

For the sartorial look that marks the door, often combined with precious finishes or in the slatted version, the Artex kitchen is designed for the most exclusive environments. The project, signed Poliform, is characterised by the particular tapering performed on the opening, on the side, and on the top, so as to obtain a perfect joint.





Qui e nelle pagine precedenti: basi con ante ed estrattori in acciaio scotch brite, top in pietra fossena fiammata. Cappa Factory a isola in acciaio scotch brite. Colonne centrali con ante in laccato goffrato visone, colonne ed elementi sopra colonna con ante vetrina PR21, telaio anodizzato moka e vetro riflettente fumé. Boiserie con pannelli in olmo nero e mensole in laccato goffrato carbone.

This and previous pages: base units with doors and pull-out storage baskets in scotch brite steel, top in fossena stone blaze. Factory island-hood in scotch brite steel. Central tall units with embossed lacquered visone doors, tall units and cabinets above tall units PR21 with moka anodized frame and fumé reflecting glass doors. Black elm wall panelling and embossed lacquered carbone shelves.





A sinistra: dettaglio dell'estrattore con cassetti verniciato brown, piattaja e attrezzatura interna in noce canaletto e alluminio anodizzato moka.

To the left: close-up of pull-out storage basket with drawers painted brown, plate holder and inner drawer equipment in walnut canaletto and moka anodized aluminium.





Qui e nelle pagine precedenti: basi con ante ed estrattori in acciaio scotch brite, top in pietra fossena fiammata. Cappa Factory a isola in acciaio scotch brite. Colonne centrali con ante in laccato goffrato visone, colonne ed elementi sopra colonna con ante vetrina PR21, telaio anodizzato moka e vetro riflettente fumé. Boiserie con pannelli in olmo nero e mensole in laccato goffrato carbone. Sotto: dettaglio del piano in pietra fossena fiammata con bordo rastremato e telaio di supporto in alluminio con finitura laccato goffrato carbone.

This and previous pages: base units with doors and pull-out storage baskets in scotch brite steel and top in fossena stone blaze. Factory island-hood in scotch brite steel. Central tall units with embossed lacquered visone doors, tall units and cabinets above tall unit PR21 with moka anodized frame and fumé reflecting glass doors. Black elm wall panelling and embossed lacquered carbone shelves. Below: close-up of top in fossena stone blaze with tapered edge and supporting frame in aluminium with embossed lacquered carbone finishing.





Nelle pagine precedenti: basi con ante ed estrattori in acciaio scotch brite e top in pietra fossena fiammata. Cappa Factory a isola in acciaio scotch brite. Colonne centrali con ante in laccato goffrato visone, colonne ed elementi sopra colonna con ante vetrina PR21, telaio anodizzato moka e vetro riflettente fumé. A destra: ante vetrina PR21 con telaio anodizzato moka e vetro riflettente fumé; negli elementi sopra colonna ante ad apertura tip-on. Sotto: dettaglio della maniglia integrata nel montante del telaio.

Previous pages: base units with doors and pull-out storage baskets in scotch brite steel and top in fossena stone blaze. Factory island-hood in scotch brite steel. Central tall units with embossed lacquered visone doors, tall units and cabinets above tall unit PR21 with moka anodized frame and fumé reflecting glass doors. To the right: glass tall units PR21 with doors in fumé reflecting glass and moka anodized frame; in the elements above tall unit doors with tip-on opening. Below: close-up of handle integrated into frame upright.



A destra: dettaglio delle colonne con ante vetrina PR21, telaio anodizzato moka e vetro riflettente fumé. Ripiani interni in vetro con telaio anodizzato nero e cassettiere in olmo nero con sagome laccato opaco moka. Sotto: dettaglio della cassetiera con attrezzatura in noce canaletto e alluminio anodizzato moka.

To the right: close-up of tall units with doors PR21 with moka anodized frame and fumé reflecting glass doors. Glass inner shelves with black anodized frame and chest of drawers in black elm with profile in moka mat lacquered. Below: close-up of inner chest of drawers with equipment in walnut canaletto and moka anodized aluminium.





Qui e nelle pagine precedenti: basi con ante ed estrattori in olmo nero a doghe e top in pietra fossena fiammata. Piano cottura in acciaio scotch brite a cinque fuochi e lavello in acciaio scotch brite personalizzati Poliform by Barazza. Cappa Factory a isola in acciaio scotch brite.

This and previous pages: base units with doors and pull-out storage baskets in black elm with carved lines and top in fossena stone blaze. Personalized five burners scotch brite steel hob and sink Poliform by Barazza. Factory island-hood in scotch brite steel.



ARTEX

Design R&D Poliform

Basi p 1280

Strutture: nobilitato grigio lavagna.
Ante ed estrattori: acciaio scotch brite.
Top: pietra fossena fiammata spessore 20 mm con bordo rastremato e telaio di supporto in alluminio laccato goffrato carbone.
Zoccoli: laccato goffrato carbone.

Colonne vetrina PR21 p 640

Strutture: nobilitato grigio lavagna.
Ante: telaio anodizzato moka e vetro riflettente fumé.
Ripiani interni: vetro e telaio anodizzato nero.
Cassettiere interne: olmo nero con sagome laccato opaco moka.
Zoccoli: laccato goffrato carbone.

Colonne parte centrale

Ante e sagome orizzontali: laccato goffrato visone.

Elementi sopracolonna vetrina PR21

Ante: telaio anodizzato moka e vetro riflettente fumé.
Aperture: tip-on.
Ripiani interni: vetro con telaio anodizzato nero.

Boiserie

Pannelli: olmo nero.
Mensole: laccato goffrato carbone, spessore 3 mm.

Base units d 50 1/2"

Structures: grey lavagna melamine.
Doors and pull-out storage baskets: scotch brite steel.
Top: fossena stone blaze, thickness 3/4" with tapered edge and supporting frame in carbone embossed lacquered aluminium.
Plinths: embossed lacquered carbone.

Glass tall units PR21 d 25 1/4"

Structures: grey lavagna melamine.
Doors: anodized moka frame and fumé reflecting glass.
Inner shelves: glass with black anodized frame.
Inner chest of drawers: black elm with profile moka mat lacquered.
Plinths: embossed lacquered carbone.

Central tall units

Doors and horizontal profiles: embossed lacquered visone.

Cabinets above tall unit PR21

Doors: anodized moka frame and fumé reflecting glass.
Openings: tip-on.
Inner shelves: glass with black anodized frame.

Wall panelling

Panels: black elm.
Shelves: embossed lacquered carbone, thickness 1/8".

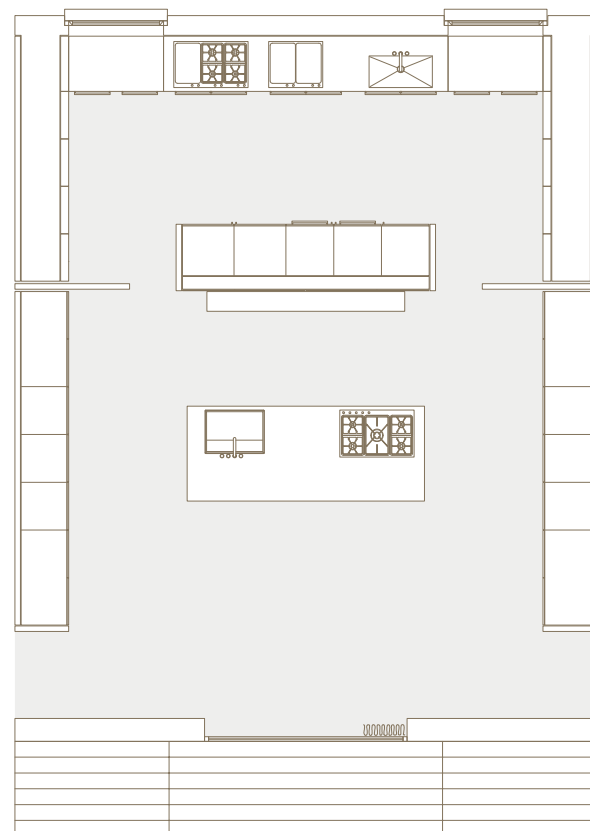
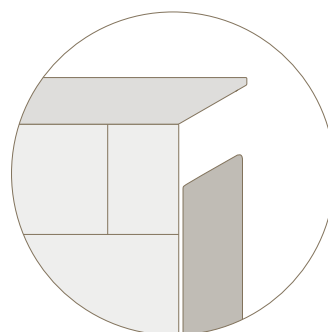

Basi Base units

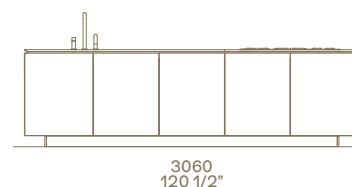
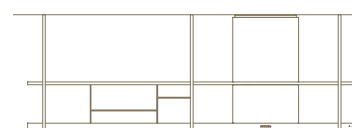

917
36"

3060
120 1/2"

Boiserie Wall panelling



3212
126 1/2"

2950
116 1/4"

Colonne Tall units

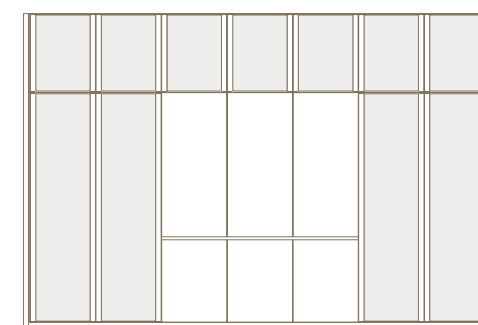

4200
165 1/4"

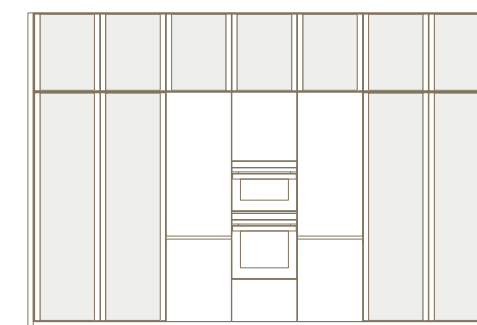

4200
165 1/4"

2950
116 1/4"

- 1 Piano cottura in acciaio scotch brite
5 fuochi personalizzato Poliform by
Barazza, incasso filotop.
- 2 Lavello in acciaio scotch brite
personalizzato Poliform by Barazza con
sportello copripiletta, incasso filotop.
- 3 Attrezzatura in noce canaletto e
alluminio anodizzato moka per cassetti
interni ed estrattori.

- 4 Cappa Factory a isola in acciaio scotch
brite.
- 5 Boiserie con pannelli in olmo nero.
- 6 Elementi sopra colonna vetrina PR21,
ante apertura tip-on.
- 7 Colonne vetrina PR21 con ante ad
apertura battente, ripiani interni e
cassettiere.

- 8 Colonne centrali con forni e frigo/
congelatore, con ante ad apertura
battente ed estrattori.
- 9 Attrezzatura in noce canaletto e
alluminio anodizzato moka per
cassettiera interna.

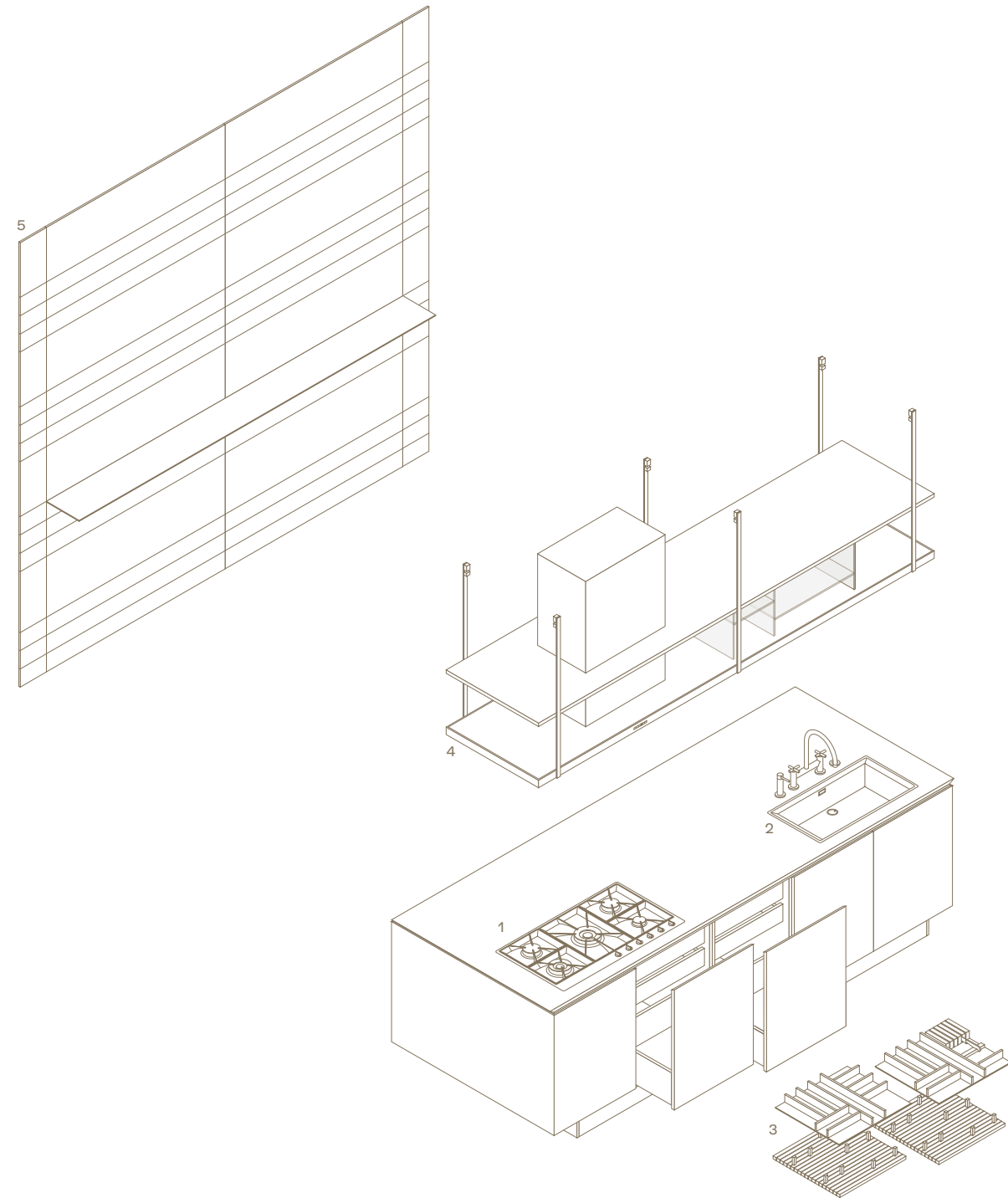

- 1 Personalized scotch brite steel hob with
5 burners Poliform by Barazza, flush
built-in.
- 2 Personalized scotch brite steel sink
Poliform by Barazza with drain cover,
flush built-in.
- 3 Equipment in walnut canaletto and moka
anodized aluminium for inner drawers
and pull-out storage baskets.

- 4 Factory island-hood in scotch brite
steel.
- 5 Wall panelling in black elm.
- 6 Elements above tall unit PR21, glass
doors with tip-on opening.
- 7 Glass tall units PR21 with leaf doors,
inner shelves and chest of drawers.

- 8 Central tall units with ovens, fridge and
freezer with leaf doors and pull-out
storage baskets.
- 9 Equipment in walnut canaletto and
moka anodized aluminium for inner
chest of drawers.

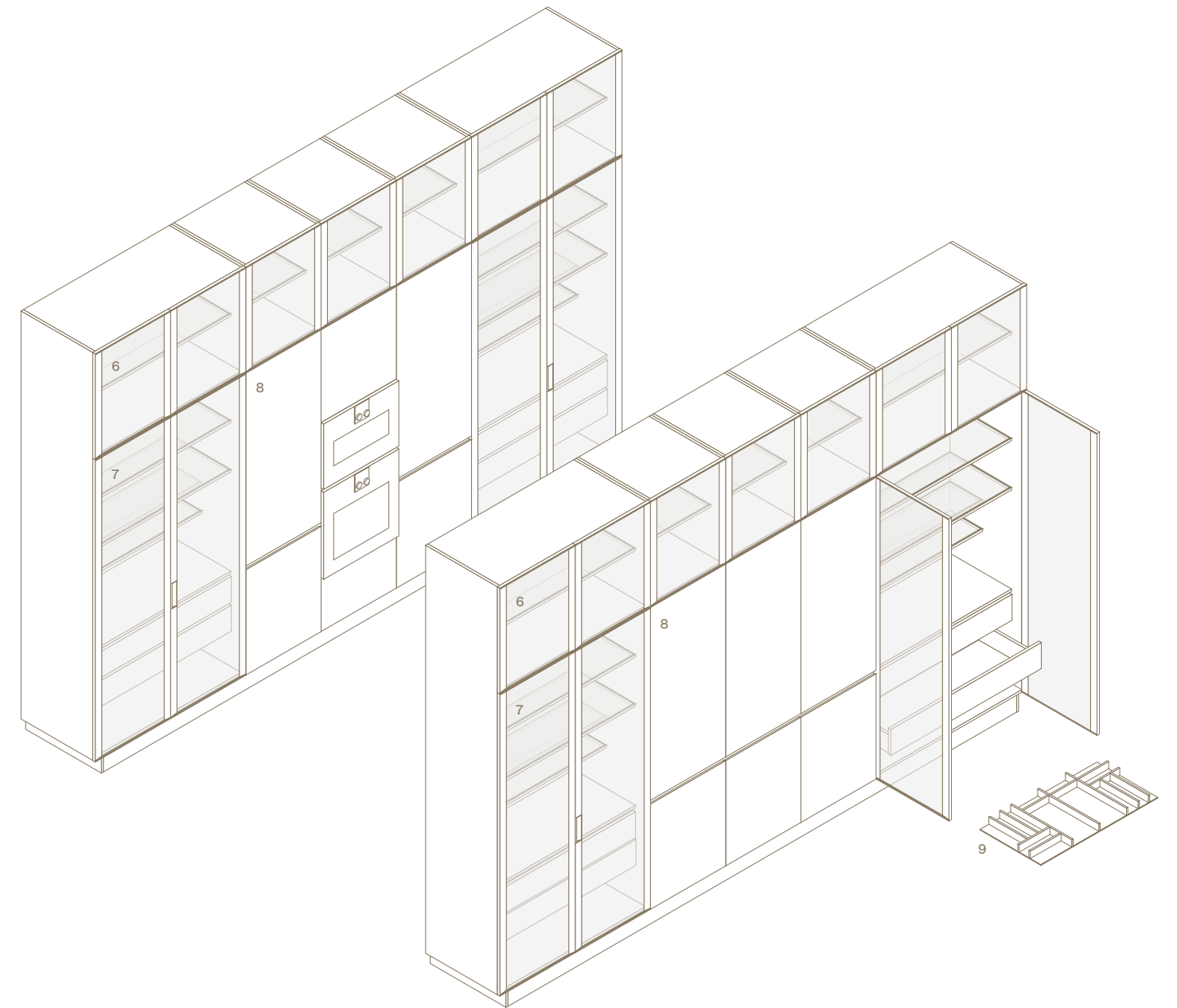

ARTEX
Design R&D Poliform

Anta a doghe
Spessore anta
26 mm.
Lato maniglia sagomato 60°.

Finiture anta
Laccato goffrato 23 colori.
7 essenze.
DuPont Corian® glacier white.

Door with carved lines
Door thickness
26 mm - 1".
Handle edge shaped to 60°.

Door finishings
Embossed lacquered 23 colours.
7 woods.
DuPont Corian® glacier white.

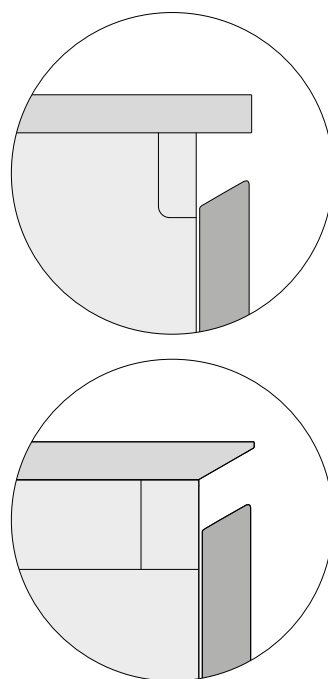

Anta liscia
Spessore anta
26 mm.
Lato maniglia sagomato 60°.

Finiture anta
Laminato opaco touch 6 colori.
Laminato opaco touch 6 colori.
Laccato lucido 18 colori.
Laccato goffrato 23 colori.
Laccato metallico 4 colori.
7 essenze.
Massello noce canaletto.
Massello rovere termico.
Massello rovere fossile.
Massello black ash.
DuPont Corian® glacier white.
Acciaio scotch brite.

Flat door
Door thickness
26 mm - 1".
Handle edge shaped to 60°.

Door finishings
Mat laminate 6 colours.
Mat laminate touch 6 colours.
Glossy lacquered 18 colours.
Embossed lacquered 23 colours.
Metallic lacquered 4 colours.
7 woods.
Solid walnut canaletto.
Solid thermic oak.
Solid fossil oak.
Solid black ash.
DuPont Corian® glacier white.
Steel scotch brite.

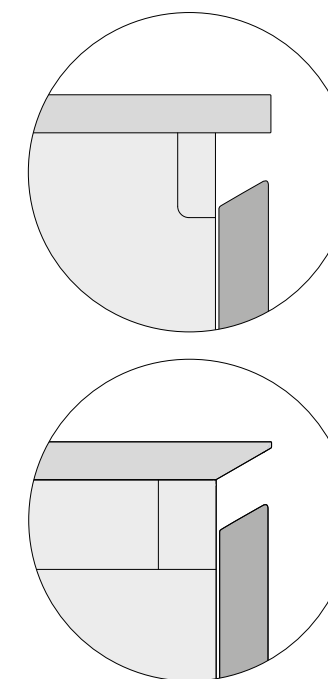

VETRINE SHOWCASES

PR19

Spessore 26 mm.
Anta in vetro riflettente 5051 bronzato
con telaio in alluminio verniciato bronzo.
Per pensili apertura con profilo inferiore
o apertura tip-on.
Thickness 26 mm - 1".
Door in bronzed reflecting glass 5051
with frame in bronzo painted aluminium.
For wall units with opening with lower
profile or tip-on opening.



PR22

Spessore 20 mm.
Anta in vetro riflettente 5059 fumé
con telaio alluminio anodizzato nero.
Per pensili apertura con profilo inferiore.
Per colonne apertura con distanziale
o con maniglia integrata verniciato nero.
Per elementi sopra colonna apertura
con distanziale o apertura tip-on.
Thickness 20 mm - 3/4".
Door in fumé reflecting glass 5059 with
black anodized aluminium frame.
For wall units with opening with lower profile.
For tall units with opening with spacer or
with black painted integrated handle.
For elements above tall unit with opening
with spacer or tip-on opening.



PR21

Spessore 26 mm.
Anta in vetro riflettente 5059 fumé
con telaio in alluminio anodizzato moka.
Per pensili apertura con profilo inferiore.
Per colonne apertura con maniglia
integrata verniciato moka.
Per elementi sopra colonna apertura tip-on.
Thickness 26 mm - 1".
Door in fumé reflecting glass 5059 with
moka anodized aluminium frame.
For wall units with opening with lower profile.
For tall units with opening moka painted
integrated handle.
For elements above tall unit with tip-on
opening.



ATTREZZATURA CASSETTI DRAWERS EQUIPMENTS

Tipologie

- 1 Cassetti.
- 2 Cassetti interni estraibile.
- 3 Cassetti interni anta.

Accessori

Portaposate, portacoltelli, bilancia elettronica, tagliere per pane, portaspezie in ceramica, vaschette in acciaio, set macinaspezie, portapelliole, portamattarello.

Types

- 1 Drawers.
- 2 Pull-out baskets.
- 3 Leaf door with inner drawers.

Accessories

Cutlery tray, knife-rack, electronic scale, chopping board for bread, ceramic spice-holder, steel basins, spice grinder set, protective-film rack, rolling pin-holder.

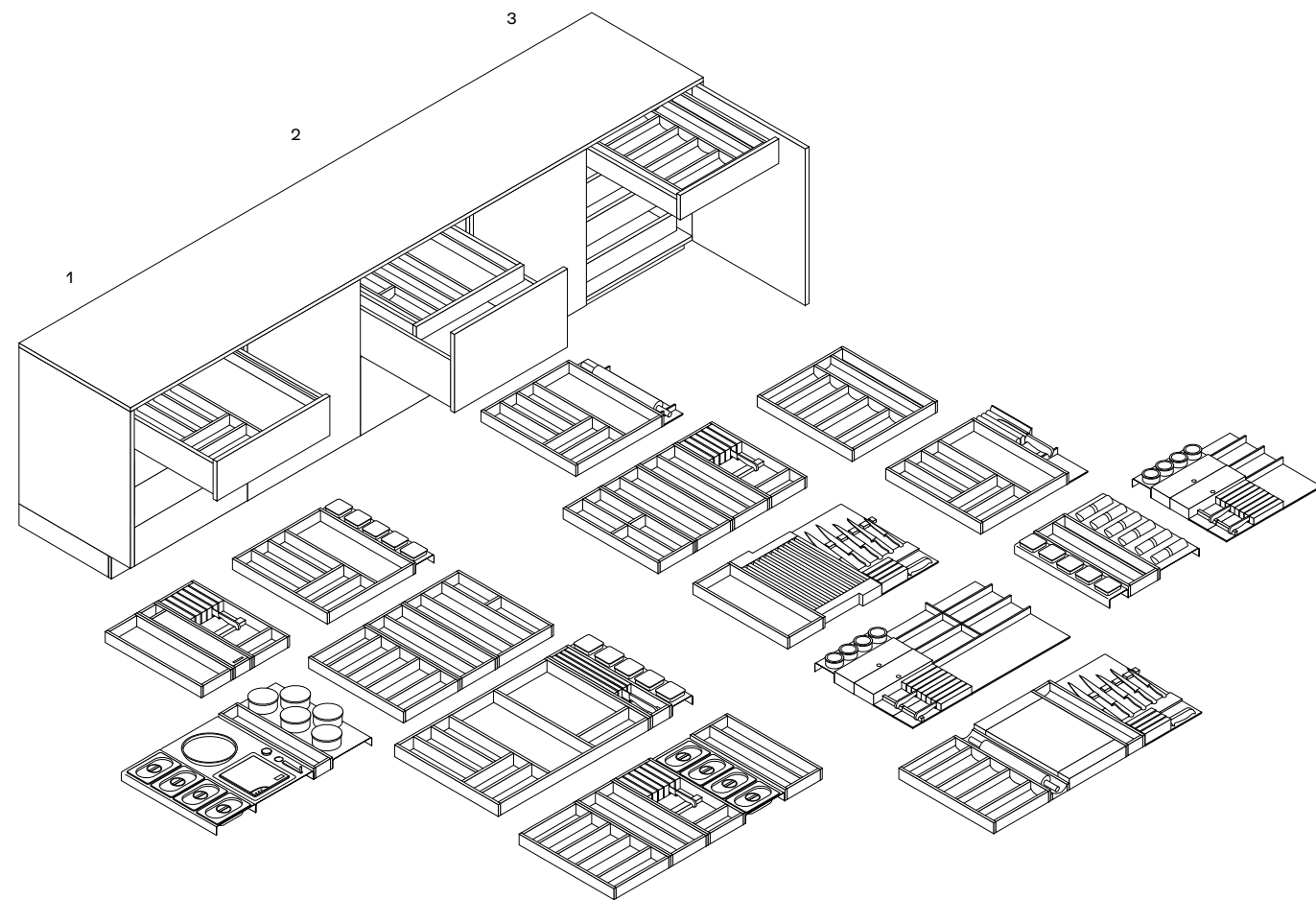

Attrezzature Equipments



Wengé
Wenge



Noce canaletto
Walnut canaletto



Laminato military touch
Laminate military touch



Alluminio
Aluminium



Materiale plastico
atossico antracite
Non-toxic plastic
colour antracite

ATTREZZATURA ESTRATTORI PULL-OUT BASKETS EQUIPMENTS

Tipologie

- 1 Base 1 estraibile e 2 cassetti.
- 2 Base 2 estraibili.
- 3 Base 1 estraibile unico e 1 estraibile interno.

Accessori

Piattaia, portapiatti regolabile, barattoli portapasta in acciaio, portapane in terracotta, portaspezie in ceramica, portarotolo, contenitori in ceramica, contenitori in acciaio.

Types

- 1 Base unit 1 pull-out basket and 2 drawers.
- 2 Base unit 2 pull-out baskets.
- 3 Base unit 1 pull-out basket and 1 inner pull-out basket.

Accessories

Plate-rack, adjustable plate-rack, kit pasta-holders in steel, clay bread container, ceramic spice-holder, rolling pin-holder, ceramic holders, steel holders.

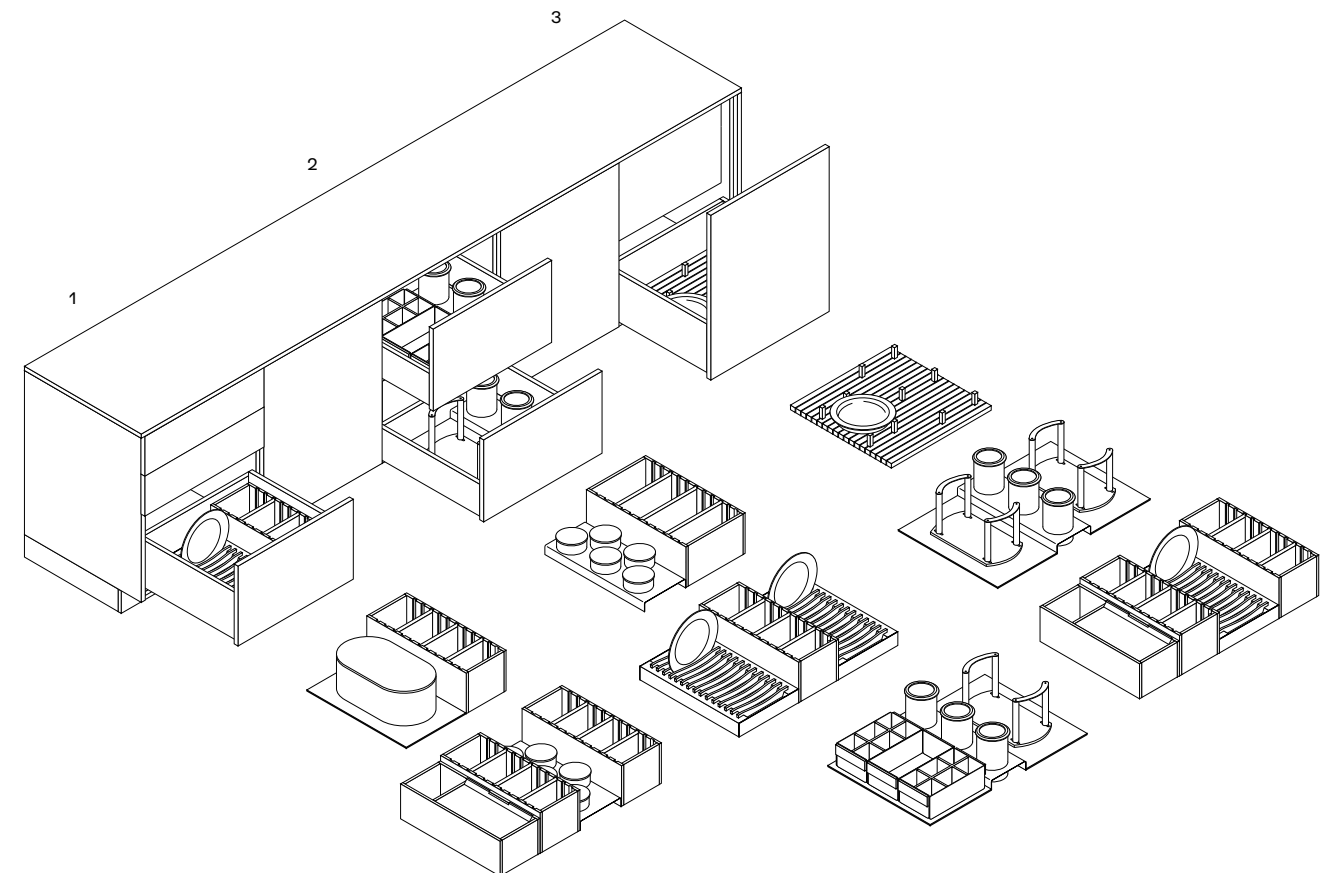

Attrezzature Equipments

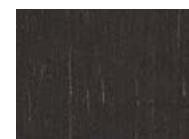

Wengé
Wenge



Noce canaletto
Walnut canaletto



Laminato military touch
Laminate military touch



Alluminio
Aluminium

COLONNE ATTREZZATE EQUIPPED TALL UNITS

Tipologie

- 1 Colonna con struttura estraibile Tandem.
- 2 Colonna con struttura estraibile Convoy Lavido.
- 3 Colonna con struttura estraibile Convoy Centro.
- 4 Colonna attrezzata con ganci portascoppe e cestelli.

Types

- 1 Tall unit with Tandem extractable equipment.
- 2 Tall unit with Convoy Lavido extractable equipment.
- 3 Tall unit with Convoy Centro extractable equipment.
- 4 Tall unit with broom-holders and storage baskets.

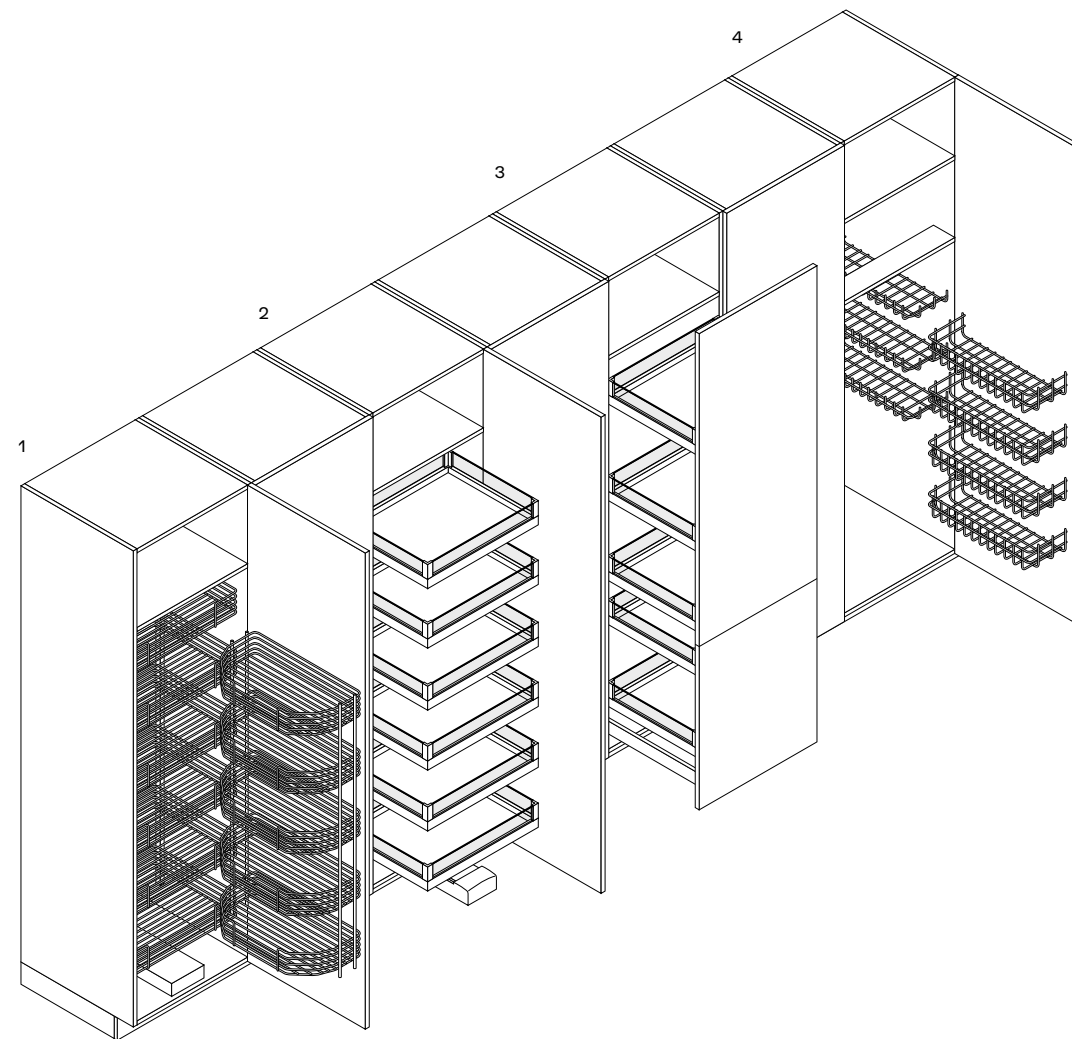

VANI ATTREZZATI EQUIPPED UNITS

Tipologie

- 1 Ante battenti apertura totale.
- 2 Ante a scomparsa.

Attrezzature

Piano di lavoro estraibile in acciaio o essenza, barra con lampade e presa elettrica, cassetti interni, ripiani, ripiani in vetro, Shaker e Deep Shaker, luce led.

Types

- 1 Total opening leaf door.
- 2 Pocket doors.

Equipments

Extractable worktop in steel or woods, light cover bar with lamp and socket, internal drawers, shelves, shelves in glass, Shaker and Deep Shaker, led lighting.

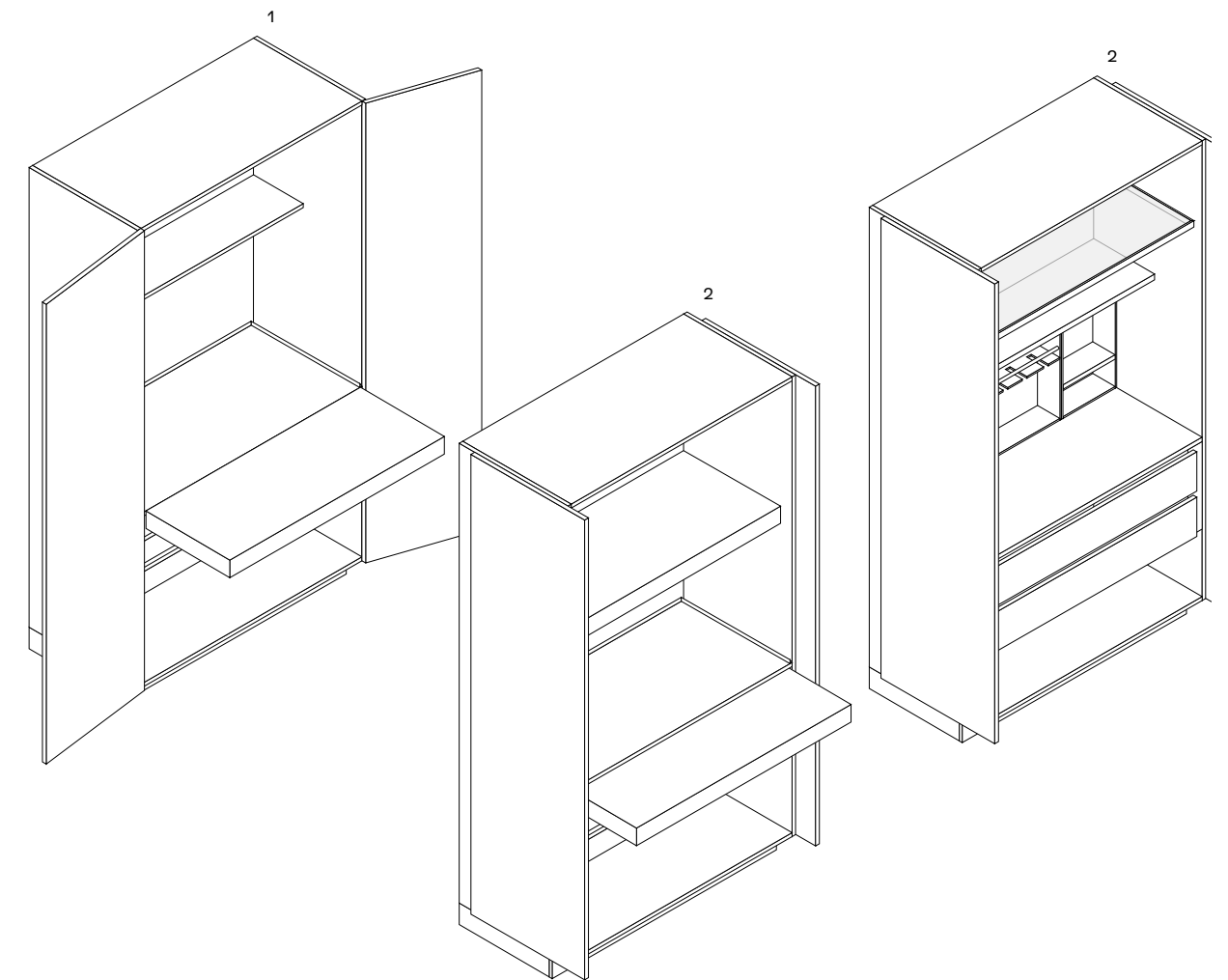

COLONNE CON VANI A GIORNO
OPEN TALL UNITS

Tipologie

- 1 Colonna a giorno con ripiani.
- 2 Colonna a giorno con cestelli in midollino.
- 3 Colonna a giorno Trail.

Types

- 1 Open tall unit with shelves.
- 2 Open tall unit with wicker baskets.
- 3 Trail open tall unit.

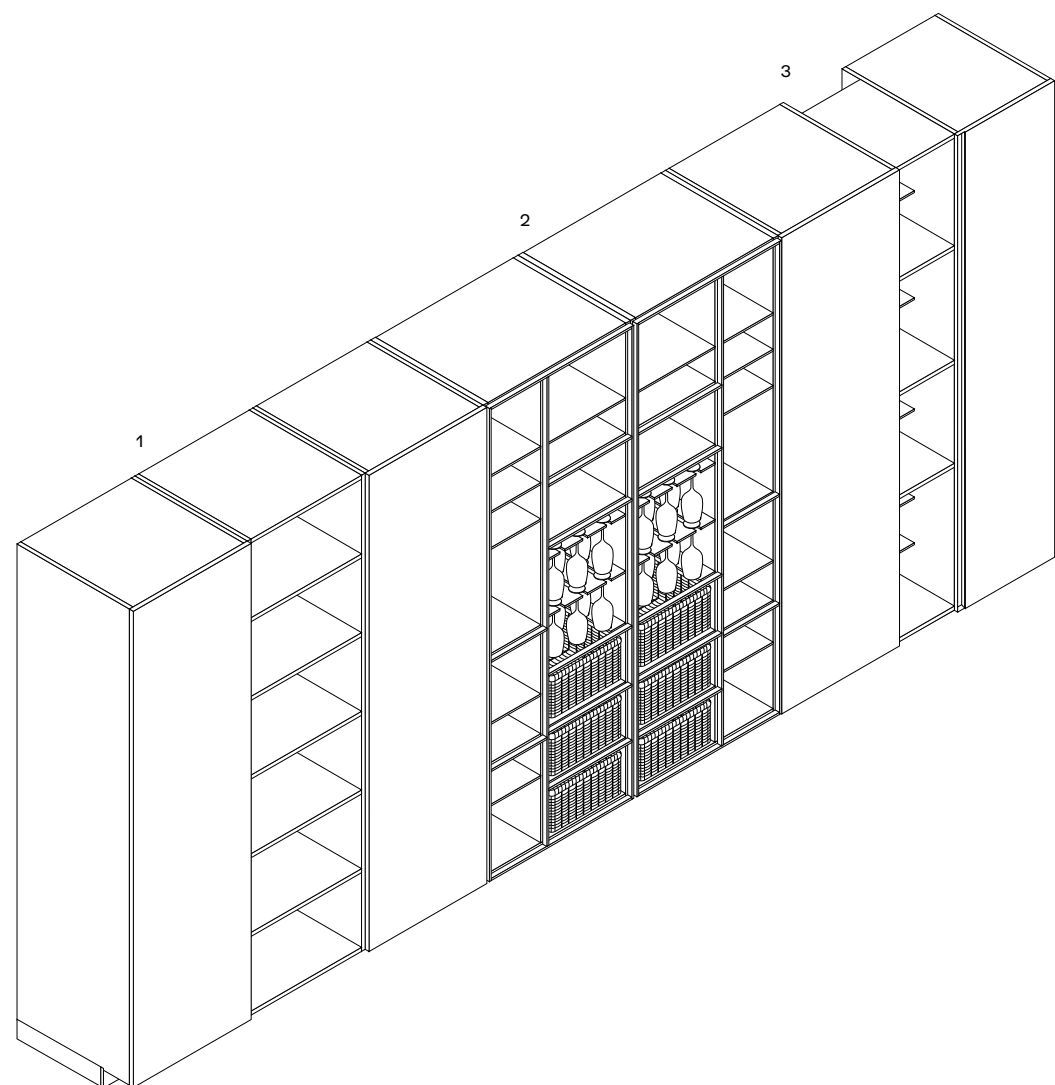

DEEP SHAKER E SHAKER SCHIENALI MODULARI
DEEP SHAKER AND SHAKER MODULAR BACKS

Deep Shaker - profondità 160
Shaker - profondità 120

Schienali modulari disponibili in diverse dimensioni e configurazioni. Moduli larghezza da 300 a 1200.

- 1 Moduli sopratop, misure variabili in riferimento allo spessore del top. Moduli Shaker h 600. Moduli Deep Shaker h 600-720-840.
- 2 Moduli a terra, Shaker e Deep Shaker h 1380-1440.

Deep Shaker attrezzature

Ripiani, tubi, contenitori in DuPont Corian®, porta spezie, porta coltelli, porta tablet, griglia, porta bicchieri, cassettoni in noce canalotto, barattoli in ceramica o in vetro, canalina elettrificata. Anta a ribalta con porta spezie, barattoli in ceramica o attrezzatura elettrica.

Shaker attrezzature

Ripiani, tubi, contenitori in DuPont Corian®, griglia, porta bicchieri.

Deep Shaker - depth 6 1/4"
Shaker - depth 4 3/4"

Modular backs available in different sizes and configurations. Modules width from 11 3/4" to 47 1/4".

- 1 Module above worktop, sizes according to the worktop thickness. Shaker modules h 23 1/2". Deep Shaker modules h 23 1/2"-28 1/4"-33".
- 2 Floorstanding modules, Shaker and Deep Shaker h 54 1/4"-56 3/4".

Deep Shaker accessories

Shelves, bars, containers in DuPont Corian®, spice holders, knife-rack, tablet holder, little drawers in walnut canaletto, ceramic or glass jars, powered conduit. Flap door with spices holder, ceramic jars or electric accessories.

Shaker accessories

Shelves, bars, containers in DuPont Corian®, grid, glass holders.

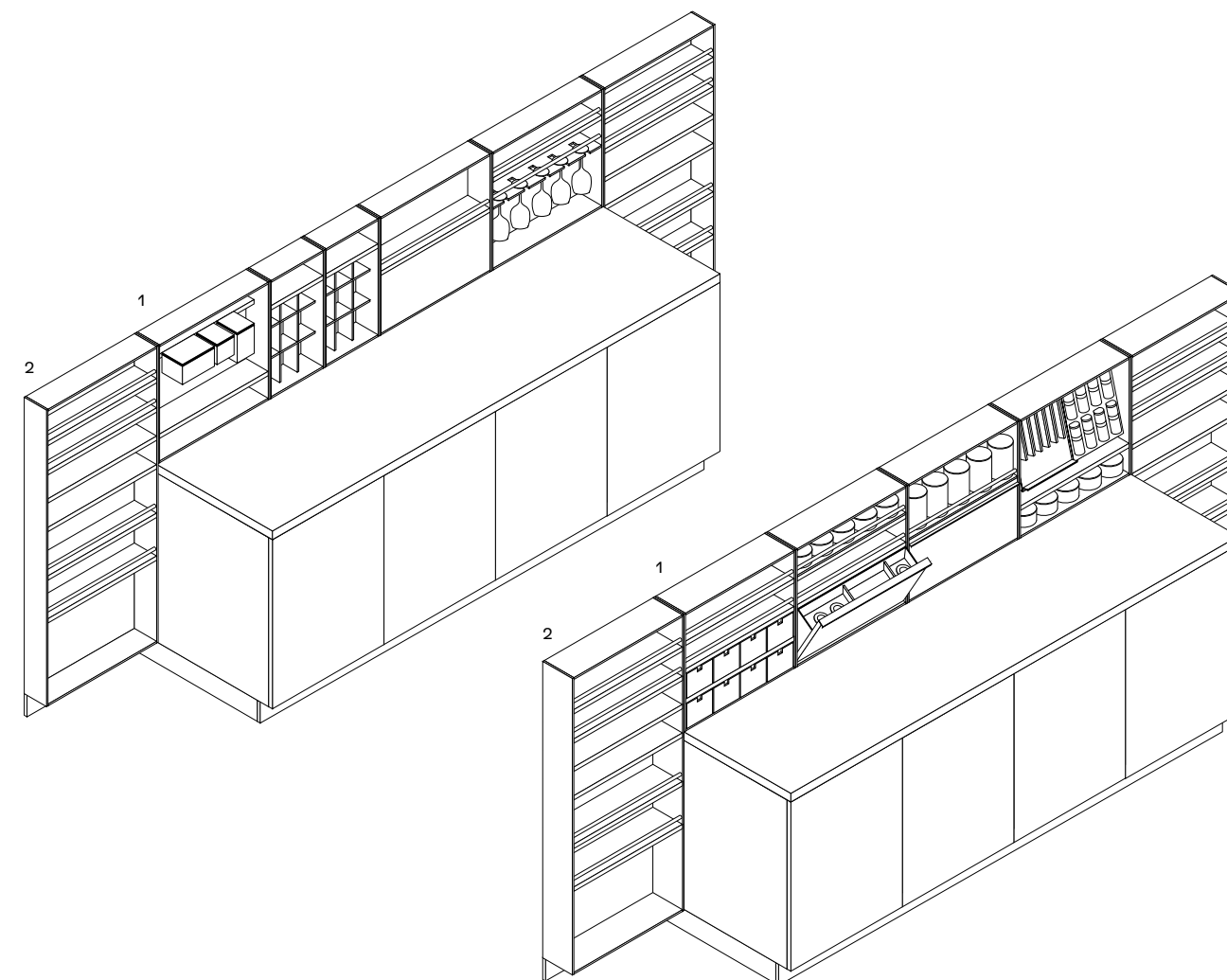

SOLUZIONI PER ANGOLI CORNER SOLUTIONS

Basi

- 1 Base doppio battente.
- 2 Base anta battente.

Pensili

- 3 Pensile anta battente.
- 4 Pensile anta pieghevole.
- 5 Pensile doppio battente.

Colonne

- 6 Colonna doppio battente.
- 7 Colonna anta battente.

Attrezzature

- 8 Cesti estraibili LeMans.
- 9 Cestelli in metallo cromato.

Base units

- 1 Base unit with two leaf doors.
- 2 Base unit with leaf door.

Wall units

- 3 Wall unit with leaf door.
- 4 Wall unit with folding door.
- 5 Wall unit with two leaf doors.

Tall units

- 6 Tall unit with two leaf doors.
- 7 Tall unit with leaf door and inner shelves.

Equipments

- 8 Pull-out storage baskets LeMans.
- 9 Baskets in chromed metal.

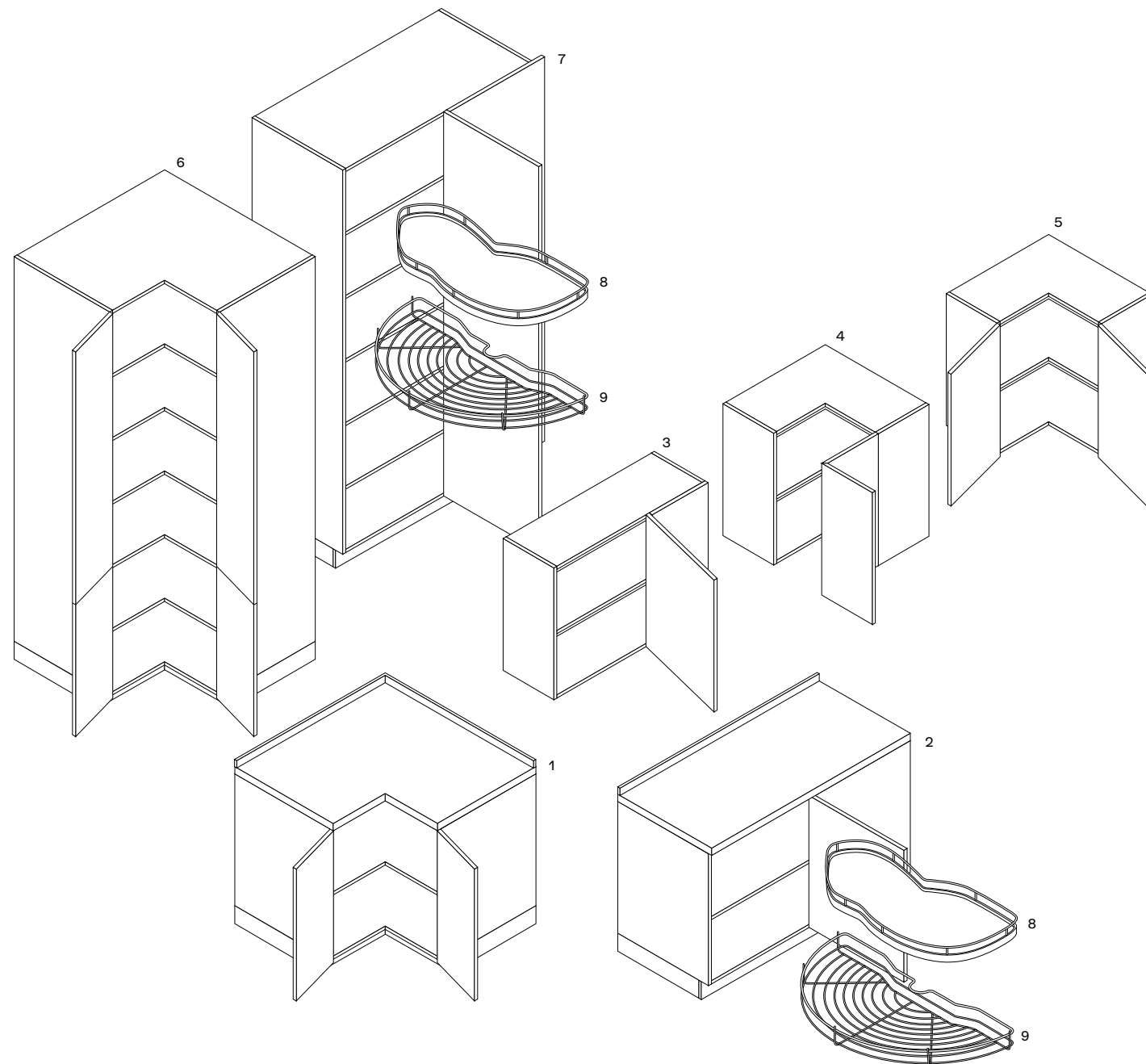

COLONNE HIGH HIGH TALL UNITS

Il sistema colonne High, disponibile per i modelli Shape, Artex, Phoenix e Trail, prevede la sovrapposizione di singoli fusti e il montaggio di un'anta intera o di due ante divise. Nel caso di ante divise, il taglio delle ante è situato sempre nella parte inferiore, a 840 mm dal filo inferiore della colonna. Lo zoccolo previsto è di 70 o 100 mm. Anta intera non disponibile nella versione in massello.

- 1 Colonna anta intera
h 2710-2740, anta h 2640
h 2830-2860, anta h 2760.
- 2 Colonna anta intera a scomparsa
h 2710-2740, anta h 2640.
- 3 Colonna con ante divise
h 2710-2740, ante h 840+1800
h 2830-2860, ante h 840+1920
h 2950-2980, ante h 840+2040.

The tall unit system High, available for the models Shape, Artex, Phoenix and trail, consists of two superimposed elements and a full height door or two separate doors. In case of separate doors, the separation of the doors is always in the lower part, 33" from the lower edge of the tall unit. The plinth is foreseen in h 3/4" or 4". The full height door is not available in solid wood finish.

- 1 Tall unit with full height door
h 106 3/4"-107 3/4", door h 104"
h 111 1/2"-112 1/2", door h 108 3/4".
- 2 Tall unit with full height pocket door
h 106 3/4"-107 3/4", door h 104".
- 3 Tall unit with separate doors
h 106 3/4"-107 3/4", doors h 33"+70 3/4"
h 111 1/2"-112 1/2", doors h 33"+75 1/2"
h 116 1/4"-117 1/4", doors h 33"+80 1/4".

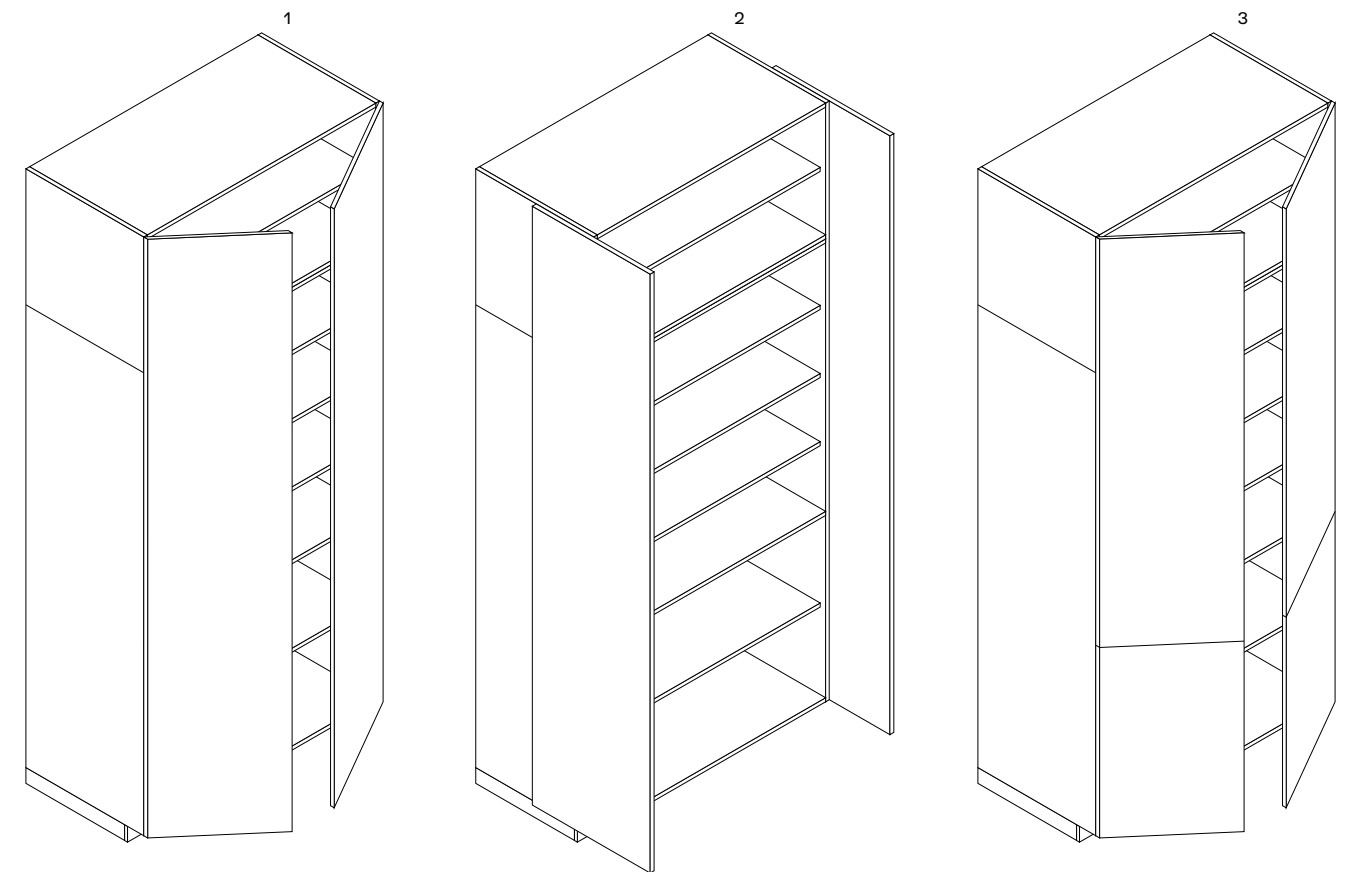

PIANI COTTURA HOBS

Tipologie

- 1 Piano a gas.
- 2 Piano a induzione.
- 3 Elementi modulari.

Tipologie di incasso

Incasso standard: il piano sporge da 4 a 15 mm; semifilotop: bordo inclinato di 3 mm; finotop: il piano sporge 1 mm; filotop. Nel caso di piani di lavoro in acciaio, i piani cottura possono essere saldati direttamente nella superficie del top.

Types

- 1 Gas hob.
- 2 Induction hob.
- 3 Modular elements.

Built-in types

Standard built-in with jutting hob of 1/4" a 1/2"; semi-flush built-in with inclined edge of 1/8"; flush built-in with jutting hob 5/128" and fully flush built-in. In case of steel worktops, the hobs can be soldered directly in the worktop.

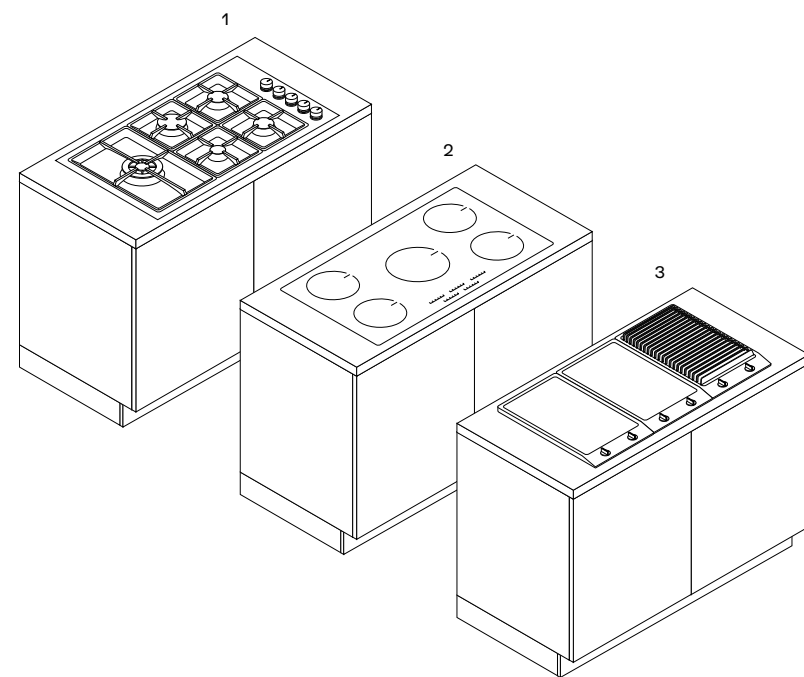

Tipologie di incasso Built-in types

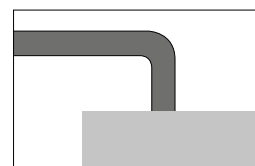

Standard
Standard built-in

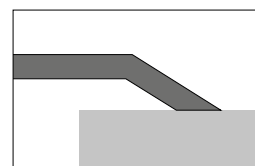

Semifilotop
Semi-flush built-in

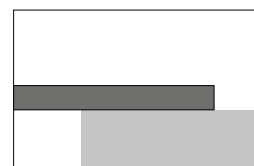

Finotop
Flush built-in

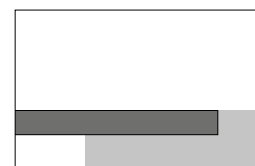

Filotop
Fully flush built-in

LAVELLI SINKS

Tipologie

- 1 Vasca singola.
- 2 Vasca e gocciolatoio.
- 3 Vasca grande e piccola.
- 4 Vasca grande, piccola e gocciolatoio.
- 5 Due vasche.
- 6 Due vasche e gocciolatoio.

Types

- 1 Single basin.
- 2 Basin with drip.
- 3 Big and small basins.
- 4 Big and small basins with drip.
- 5 Two basins.
- 6 Two basins with drip.

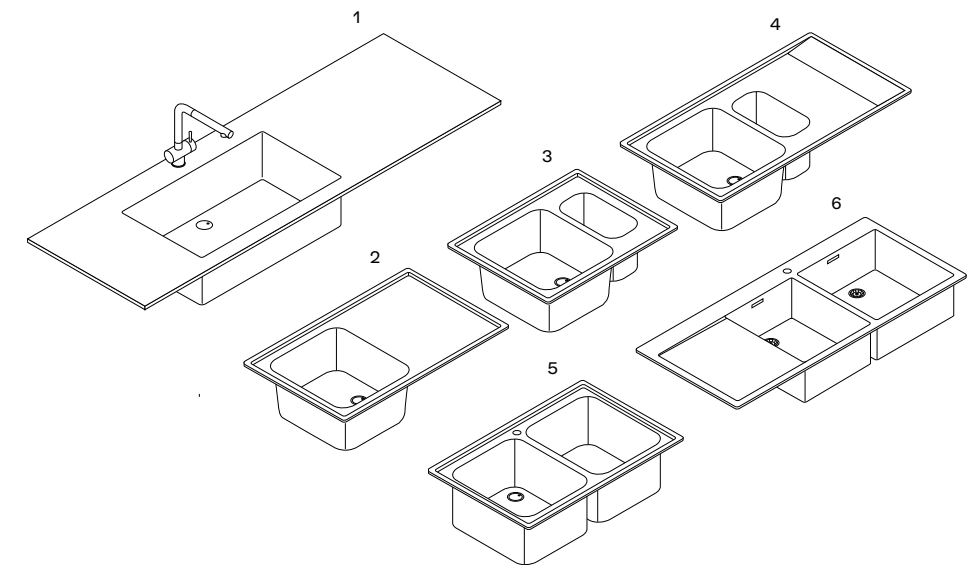

Tipologie di incasso Built-in types



Appoggio h 40 mm
Surface-mounted h 1 1/2"

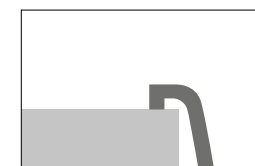

Incasso
Standard built-in

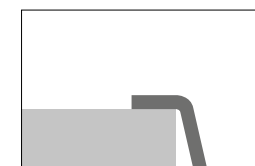

Finotop
Flush built-in

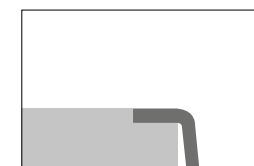

Filotop
Fully flush built-in

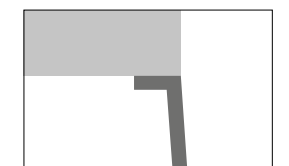

Sottotop
Under-top mounted

CAPPE HOODS

Infinity, sistema modulare

Moduli personalizzati Poliform da assemblare per configurazioni a isola con illuminazione led integrata.

- 1 Modulo aspirante luminoso
l 1050-1200-1500 con carter da 450
l 1800-2400 con carter da 600.
- 2 Modulo fitostimolante luminoso
con teca in vetro bassa o alta
l 600-750-900.
- 3 Modulo luminoso con teca in
vetro bassa o alta
l 600-750-900.
- 4 Modulo luminoso
l 600-750-900-1050-1200.

Infinity, modular system

Poliform personalized modules to be assembled for island configurations with integrated led light.

- 1 Lighted suction module
l 41 1/4"-47 1/4"-59" with carter of 17 3/4"
l 70 3/4"-92 1/2" with carter of 23 1/2".
- 2 Phytostimulant lighted module
with low or high glass case
l 23 1/2"-29 1/2"-35 1/2".
- 3 Lighted module with low or
high glass case
l 23 1/2"-29 1/2"-35 1/2".
- 4 Lighted module
l 23 1/2"-29 1/2"-35 1/2"-41 1/4"-47 1/4".

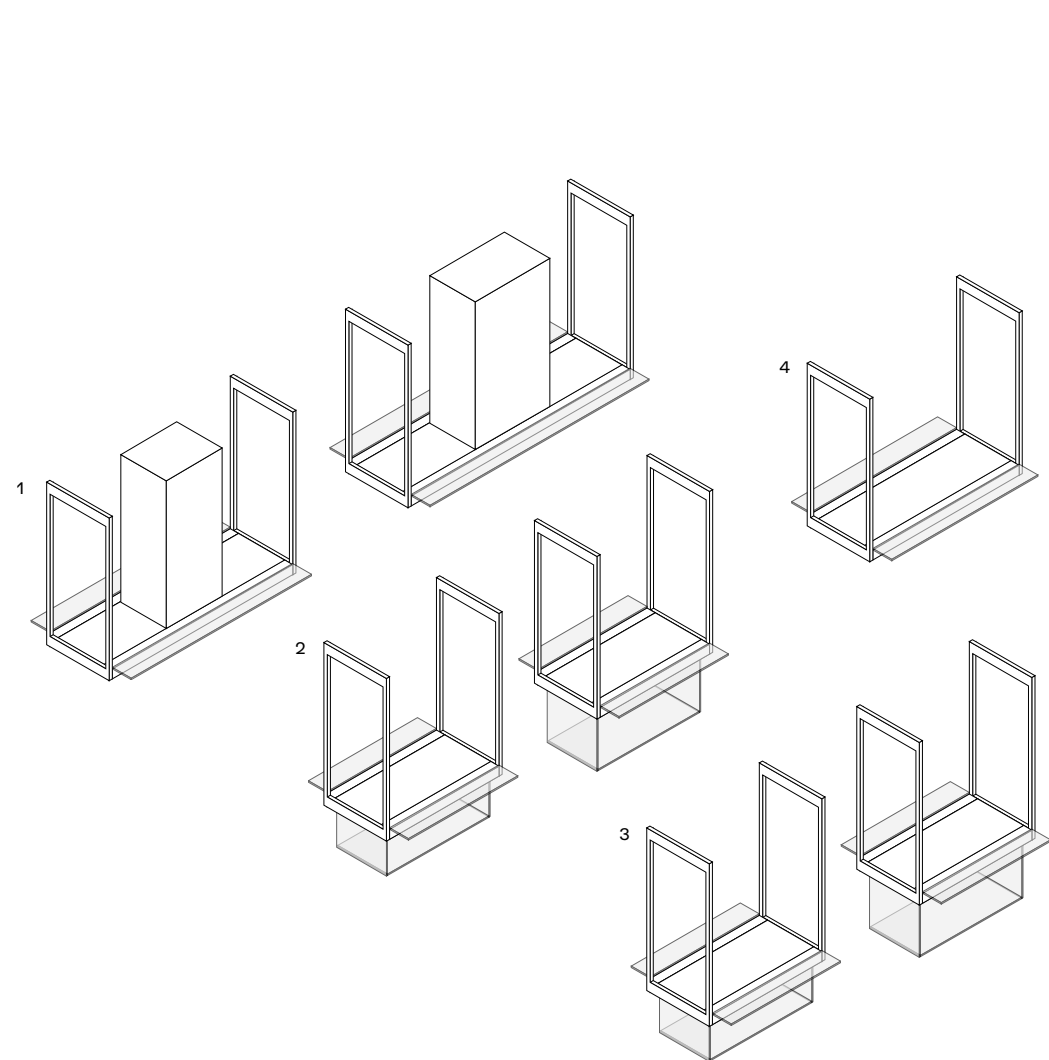

Cappe personalizzate Poliform

- 1 Cappa Piatta a parete e a isola.
- 2 Cappa Factory a isola.
- 3 Cappa Flat a parete e a isola.
- 4 Cappa Box a parete e a isola.
- 5 Cappa Glass a isola.
- 6 Cappa Work a parete e a isola.

Poliform personalised hoods

- 1 Piatta wall mounted, island-hood.
- 2 Factory island-hood.
- 3 Flat wall mounted, island-hood.
- 4 Box wall mounted, island-hood.
- 5 Glass island-hood.
- 6 Work wall mounted, island-hood.

Cappe integrate

- 7 Cappa a scomparsa.
- 8 Cappa Easy integrata nel pensile,
per piani cottura a gas o induzione.
- 9 Cappa Downdraft a scomparsa
nel top.

Integrated hoods

- 7 Retractable hood.
- 8 Easy built-in hood in the wall unit,
for gas or induction hobs.
- 9 Downdraft retractable hood
in the top.

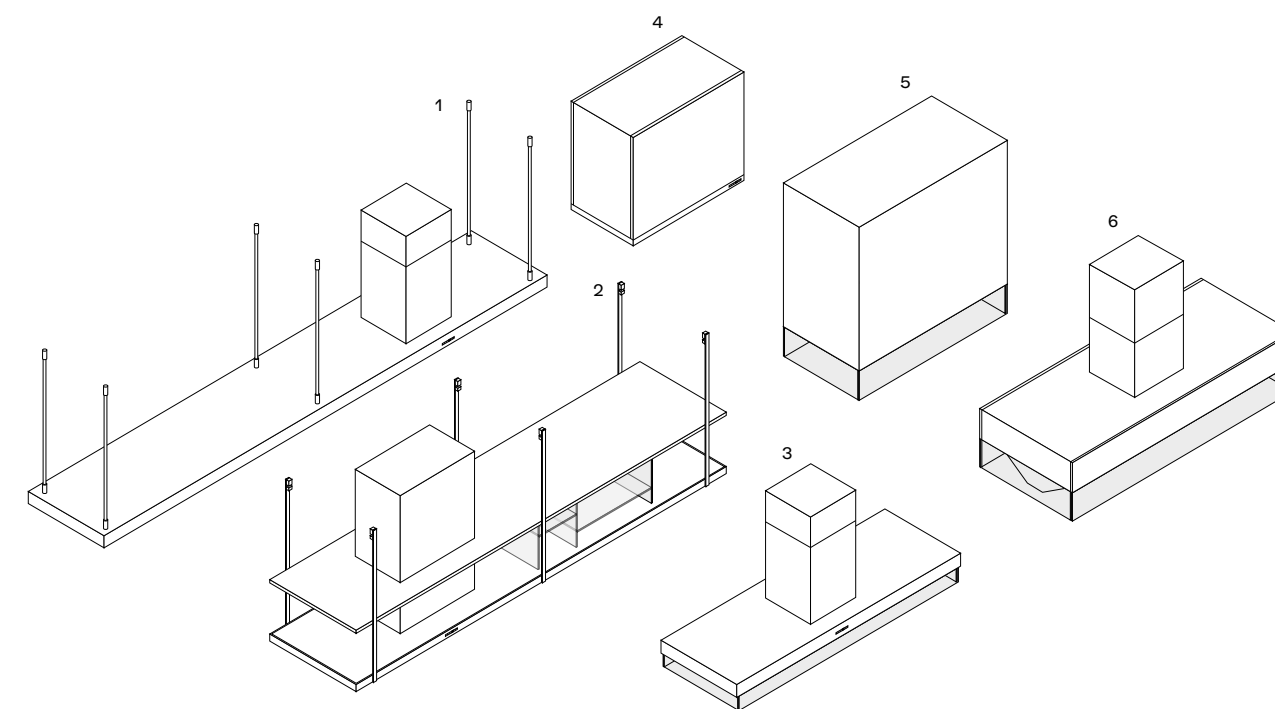

Cappe integrate Integrated hoods

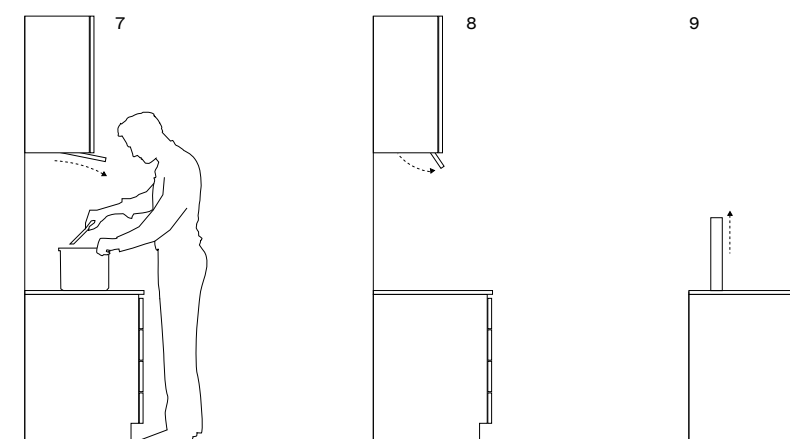

PORTARIFIUTI WASTEBINS

Basi con portarifiuti

- 1 Base livello con due estrattori o estrattore unico
1A - pattumiera raccolta differenziata T2 l 600-750-900-1050-1200 h 260.
1B - Kit sottovasca.
- 2 Base con estrattore unico
2A - pattumiera P-One l 450-600 h 550.
- 3 Base livello con estrattore unico
3A - pattumiera P-One l 600 h 360.
- 4 Base livello con anta battente
4A - pattumiera estraibile l 260 h 350.
4B - pattumiere ad estrazione totale l 275-390 h 380.
4C - pattumiera raccolta differenziata l 600-900-1200 h 360.

Base units with waste bins

- 1 Base unit with two pull-out baskets or single basket.
1A - waste bin for separate waste collection T2 - w 23 1/2"-29 1/2"- 35 1/2"- 41 1/4"- 47 1/4" h 10 1/4"
1B - Sink base kit.
- 2 Base unit with single pull-out basket.
2A -waste bin P-One w 17 3/4"-23 1/2" h 21 3/4".
- 3 Sink base unit with single pull-out basket
3A - waste bin P-One w 23 1/2" h 14 1/4".
- 4 Sink base unit with leaf door.
4A - pull-out waste bin w 10 1/4" h 13 3/4".
4B - waste bin with full extension glides w 10 3/4"-15 1/4" h 15".
4C - waste bin for separate waste collection w 23 1/2"-35 1/2"-47 1/4" h 14 1/4".

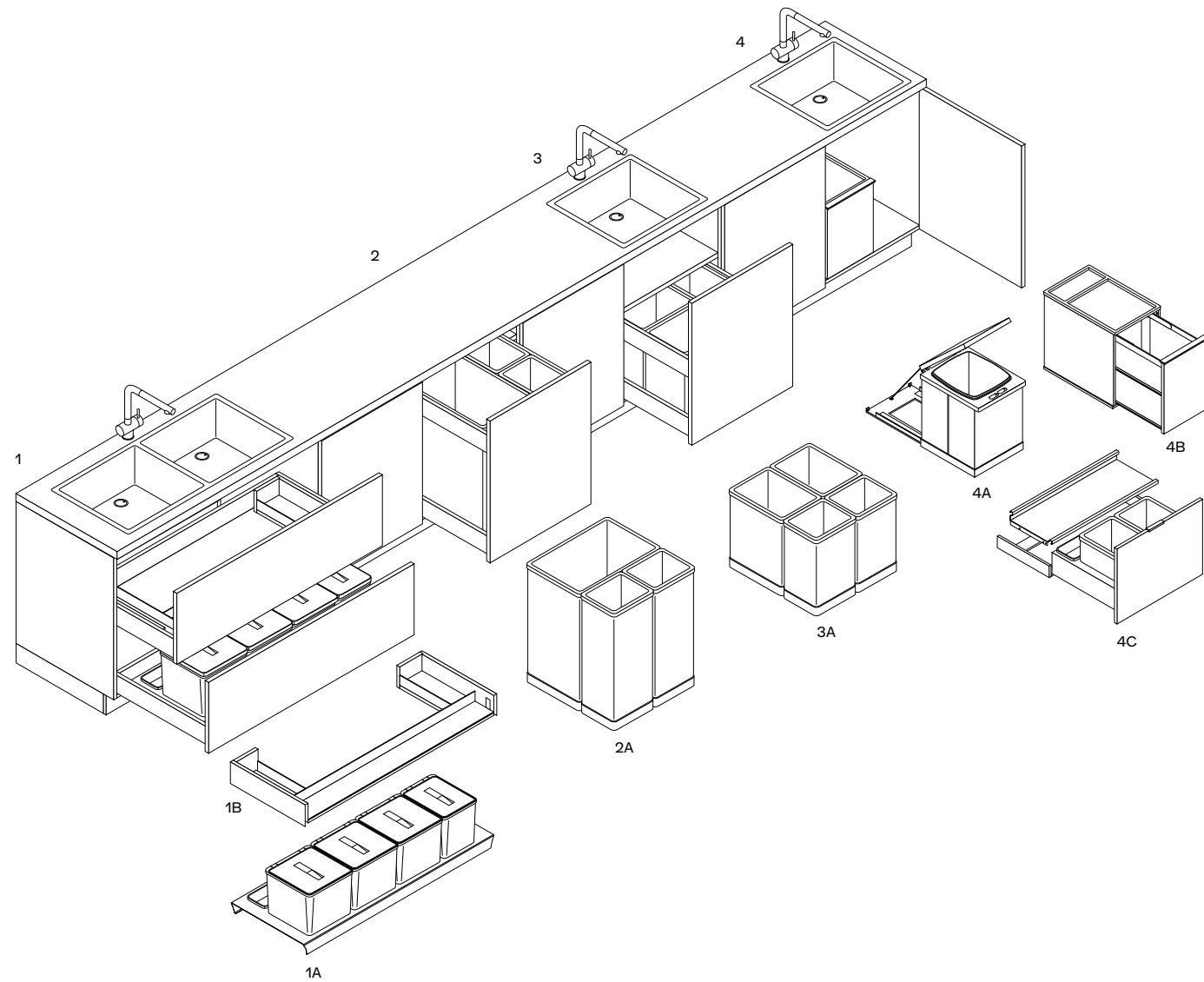

SOLUZIONI DI ILLUMINAZIONE LIGHTING SOLUTIONS

Illuminazione sul piano di lavoro

- 1 Sagoma con illuminazione multiled.
- 2 Faretto integrati sottopensile multiled.
- 3 Barra retrospensile multiled.
- 4 Barra sottopensile luminosa multiled.

Lighting on worktop

- 1 Profile with multiled lighting.
- 2 Built-in multiled spotlights.
- 3 Multiled bar to the back of the wall unit.
- 4 Multiled lighted bar under wall unit.

Multiled interno contenitori

- 5 Cassetti.
- 6 Estrattori.
- 7 Ante battenti.
- 8 Pensili.
- 9 Colonne.

Units internal multiled

- 5 Drawers.
- 6 Pull-out baskets.
- 7 Leaf doors.
- 8 Wall units.
- 9 Tall units.

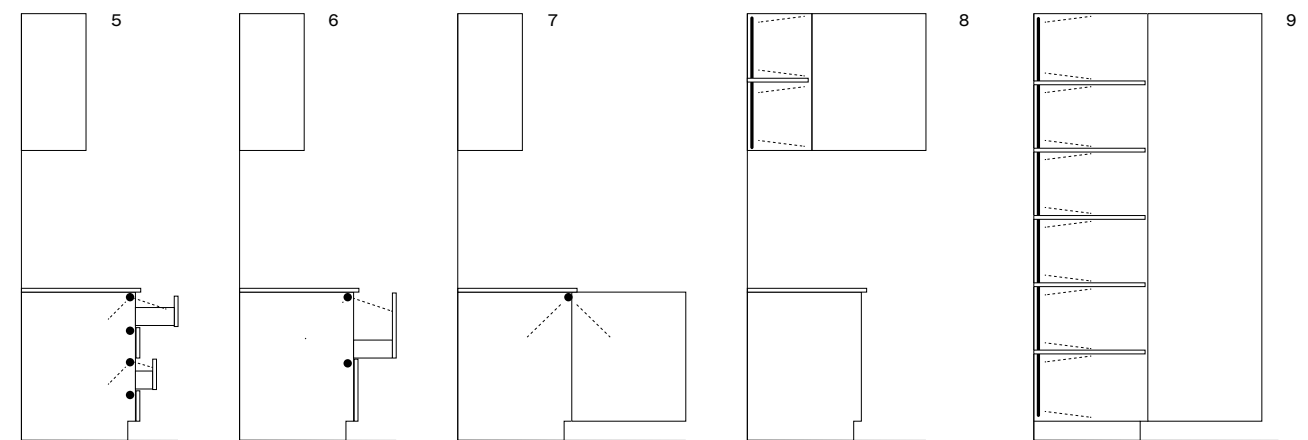
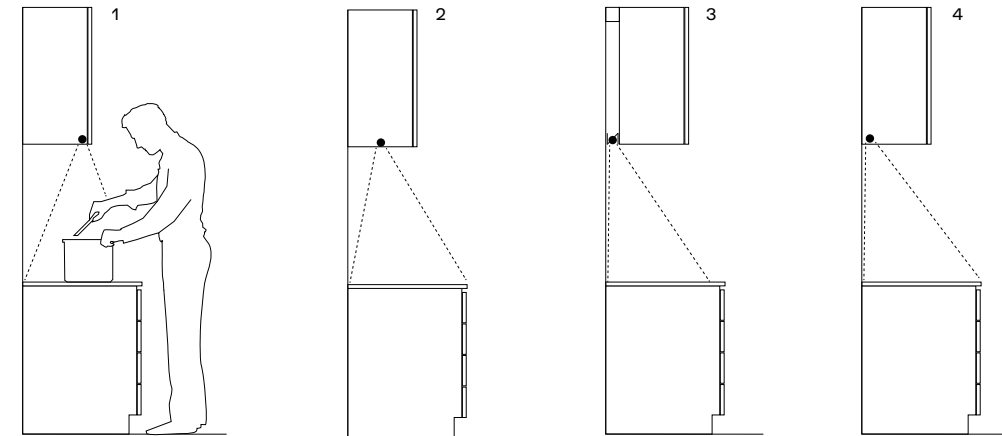

PIANI SNACK SNACK TABLES

Modelli e caratteristiche

- 1 Snack sp. 80 due lati folding con telaio. Da utilizzare sospeso o con gambe. Piano dogato in rovere, rovere spessart, rovere tinto grigio, rovere cenere, olmo nero, noce nazionale o massello di noce canaletto. Gambe e traversi alluminio finitura acciaio o laccato goffrato colori. l da 1800 a 2700 - passo 300 p 900-950-1050-1150-1200-1280.
- 2 Snack sp. 80 quattro lati folding. Da utilizzare sospeso o con gambe. Piano dogato in rovere, rovere spessart, rovere tinto grigio, rovere cenere, olmo nero, noce nazionale o massello di noce canaletto. Gambe cilindriche acciaio. l da 1800 a 2700 - passo 300 p 900-950-1050-1150-1200-1280.
- 3 Snack sp. 52. Da utilizzare su top sp. 6-12-20 con telaio di supporto alluminio previsto per modelli Artex, Twelve, Phoenix e Trail. Piano in rovere, rovere spessart, rovere tinto grigio, rovere cenere, olmo, olmo nero o noce c.; massello di noce nazionale, black ash o tinto olmo nero; laminato tuttocolore, laminato tuttocolore touch, laccato goffrato colori o in DuPont Corian®. Sui piani in laminato è previsto sul bordo un inserto in tinta o a contrasto nei colori dei laminati. l fino a 3000 snack laccati o legno l fino a 3600 snack in DuPont Corian® l fino a 4100 snack in laminato Sporgenza minima dalle basi 350 mm.
- 4 Snack sp. 80 a penisola quadrato. Da utilizzare su top sp. 6-12 con telaio di supporto alluminio previsto per modelli Twelve, Phoenix e Trail e sui top sp. 20. Piano dogato e gamba di sostegno in rovere, rovere spessart, rovere tinto grigio, rovere cenere, olmo nero o massello di noce canaletto. l 1500 x 1500 - 1800 x 1800.
- 5 Snack Moon sp. 40. Ø 1500 con due gambe. Ø 1800 con tre gambe e piano centrale girevole integrato. Piano in rovere fossile, black ash o olmo nero, gambe e inserto finta gamba in massello di rovere fossile, black ash o tinto olmo nero. Piano centrale girevole in tutti i marmi e pietre previste in collezione.

- 6 Snack Sydney sp. 40. Da utilizzare sospeso o con gamba. Piano e gamba in massello di noce, black ash o tinto olmo nero. Sydney l 1550-1700-1850-2150 x 788 l 2450 x 895. Sydney con gamba l 1850 x 900 - 2150 x 1000.
- 7 Snack Blade sp. 40. Da utilizzare sospeso o con gambe. Piano e gambe in massello di noce canaletto, black ash o tinto olmo nero. La lunghezza dello snack rettangolare si può personalizzare al centimetro. Rettangolare da l 1400 a l 2700, p 900-950-1050-1150-1200-1280. Quadrato 1500 x 1500.

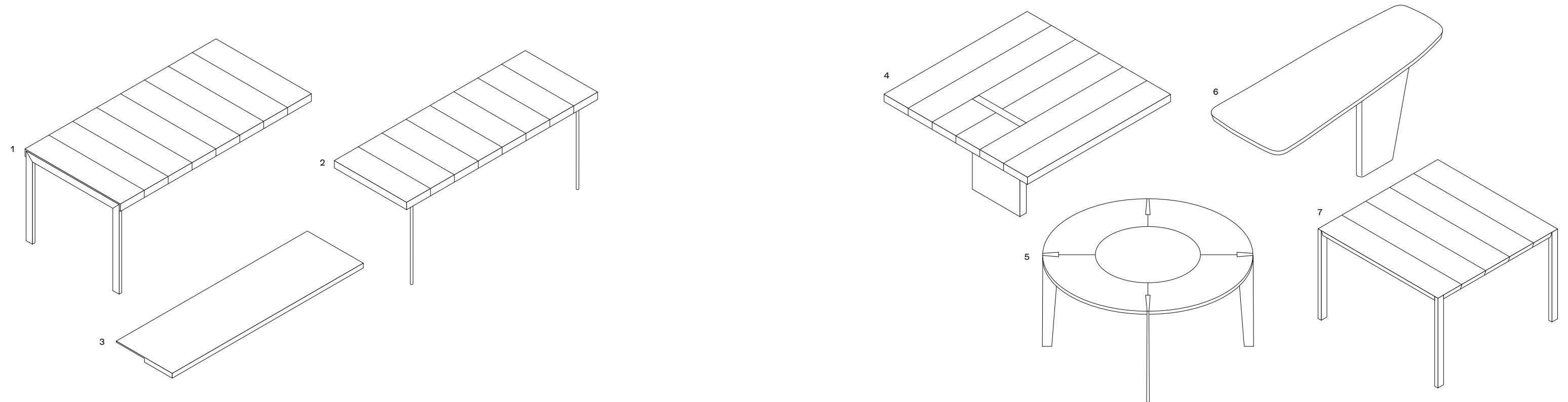

Models and features

- 1 Snack th. 3 1/4" with two sides "folding" and frame. For suspended use or with legs. Slatted top in oak, spessart oak, dyed grey oak, cenere oak, black elm, Italian walnut or solid walnut canaletto. Legs and aluminium crossbars finish steel or embossed lacquer colours. w from 70 3/4" to 106 1/4" - pitch 11 3/4" d 35 1/2"-37 1/2"-41 1/4"-45 1/4"-47 1/4"-50 1/2".
- 2 Snack th. 3 1/4" four sides "folding". For suspended use or with legs. Slatted top in oak, spessart oak, dyed grey oak, cenere oak, black elm, Italian walnut or solid walnut canaletto. Cylindrical legs in steel. w from 70 3/4" to 106 1/4" - pitch 11 3/4" d 35 1/2"-37 1/2"-41 1/4"-45 1/4"-47 1/4"-50 1/2".
- 3 Snack th. 2". To be used on worktop th. 1/4"-1/2"-3/4" with aluminium supporting frame for the models Artex, Twelve, Phoenix and Trail. Top in oak, spessart oak, grey stained oak, cenere oak, elm, black elm or walnut c.; solid Italian walnut, black ash or stained black elm; laminate tuttocolore, laminate tuttocolore touch, embossed lacquer colours or in DuPont Corian®. On the edge of the laminate worktops, an inlay in contrast or matching colour is available. w up to 118" snack in lacquer or wood w up to 141 3/4" snack in DuPont Corian® w up to 161 1/2" snack in laminate Minimum overhang of the base units 13 3/4".
- 4 Square peninsula snack th. 3 1/4". To be used on worktop th. 1/4"-1/2" with supporting aluminium frame for the models Twelve, Phoenix and Trail and on worktops th. 3/4". Slatted top and supporting leg in oak, spessart oak, grey stained oak, cenere oak, black elm or solid walnut canaletto. w 59" x 59" - 70 3/4" x 70 3/4".
- 5 Snack Moon th. 1 1/2". Ø 59" with two legs. Ø 70 3/4" with three legs and swivel integrated central top. Top in fossil oak, black ash or black elm, legs and inlay as a leg in solid fossil oak, black ash or stained black elm. Swivel central top in all the marbles and stones in the collection.
- 6 Snack Sydney th. 1 1/2". For suspended use or with leg. Top and leg in solid walnut, black ash or stained black elm. Sydney w 61"-67"-72 3/4"-84 3/4" x 31" w 96 1/2" x 35 1/4". Sydney with leg w 72 3/4" x 35 1/2" - 84 3/4" x 39 1/4".
- 7 Snack Blade th. 1 1/2". For suspended use or with legs. Top and legs in solid walnut canaletto, black ash or stained black elm. The length of the rectangular snack can be customized to the centimeter. Rectangular from w 55" to 106 1/4", d 35 1/2"-37 1/2"-41 1/4"-45 1/4"-47 1/4"-50 1/2". Square 59" x 59".

TAVOLI TABLES



Kensington
Design Jean-Marie Massaud, 2018

Struttura in alluminio spatolato ferro e bronzo o laccato opaco champagne. Piano in olmo nero, vetro fumé, marmo lucido noir saint laurent, marmo levigato e lucido bianco carrara, grigio stardust, calacatta oro o sahara noir finitura poliestere.

Il piano è caratterizzato dall'accostamento di moduli di forme e misure diverse.

Structure in aluminium with spatula finish ferro and bronzo or champagne mat lacquered. Top in black elm, fumé glass, glossy marble noir saint laurent, mat and glossy marble bianco carrara, grigio stardust,



calacatta oro or sahara noir with polyester finish. The top is distinguished by the combination of modules with different shape and size.

Dimensioni mm: rettangolare 2600 x 1200 3000 x 1200 h 740

rotondo Ø 1600 - Ø 2000 h 740

Dimensions in: rectangular 102 1/4" x 47 1/4"

118" x 47 1/4" h 29 1/4"

round Ø 63" - Ø 78 3/4" h 29 1/4"



Henry
Design Emmanuel Gallina, 2019

Tavolo fisso o allungabile. Struttura in olmo nero o noce gold. Piano in olmo nero, noce gold, cinque marmi levigati e sei lucidi, vetro lucido nei colori ghiaccio, arena, grafite, bordeaux. Allungabile solo in essenza. Fixed or extendable table. Structure in black elm or walnut gold finish. Top in black elm, walnut gold, five mat marbles and six glossy marbles, glossy glass in the colours ghiaccio, arena, grafite, bordeaux. Extendable table only version in wood.

Dimensioni mm: rettangolare 2400 x 1080 - 2850 x 1080 h 740, quadrato 1700 x 1700 h 740 allungabile 1800/2400 x 1000 h 740

Dimensions in: rectangular 94 1/2" x 42 1/2" - 112 1/4" x 42 1/2" h 29 1/4", square 67" x 67" h 29 1/4" extendable 70 3/4"/94 1/2" x 39 1/4" h 29 1/4"



Concorde
Design Emmanuel Gallina, 2009

Struttura in massello, finitura in noce gold, noce c., rovere spessart, rovere cenere o olmo nero. Piano in noce gold, noce c., rovere spessart, rovere cenere, olmo nero, cinque marmi levigati e sei lucidi. Per le versioni rettangolari è disponibile anche il piano in vetro lucido colori o in vetro riflettente blu con cornice in essenza. Per i tavoli Ø 1800 e 2000 mm è previsto un piano girevole opzionale in appoggio in laccato opaco colori, laccato lucido colori, noce gold, noce c., rovere spessart, rovere cenere, olmo nero, cinque marmi levigati e sei lucidi.



Structure in solid wood finish in walnut gold, walnut c., spessart oak, cenere oak or black elm. Top in walnut gold, walnut c., spessart oak, cenere oak, black elm, five mat and six glossy marble finishes. For the rectangular versions, the tabletop is available also in glossy glass or in blue reflecting glass with wooden frame. For the tables Ø 70 3/4" and 78 3/4" mm an optional swivel tray lean on the tabletop in the following finishes is available: mat lacquered colours, glossy lacquered colours, walnut gold, walnut c., spessart oak, cenere oak, black elm, five mat and six glossy marble finishes.



Dimensioni mm: rettangolare 2185 x 1080 - 2400 x 1080 - 2800 x 1080 h 740 rotondo Ø 1370 - Ø 1800 - Ø 2000 h 740 Ø 1800 piano girevole opzionale Ø 900 Ø 2000 piano girevole opzionale Ø 1050 Dimensions in: rectangular 86" x 42 1/2" - 94 1/2" x 42 1/2" - 110 1/4" x 42 1/2" h 29 1/4" round Ø 54" - Ø 70 3/4" - Ø 78 3/4" h 29 1/4" Ø 70 3/4" optional spinning tray Ø 35 1/2" Ø 78 3/4" optional spinning tray Ø 41 1/4"



Mondrian
Design Jean-Marie Massaud, 2019

Struttura in fusione di alluminio, finitura brown nickel opaco o champagne opaco.

Piano in olmo nero, noce gold, vetro fumé, cinque marmi levigati e sei lucidi.

Structure in aluminium casting, finish mat brown nickel or mat champagne.

Top in black elm, walnut gold, fumé glass, five mat marbles and six glossy marbles.



Dimensioni mm: ellittico 2400 x 1220 - 2800 x 1300 h 740

rotondo Ø 1400 - Ø 1600 h 740

Dimensions in: ellittico 94 1/2" x 48" -

110 1/4" x 51 1/4" h 29 1/4"

round Ø 55" - Ø 63" h 29 1/4"



Blade
Design R&D Poliform, 2014

Struttura e piano in massello di noce canaletto, massello black ash o massello tinto olmo nero. Nella versione rettangolare la lunghezza del tavolo si può personalizzare al centimetro.

Structure and top in solid canaletto walnut, solid black ash or solid wood stained black elm. The length of the rectangular table can be customized. Dimensioni mm: quadrato 1100 x 1100 - 1400 x 1400 rettangolare da 1400 a 3000 x 1100 h 740

Dimensions in: square 43 1/4" x 43 1/4" - 55" x 55" rectangular from 55" to 118" x 43 1/4" h 29 1/4"



Home Hotel
Design Jean-Marie Massaud, 2016

Struttura in massello finitura olmo nero o massello noce gold. Piano in olmo nero, cinque marmi levigati e sei lucidi. Versione in noce gold disponibile solo con piano in marmo.

I tavoli Ø 1800 e 2000 mm hanno un piano girevole integrato in olmo nero, noce gold, cinque marmi levigati e sei lucidi. Per i tavoli Ø 1800 e 2000 con piani in marmo, il piano girevole è disponibile solo in olmo nero o noce gold.

Structure in solid wood finish black elm or solid walnut gold. Top in black elm, five mat marbles and six glossy



marbles. Version in walnut gold available only with top in marble. The tables Ø 70 3/4" and 78 3/4" have an integrated swivel top in black elm, walnut gold, five mat and six glossy marble finishes. For tables Ø 70 3/4" and 78 3/4" with marble top the swivel top is available only in black elm or walnut gold.

Dimensioni mm: rettangolare 2400 x 1100 3000 x 1100 h 740

rotondo Ø 1600 - Ø 1800 - Ø 2000 h 740

Ø 1800 piano girevole integrato Ø 900

Ø 2000 piano girevole integrato Ø 1100



Dimensioni in: rettangolare 94 1/2" x 43 1/4" - 118" x 43 1/4" h 29 1/4" round Ø 63" - Ø 70 3/4" - Ø 78 3/4" h 29 1/4" Ø 70 3/4" integrated spinning tray Ø 35 1/2" Ø 78 3/4" integrated spinning tray Ø 43 1/4"



Opéra
Design Emmanuel Gallina, 2014

Tavolo fisso o allungabile. Struttura in noce c. o rovere spessart. Piano in noce c., rovere spessart, cinque marmi levigati e sei lucidi. Nel tavolo allungabile con piano in marmo finitura prolunghe come la struttura. Fixed or extendable table. Structure in walnut c. or spessart oak. Top in walnut c., spessart oak, five mat and six glossy marble finishes. The extensions of the extendable table with marble top are in the same finish of the structure.

Dimensioni mm: fisso 2880 x 1100 h 740 allungabile 2080/2980 x 969 h 740

Dimensions in: fixed 113 1/2" x 43 1/4" h 29 1/4" extensible 82"/117 1/4" x 38 1/4" h 29 1/4"



Flute
Design Roberto Barbieri, 2008

Struttura laccato opaco colori, laccato lucido colori, laccato antigraffio o verniciato brown nickel opaco e lucido. Piano laccato opaco colori, laccato lucido colori, laccato antigraffio nei colori bianco 01, carbone 91, grafite 04, canapa 35, cinque marmi levigati e sei lucidi. Structure in mat lacquered colours, glossy lacquered colours, anti-scratch lacquered colours or brown nickel mat and glossy finishes. Top in mat lacquered colours, glossy lacquered colours, anti-scratch lacquer in the colours bianco 01, carbone 91, grafite 04, canapa 35, five mat and six glossy marble finishes.

Dimensioni mm: piano laccato Ø 900 - Ø 1250 - Ø 1400 - piano marmo Ø 900 - Ø 1230 - Ø 1370 h 740

Dimensions in: lacquered top Ø 35 1/2" - Ø 49 1/4" - Ø 55" - marble top Ø 35 1/2" - Ø 48 1/2" - Ø 54" h 29 1/4"



Howard
Design Jean-Marie Massaud, 2011

Struttura in massello, finitura in rovere spessart o olmo nero. Telaio in metallo tagliato a laser e piegato, verniciato brown nickel opaco. Piano in rovere spessart, cinque marmi levigati e sei lucidi.

Structure in solid wood, finishes spessart oak or black elm. Frame in laser cut and folded metal painted mat brown nickel. Top in spessart oak, five mat and six glossy marble finishes.

Dimensioni mm: 2200 x 1000 - 2800 x 1100 h 740

Dimensions in: 86 1/2" x 39 1/4" - 110 1/4" x 43 1/4" h 29 1/4"



Mad Dining Table
Design Marcel Wanders, 2015

Struttura in massello, finitura in rovere spessart o olmo nero. Piano in rovere spessart, olmo nero, cinque marmi levigati e sei lucidi.

Structure in solid wood, spessart oak or black elm finish. Top in spessart oak, black elm, five mat and six glossy marble finishes.

Dimensioni mm: 2200 x 1100 - 2790 x 1100 h 740

Dimensions in: 86 1/2" x 43 1/4" - 109 3/4" x 43 1/4" h 29 1/4"



Gill
Design Roberto Barbieri, 2010

Tavolo allungabile. Struttura in massello, finitura in rovere spessart. Piano in rovere spessart. Extendable table. Structure in solid wood spessart oak finish. Top in spessart oak.

Dimensioni mm: 1550/2100 x 900 h 740

1800/2350 x 900 h 740

2000/2620 x 1000 h 740

Dimensions in: 61"/82 3/4" x 35 1/2" h 29 1/4"

70 3/4"/92 1/2" x 35 1/2" h 29 1/4"

78 3/4"/103 1/4" x 39 1/4" h 29 1/4"



Trevi
Design Roberto Barbieri, 2005

Struttura in trafilato alluminio laccato opaco colori, laccato antigraffio o verniciato brown nickel opaco e lucido. Piano laccato opaco colori o laccato antigraffio nei colori bianco 01, carbone 91, grafite 04 e canapa 35. Structure in extruded aluminium in the finishes mat lacquered colours, anti-scratch lacquer or brown nickel mat and glossy. Top in mat lacquered colours, or anti-scratch lacquer in the colours bianco 01, carbone 91, grafite 04, canapa 35.

Dimensioni mm: quadrato 900 x 900 - 1250 x 1250 rettangolare 1400 x 800 - 1800 x 900 h 740

Dimensions in: square 35 1/2" x 35 1/2" - 49 1/4" x 49 1/4" rectangular 55" x 31 1/2" - 70 3/4" x 35 1/2" h 29 1/4"

SEDIE CHAIRS



Stanford Bridge
Design Jean-Marie Massaud, 2018

Scocca imbottita e rivestimento non sfoderabile in tessuto o pelle. Basamento girevole con ritorno, in brown nickel opaco e lucido o champagne opaco. Body upholstered and covered in non-removable fabric or leather. Base with automatic returning mechanism, in mat and glossy brown nickel or mat champagne. Dimensioni mm: sedia | 570 p 560 h 800 sedia con braccioli | 620 p 560 h 800 Dimensions in: chair w 22 1/2" d 22" h 31 1/2" chair with arms w 24 1/2" d 22" h 31 1/2"



Sophie
Design Emmanuel Gallina, 2017

Seduta imbottita e rivestimento non sfoderabile in tessuto o pelle. Struttura in noce gold, rovere spessart o olmo nero. Seat upholstered and covered in non-removable fabric or leather. Structure in walnut gold, spessart oak or black elm. Dimensioni mm: sedia | 570 p 600 h 780 sedia con braccioli | 630 p 600 h 780 dimensions in: chair w 22 1/2" d 23 1/2" h 30 3/4" chair with arms w 24 3/4" d 23 1/2" h 30 3/4"



Grace
Design Emmanuel Gallina, 2009

Seduta imbottita e rivestimento non sfoderabile in tessuto, pelle o pelle Nabuk intrecciata (solo per retro schienale). Struttura in noce gold, noce c., rovere cenere, rovere spessart o olmo nero. Seat upholstered and covered in non-removable fabric, leather or woven leather Nabuk (available only for the rear of the backrest). Structure in walnut gold, walnut c., cenere oak, spessart oak or black elm. Dimensioni mm: con/senza braccioli | 535 p 540 h 815 Dimensions in: with/without arms w 21" d 21 1/4" h 32"



Seattle
Design Jean-Marie Massaud, 2015

Seduta e schienale completamente rivestiti in cuoio non sfoderabile nei colori 19 caffè, 02 nero, 26 invecchiato o 29 tortora con punzonatura estetica (brogueing) perimetrale. Gambe in rovere spessart, rovere naturale e olmo nero o completamente rivestite in cuoio nei colori 19 caffè, 02 nero, 26 invecchiato o 29 tortora. Seat and backrest fully covered in non-removable hide in the colours 19 caffè, 02 nero, 26 invecchiato or 29 tortora with perimeter decorative punching

(brogueing). Legs in spessart oak, natural oak and black elm or fully covered in hide in the colours 19 caffè, 02 nero, 26 invecchiato or 29 tortora. Dimensioni mm: sedia | 530 p 550 h 790 sedia con braccioli | 560 p 550 h 790 Dimensions in: chair w 20 3/4" d 21 3/4" h 31" chair with arms w 22" d 21 3/4" h 31"



Ipanema
Design Jean-Marie Massaud, 2015

Seduta imbottita e rivestimento non sfoderabile in tessuto o pelle. Struttura in rovere spessart o olmo nero. Seat upholstered and covered in non-removable fabric or leather. Structure in spessart oak or black elm. Dimensioni mm: sedia | 540 p 545 h 815 sedia con braccioli | 575 p 545 h 815 Dimensions in: chair w 21 1/4" d 21 1/2" h 32" chair with arms w 22 3/4" d 21 1/2" h 32"



Ventura
Design Jean-Marie Massaud, 2011

Scocca imbottita e rivestimento non sfoderabile in tessuto o pelle. Cucitura normale doppia o solo per la versione in tessuto (escluso velluto) cucitura a cordoncino in tinta. Struttura in rovere cenere, rovere spessart o olmo nero. Body upholstered and covered in non-removable fabric or leather. Double normal stitching or drawstring stitching in matching colour, only for the version in fabric (except velvet). Structure in cenere oak, spessart oak or black elm.



Dimensioni mm: sedia | 505 p 540 h 815 sedia con braccioli | 555 p 540 h 815 Dimensions in: chair w 20" d 21 1/4" h 32" chair with arms w 21 3/4" d 21 1/4" h 32"



Ventura
Design Jean-Marie Massaud, 2011

Scocca imbottita e rivestimento non sfoderabile in tessuto o pelle. Struttura in metallo verniciato brown nickel opaco o laccato opaco colori. Body upholstered and covered in non-removable fabric or leather. Structure in mat or glossy brown nickel painted metal. Dimensioni mm: sedia | 505 p 540 h 815 sedia con braccioli | 555 p 540 h 815 Dimensions in: chair w 20" d 21 1/4" h 32" chair with arms w 21 3/4" d 21 1/4" h 32"



Mad Dining Chair
Design Marcel Wanders, 2015

Scocca imbottita e rivestimento non sfoderabile in tessuto o pelle. Possibilità di rivestimento diverso tra interno ed esterno della scocca. Il rivestimento Gibson matelassé è disponibile solo per la scocca interna. Gambe in rovere spessart o olmo nero. Body upholstered and covered in non-removable fabric or leather. The inner and outer cover can be in two different materials. Fabric Gibson matelassé is available only for the inner cover. Legs in solid wood in the finishes spessart oak or black elm.

Dimensioni mm: sedia | 480 p 575 h 790 sedia con braccioli | 630 p 575 h 790 dimensions in: chair w 19" d 22 3/4" h 31" chair with arms w 24 3/4" d 22 3/4" h 31"



Harmony
Design Rodrigo Torres, 2012

Scocca in legno curvato con tecnica 3d finitura rovere spessart. Struttura in massello, finitura rovere spessart o in tondino di metallo finitura in cromo nero. Body in curved wood with 3D technology, finish spessart oak. Structure in solid wood spessart oak finish or in metal rod in black chrome finish. Dimensioni mm: | 460 p 480 h 795 Dimensions in: w 18" d 19" h 31 1/4"



Guest
Design Rodolfo Dordoni, 2014

Scocca imbottita e rivestimento non sfoderabile in tessuto o pelle. Cuscino seduta con rivestimento sfoderabile in tessuto o pelle. Ruote a scomparsa. Body upholstered and covered in non-removable fabric or leather. Seat cushion with removable cover in fabric or leather. Invisible wheels. Dimensioni mm: | 575 p 610 h 835 Dimensions in: w 22 3/4" d 24" h 32 3/4"



Velvet
Design R&D Poliform, 2007

Seduta imbottita e rivestimento sfoderabile in tessuto o pelle. Gambe in laccato opaco colori, noce c. o rovere spessart. Seat upholstered and covered in removable fabric or leather. Legs in mat lacquered colour, walnut c. or spessart oak. Dimensioni mm: sedia | 525 p 560 h 770 sedia con braccioli | 580 p 590 h 770 Dimensions in: chair w 20 3/4" d 22" h 30 1/4" chair with arms w 22 3/4" d 23 1/4" h 30 1/4"



Velvet Due
Design R&D Poliform, 2007

Seduta imbottita e rivestimento sfoderabile in tessuto. Gambe in laccato opaco colori, noce c. o rovere spessart. Seat upholstered and covered in removable fabric. Legs in mat lacquered colour, walnut c. or spessart oak. Dimensioni mm: sedia | 575 p 590 h 770 sedia con braccioli | 580 p 590 h 770 Dimensions in: chair w 22 3/4" d 23 1/4" h 30 1/4" chair with arms w 22 3/4" d 23 1/4" h 30 1/4"



Manta
Design Rodrigo Torres, 2007

Seduta e gambe completamente rivestite in pelle non sfoderabile. Seat and legs fully covered in non-removable leather. Dimensioni mm: sedia | 520 p 530 h 770 sedia con braccioli | 570 p 550 h 770 Dimensions in: chair w 20 1/2" d 20 3/4" h 30 1/4" chair with arms w 22 1/2" d 21 3/4" h 30 1/4"



BB
Design Blumer e Borghi, 2008

Struttura completamente rivestita e non sfoderabile in cuoio co-stampato nei colori 02 nero, 03 grigio scuro, 19 caffè o 26 invecchiato. Structure fully covered in non-removable hide in the colours 02 nero, 03 grigio scuro, 19 caffè or 26 invecchiato. Dimensioni mm: | 465 p 535 h 780 Dimensions in: w 18 1/4" d 21" h 31 1/4"

SGABELLI STOOLS



Sophie
Design Emmanuel Gallina, 2018

Seduta e schienale con parti in poliuretano flessibile a quote differenziate e parti in poliuretano flessibile stampato, prerivestimento in fibra di poliestere. Rivestimento non sfoderabile in tessuto o pelle. Struttura in massello, finitura noce gold, rovere spessart o olmo nero. Poggiapiedi in metallo verniciato brown nickel opaco con inserto inox satinato. Seat and back with parts in flexible polyurethane in different densities and parts in moulded flexible

polyurethane, pre-cover in polyester fibre. Non-removable cover in fabric or leather. Structure in solid wood, finish walnut gold, spessart oak or black elm. Footrest in mat brown nickel painted metal with inlay in brushed stainless steel. Dimensioni mm: l 550 p 550 h 660/870 alto l 550 p 550 h 760/970 Dimensions in: w 21 3/4" d 21 3/4" h 26" 34 1/4" high w 21 3/4" d 21 3/4" h 30" 38 1/4"



Ventura
Design Jean-Marie Massaud, 2016

Scocca in poliuretano flessibile stampato, prerivestimento in fibra di poliestere. Rivestimento non sfoderabile in tessuto o pelle. Cucitura normale doppia o solo per la versione in tessuto (escluso velluto) cucitura a cordoncino in tinta. Struttura in massello, finitura rovere spessart o olmo nero. Poggiapiedi in acciaio inox. Body in moulded flexible polyurethane, pre-cover in polyester fibre. Non-removable cover in fabric or leather. Normal double stitching or drawstring

stitching in matching colour only for the fabric version (except velvet). Structure in solid wood, spessart oak or black elm finish. Footrest in stainless steel. Dimensioni mm: l 485 p 470 h 650/850 alto l 485 p 500 h 750/950 Dimensions in: w 19" d 18 1/2" h 25 1/2"/33 1/2" high w 19" d 19 3/4" h 29 1/2"/37 1/2"



Harmony
Design Rodrigo Torres, 2012

Scocca in legno curvato con tecnica 3D, finitura rovere spessart. Struttura in tondino di metallo finitura cromo nero. Body in curved wood with 3D technology, spessart oak finish. Structure in metal rod black chrome finish. Dimensioni mm: l 445 p 450 h 660/815 Dimensions in: w 17 1/2" d 17 3/4" h 26" 32"



Ics
Design Rodrigo Torres, 2010

Seduta in rovere spessart. Struttura in massello, finitura rovere spessart con poggiapiedi in acciaio inox. Seat in spessart oak. Structure in solid wood, spessart oak finish with footrest in stainless steel. Dimensioni mm: l 440 p 340 h 660 Dimensions in: w 17 1/2" d 13 1/2" h 26"

PANCHE BENCHES



Home Hotel
Design Jean-Marie Massaud, 2016

Seduta in olmo nero rivestita in cordatura di pelle testa di moro. Struttura in massello, finitura olmo nero. Cuscino opzionale con rivestimento sfoderabile in tessuto o pelle; nella versione pelle Nabuk possibilità pelle Nabuk intrecciata nella parte superiore. Seat in black elm, covered with dark brown stringed leather. Structure in solid wood, black elm finish. Optional cushion with removable cover in fabric or leather; in the version in leather Nabuk, the upper part can be in woven leather. Dimensioni mm: l 1000 p 490 h 440 l 1440 p 490 h 440 Dimensions in: w 20" d 21 1/4" h 32" w 21 3/4" d 21 1/4" h 32"



Jane
Design Emmanuel Gallina, 2017

Seduta in poliuretano flessibile a quote differenziate, prerivestimento in fibra di poliestere. Rivestimento in tessuto sfoderabile o in pelle non sfoderabile. Struttura in massello, finitura noce gold, rovere spessart o olmo nero. Struttura in metallo verniciato brown nickel opaco o lucido. Seat in flexible polyurethane in different densities, pre-cover in polyester fibre. Cover in removable fabric or in non-removable leather. Structure in solid wood, walnut gold, spessart oak or black elm finish. Structure in mat or glossy brown nickel painted metal. Dimensioni mm: l 1300 p 500 h 480 Dimensions in: w 51 1/4" d 19 3/4" h 19"

FINITURE
FINISHINGS

Laccato gofrato e lucido
Embossed and glossy lacquered

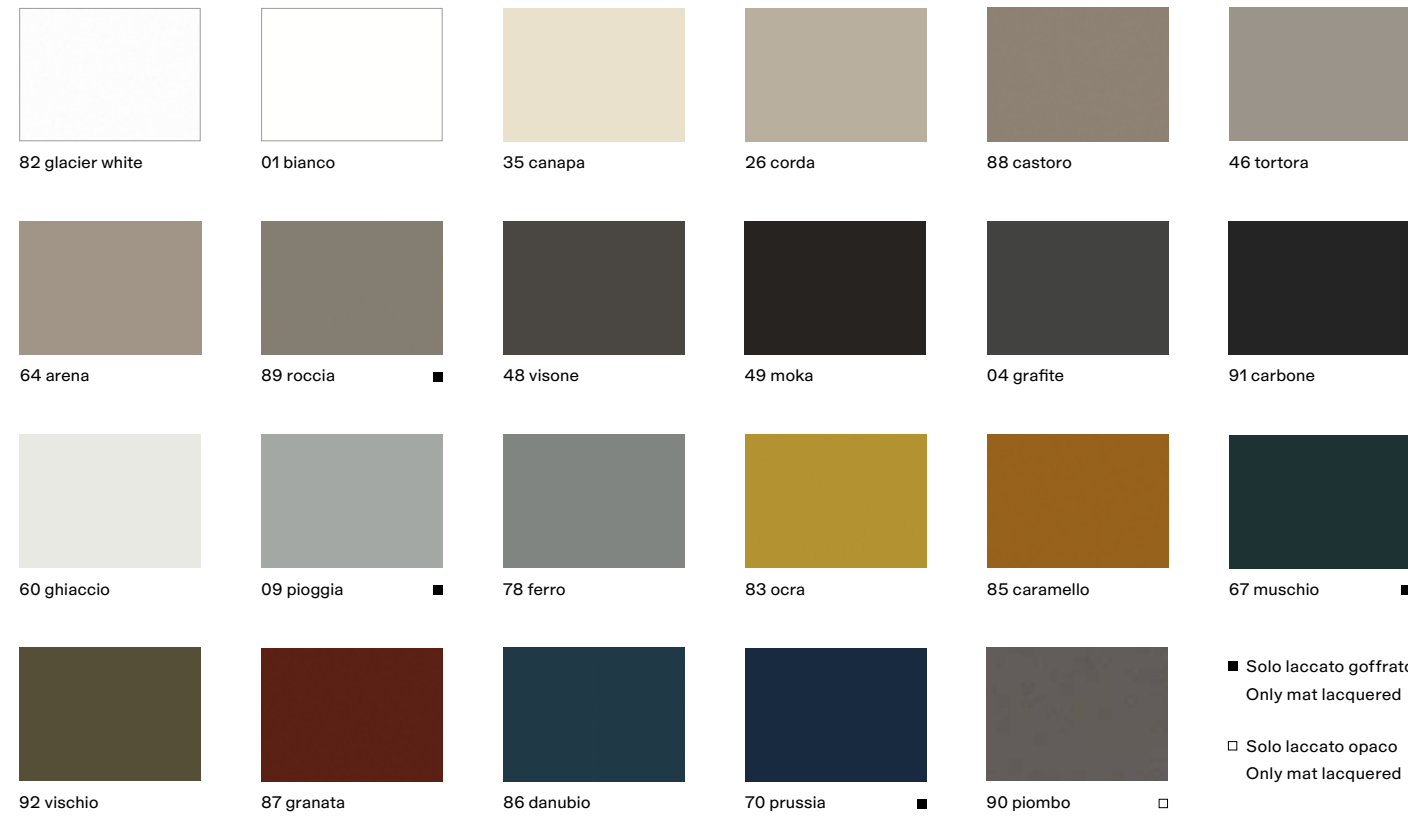

■ Solo laccato gofrato
Only mat lacquered

□ Solo laccato opaco
Only mat lacquered

Laccato metallico
Metallic lacquered



Vetro riflettente
Reflecting glass

Vetro satinato
Frosted glass

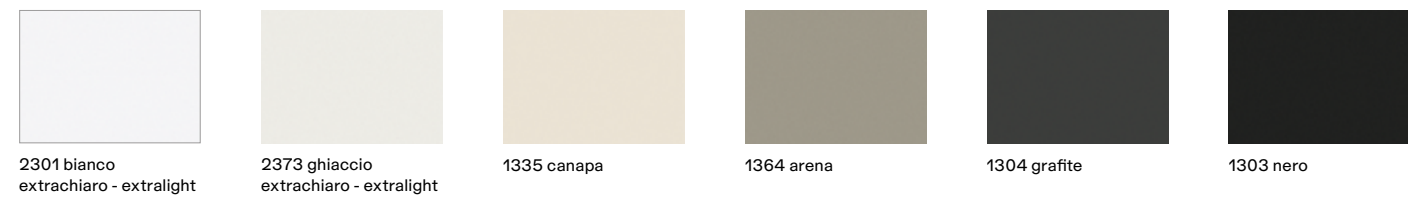

Vetro lucido
Glossy glass



Essenze
Woods

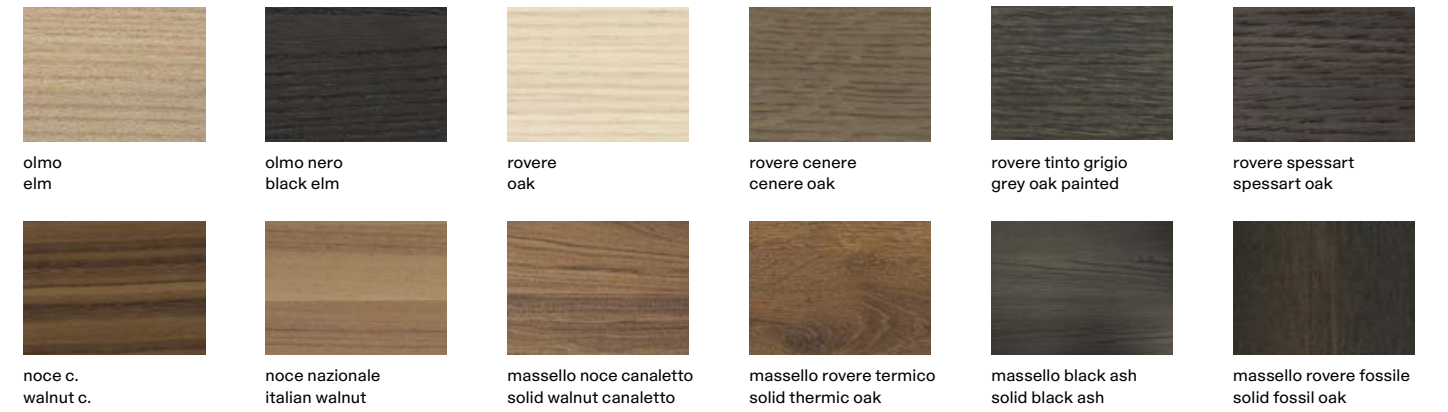

Nobilitato
Melamine



Nobilitato silk
Silk melamine



Laminato opaco
Mat laminate

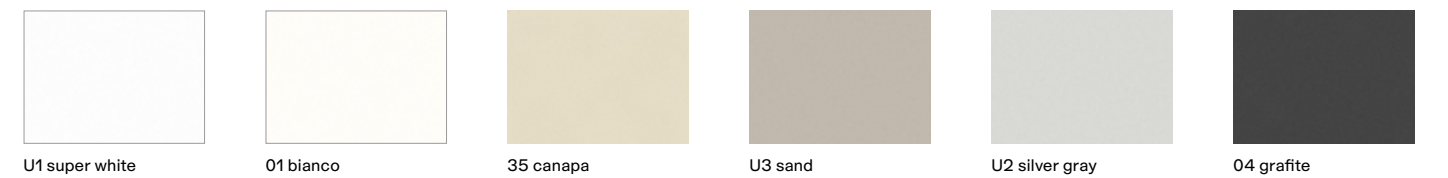

Laminato opaco touch
Mat laminate touch

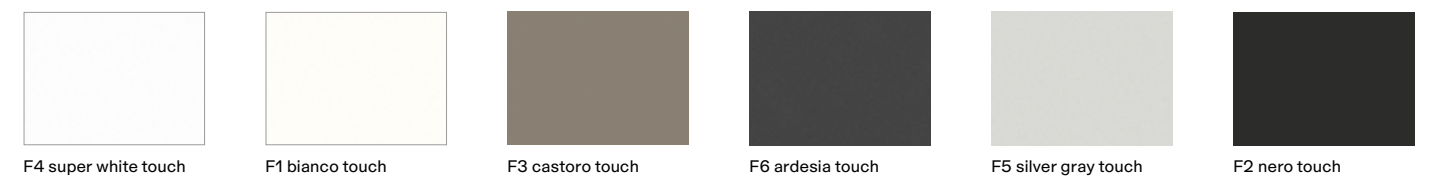

FINITURE
FINISHINGS

Quarzite lucida
Glossy composite stone

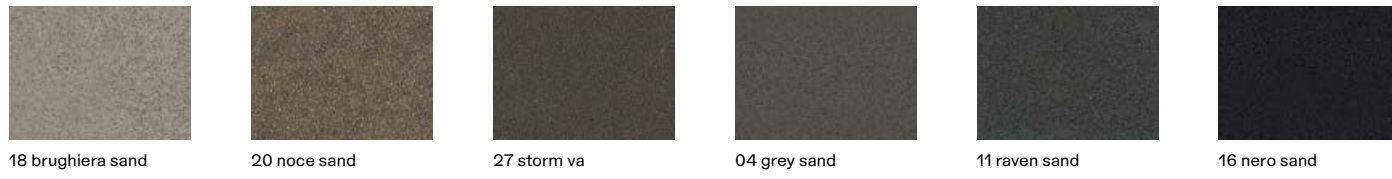

Quarzite micropallinata
Micro-blasted composite stone

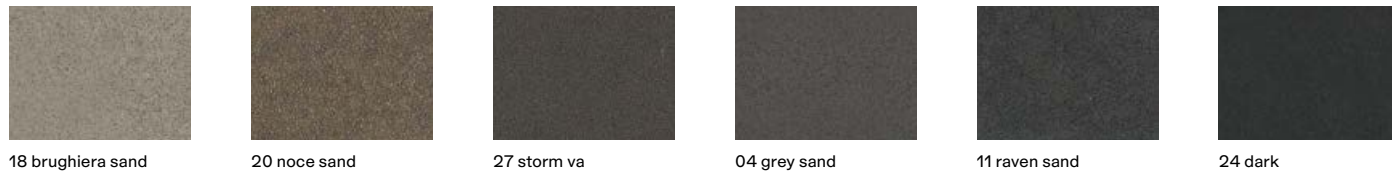

Marmo levigato
Mat marble

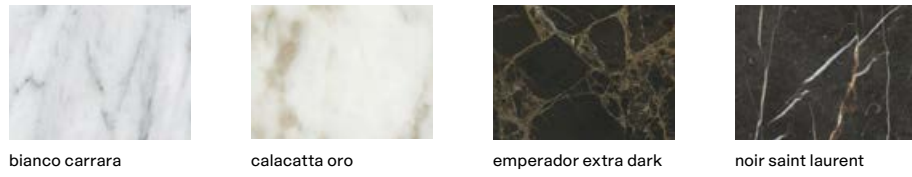

Marmo lucido
Glossy marble

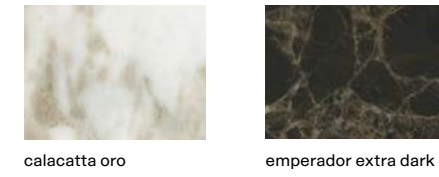

Pietra
Stone



Inalco MDi®
Inalco MDi®



Acciaio
Steel

Dekton
Dekton



DuPont Corian®
DuPont Corian®

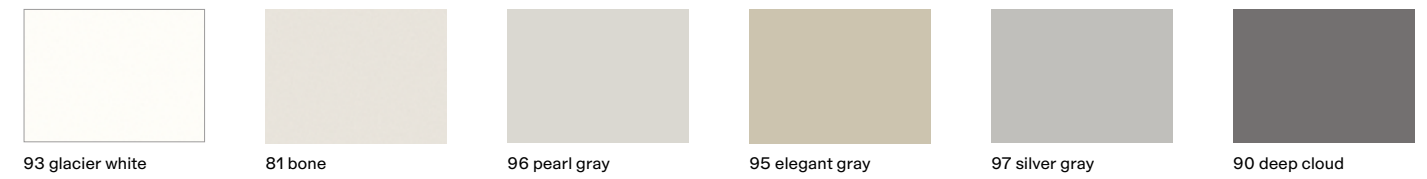

Laminato tuttocolore
Tuttocolore laminato

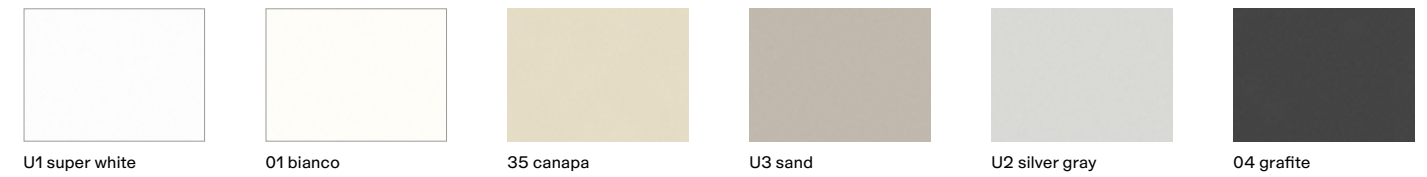

Laminato tuttocolore touch
Tuttocolore laminate touch

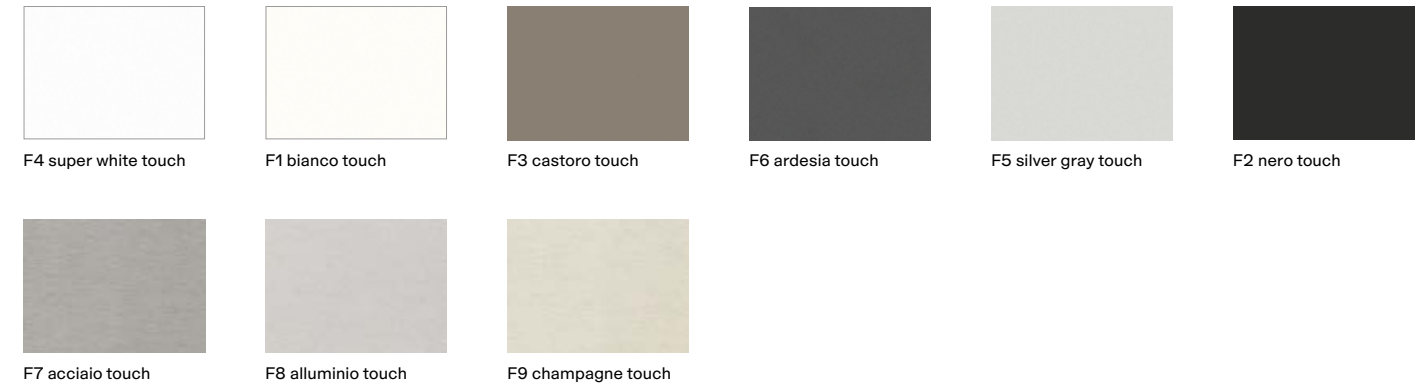

Poliform Spa

via Montesanto 28
Casella postale n. 1
22044 Inverigo (CO) Italy
t +39 031 6951
f +39 031 699444
info@poliform.it
poliform.it

Poliform realizza tutte le sue collezioni in Italia usando componenti e materie prime selezionate.

All the Poliform collections are manufactured 100% in Italy using top-class components and materials.

Poliform si riserva il diritto di apportare, senza preavviso, ogni modifica mirata al miglioramento funzionale e qualitativo dei propri prodotti. Testi e disegni presenti in questo stampato hanno scopo divulgativo; per ogni aspetto tecnico e dimensionale fare riferimento ai listini aziendali e relativi aggiornamenti. I campioni di colori e materiali hanno valore indicativo.

Poliform reserves the rights at all time to apply modifications for the functional or qualitative improvement of its products. Texts and drawings present in this brochure have a divulgative purpose; for every technical and dimensional aspect please refer to the company's price lists and their relative updatings. The colour and material samples have an indicative value.



2018 Adi Compasso D'oro
Career Award