



????????

????????

???????? ???? ? ???? ??, ????? ???? ??????

????????

???????? ? ??????

????????

???? ? ????????????????? ???? , ????? ???? ?

????

???????? ???? ?????

???? ???? ???? ?

???????????????? ???? ???? ? ???? ?

????????

???????? ? ? ?

???? ? ? ?

???????????????? ???? ???? ?

???????????????? ?

???????? ? ? ?

???????????? ?

???????????? ???? ???? ?

???? ? ? ?

?????: ????????? ? ? ?

?????: ????????? ???? , ????????? ?

???????????? Slim / ?

???? ? ????????????????? ? ? ? ????????????? ? ? ? ? ?

???????

???????

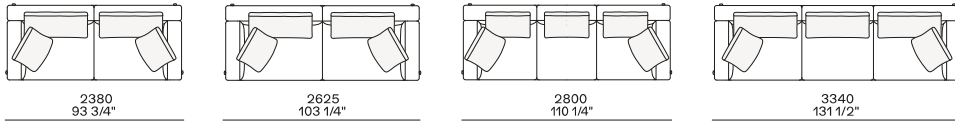

?????, ?????-?????

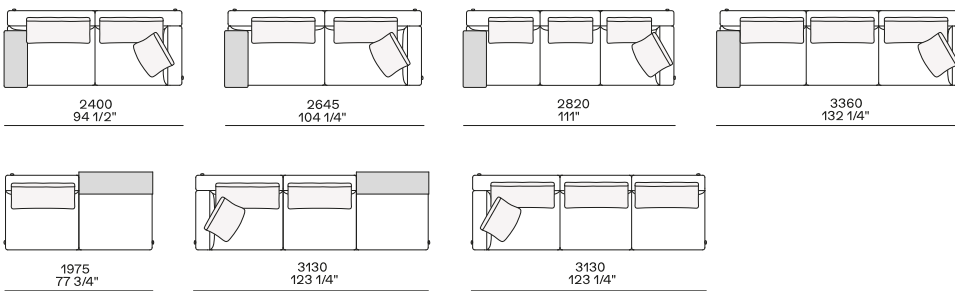

????????? ?????

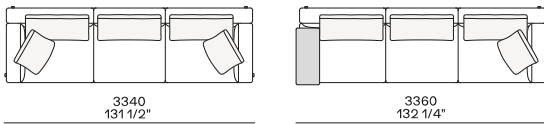

????????? ??? ??????

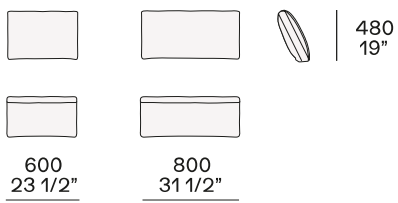

Poliform_sofas_BRERA_cuscini_414px-02

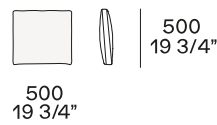

????????????????? ????????

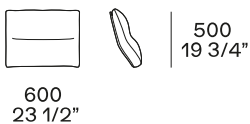

????????? ????????

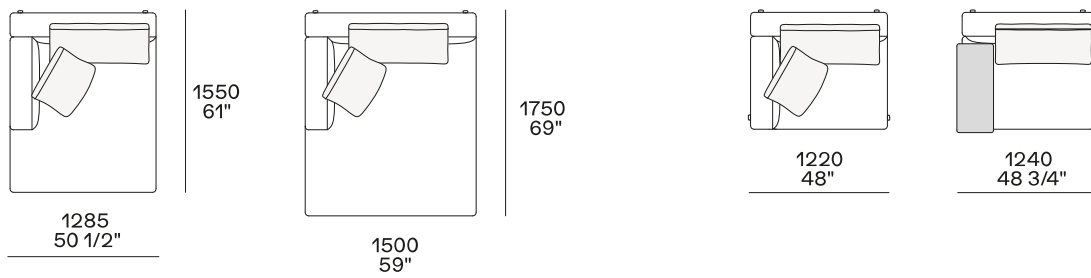

???????????????? ??????

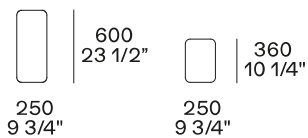

??? ?????????????? Slim ??? ? ?????

?????????? ??????????

?????????? ???????, ??????-???????

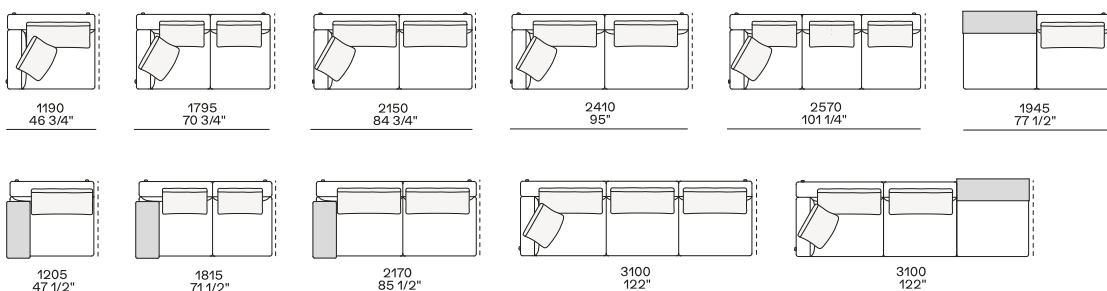

?????????? ??????? ??? ???????????????, ??????-???????

?????????? ??????? ?????????, ??????-???????



?????????? ??????????? ???????, ??????-???????

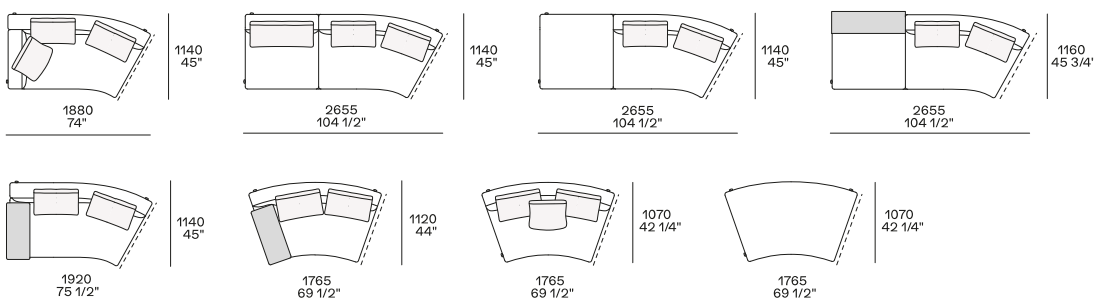

?????????? ?????

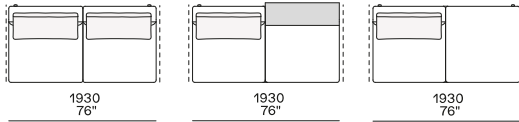
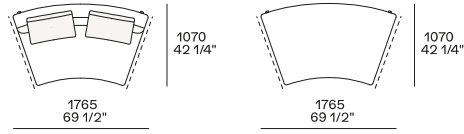
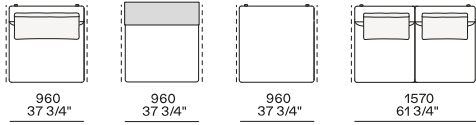

??????? ??????, ?????-?????

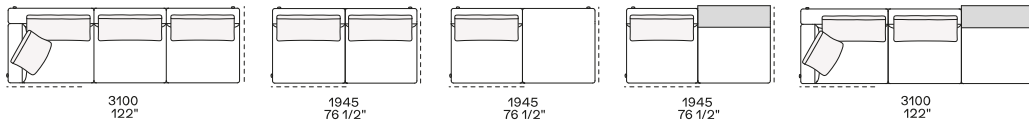
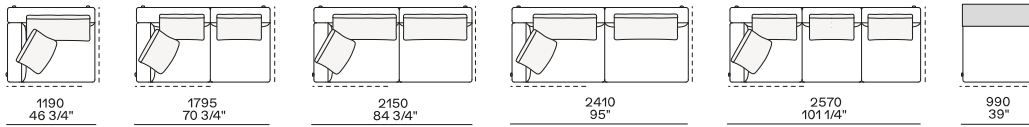

????????? ??????? ??????, ?????-?????

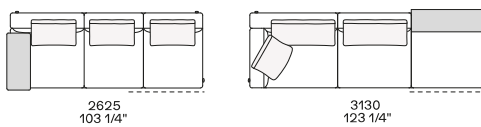
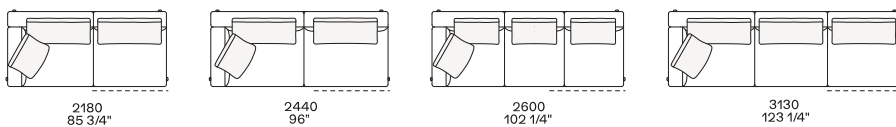
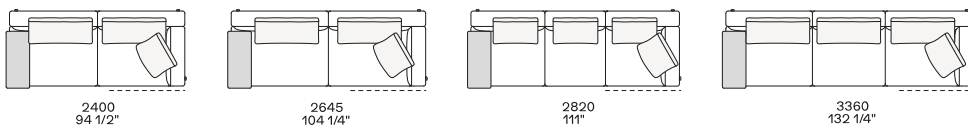
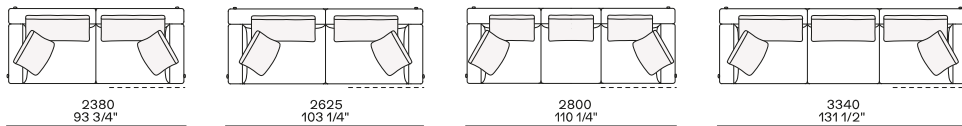

????????? ??????? ?????? ?? ?????????????, ?????-?????

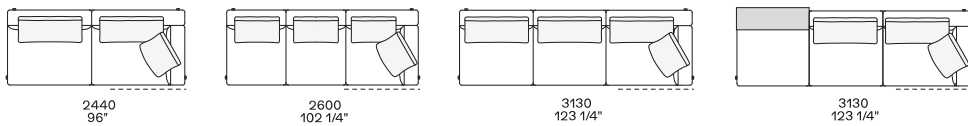

????????? ????????????

????? ? ????? ????????????????

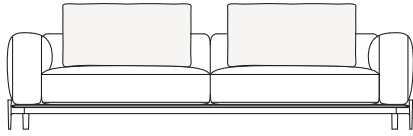

2625
103 1/4"

410
16 1/4"

620
24 1/2"

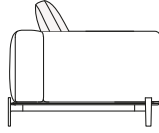

1005
39 1/2"

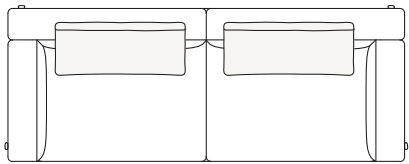

????? ? ??????????????? Slim ? ?????? ?????????????? ????????????????

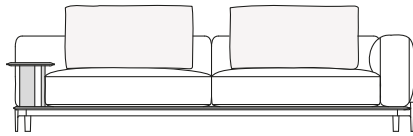

2645
104 1/4"

410
16 1/4"

620
24 1/2"

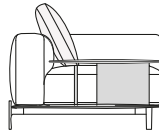

445
17 1/2"

1020
40 1/4"

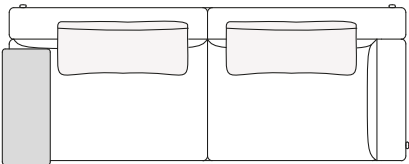

????? ? ?????? ? ????? ???????????????

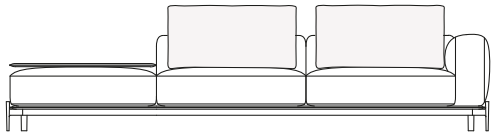

3130
123 1/4"

410
16 1/4"

620
24 1/2"

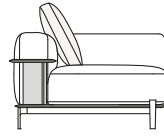

445
17 1/2"

1020
40 1/4"

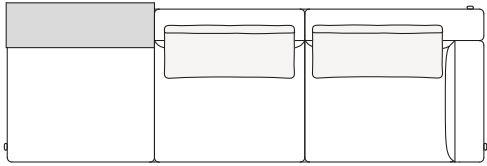

????? ??? ?????????????? ? ? ??????

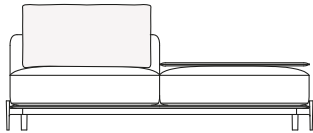

1975
77 3/4"

410
16 1/4"

620
24 1/2"

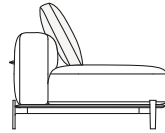

445
17 1/2"

1020
40 1/4"

