



介绍

可自由组合的模块化无缝沙发

木料及其衍生物

不同密度的聚氨酯泡沫

聚氨酯泡沫

不同密度的聚氨酯泡沫

棉质帆布和羽绒

可拆卸织物或皮革

彩绘中密度纤维板

棉质帆布和羽绒

尺寸

左右末端

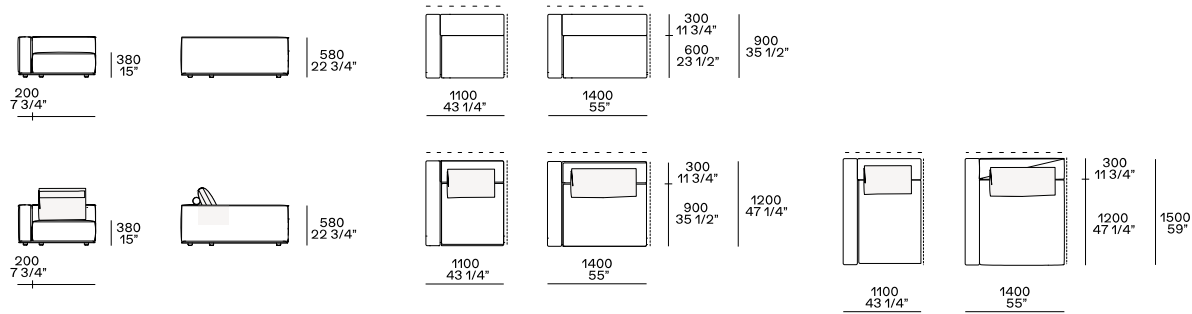

Terminale sx-dx con bracciolo Slim

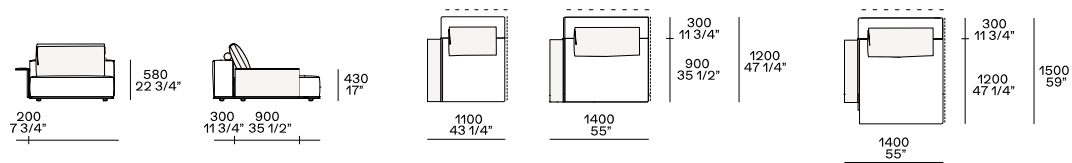

Centrale

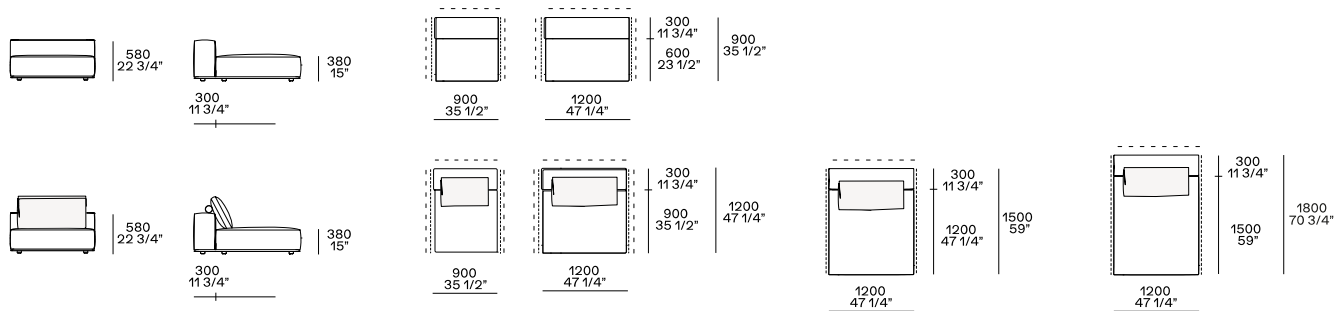

Terminale isola sx-dx

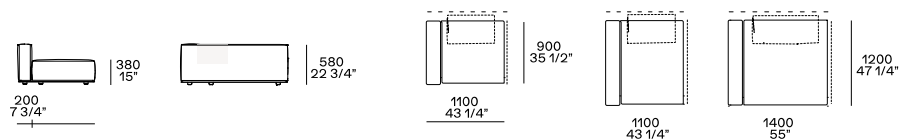

Nelle composizioni bifacciali i cuscini schienale sono appoggiati allo schienale dell' elemento retrostante

Centrale con schienale con mensola

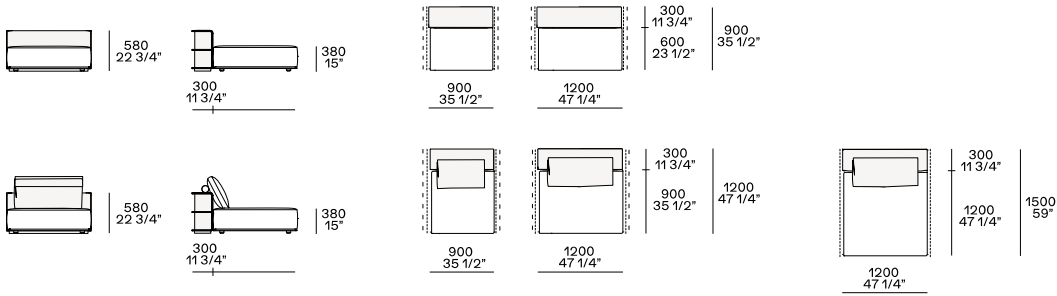

Chaise longue

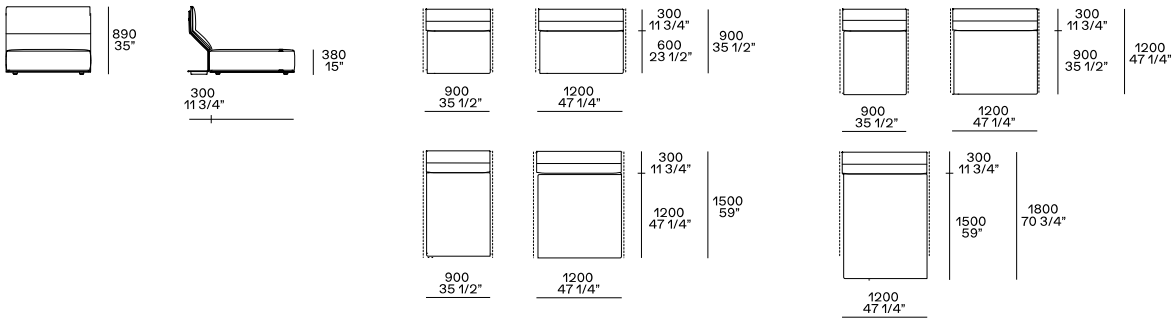

Chaise longue sx-dx con bracciolo Slim

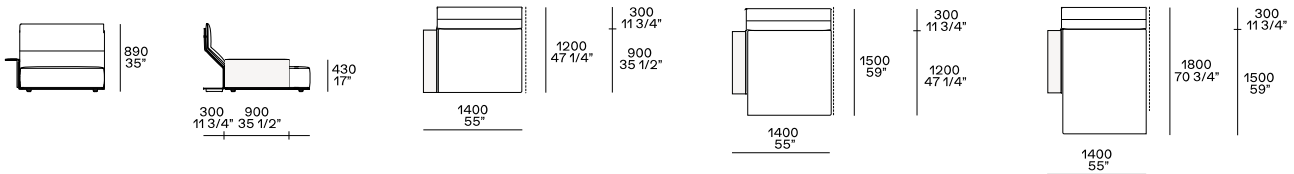

Angolo sx-dx

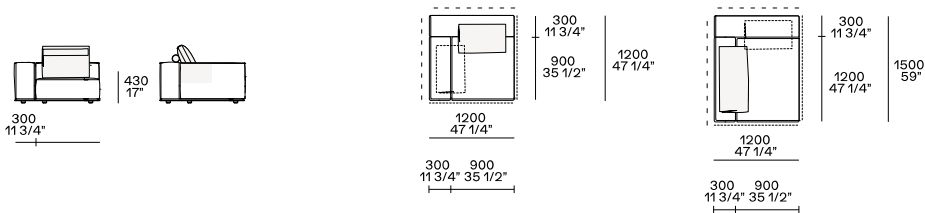

Pouf

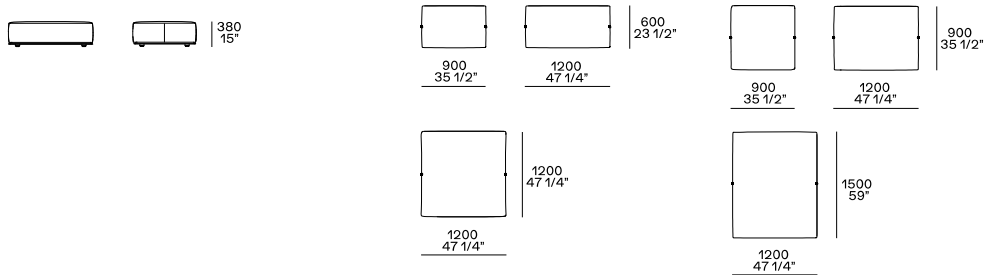

Usò terminale, centrale, angolare e bifacciale su tutti i lati tranne che per il modulo 1200x600 componibile in bifacciale solo su lato lungo

Schienale mobile

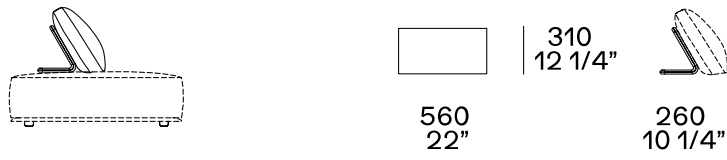

Utilizzabile solo su pouf

Chaise longue

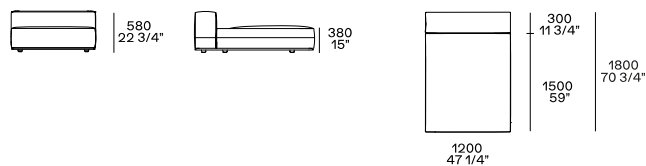

Pouf

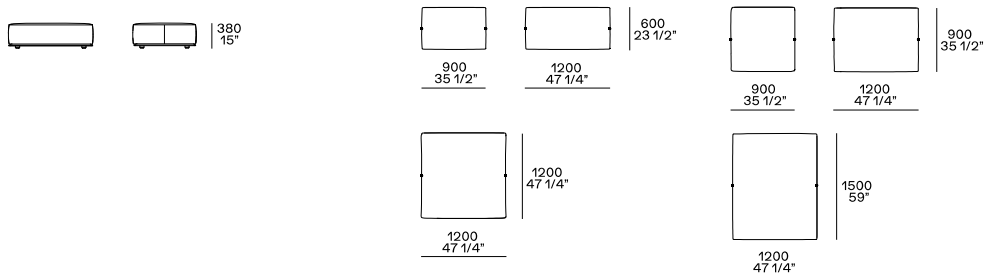

Usò terminale, centrale, angolare e bifacciale su tutti i lati tranne che per il modulo 1200x600 componibile in bifacciale solo su lato lungo

Schienale mobile

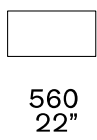
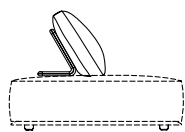

310
12 1/4"



260
10 1/4"

Utilizzabile solo su pouf

Elemento retro divano con mensola

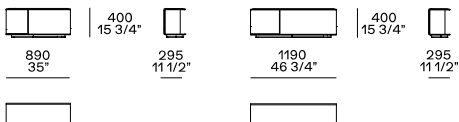

Elemento retro divano con vano a giorno

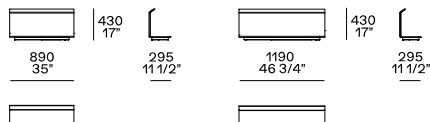

Tavolino retro divano

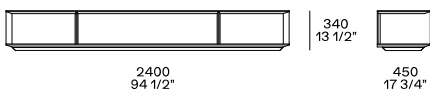
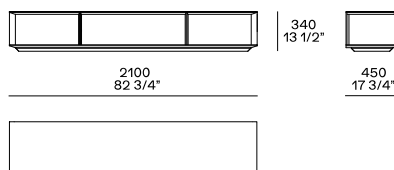
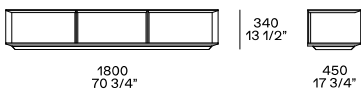

Cassetto opzionale

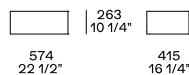

Cuscini schienale con o senza rullo □ 90

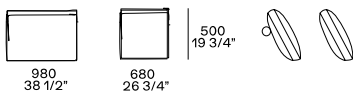

Poggiatesta

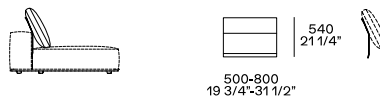

Larghezza 680-980 da abbinare in base alla larghezza degli schienali

Non utilizzabile su pouf, chaise longue, elemento con mensola

Cuscino opzionale comfort



Cuscino opzionale a fascia

