



DESCRIPTION

Typology

Wardrobe

Structure

Panel of wooden particles faced with melamine

STRUCTURE

Components

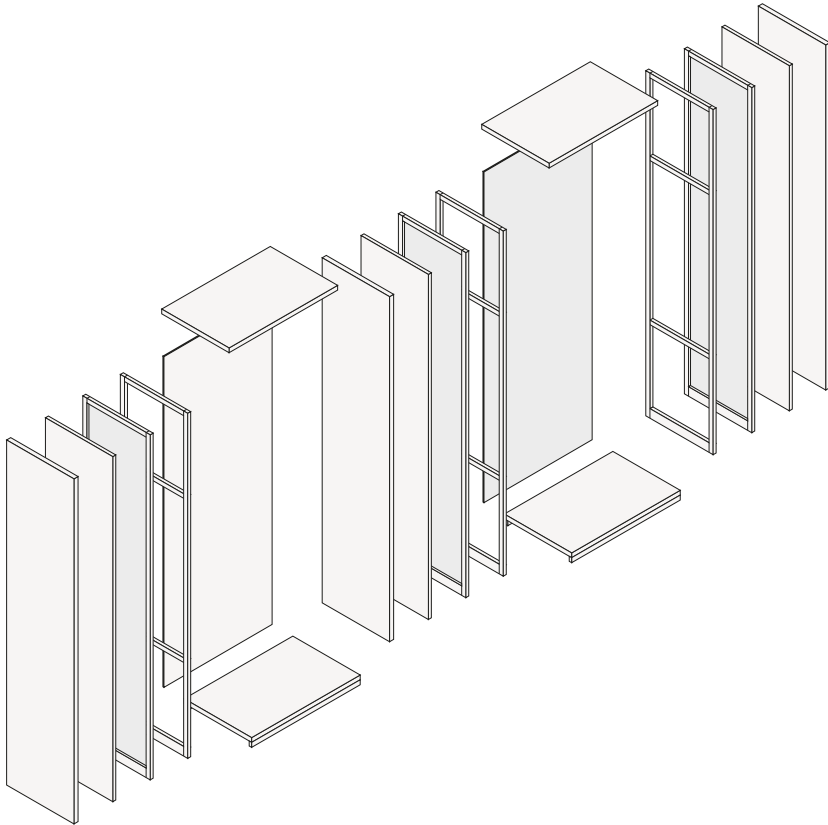

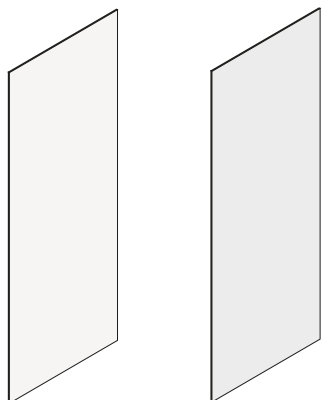
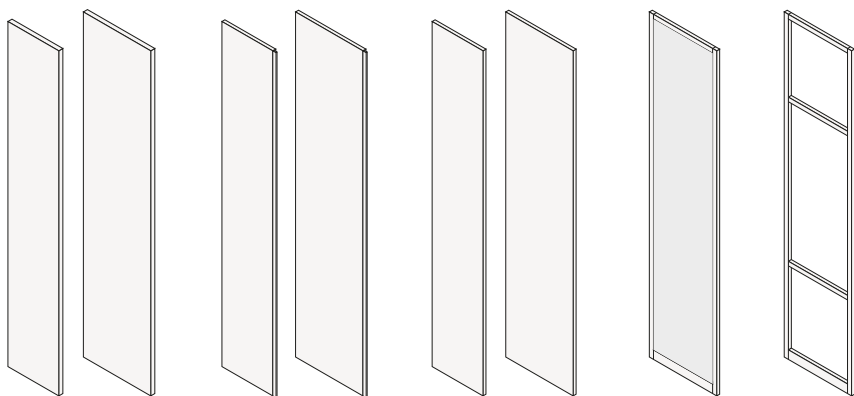
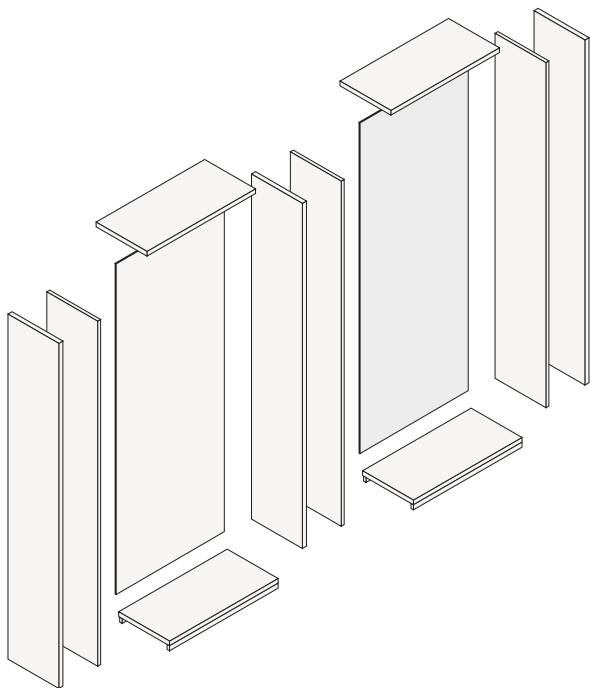

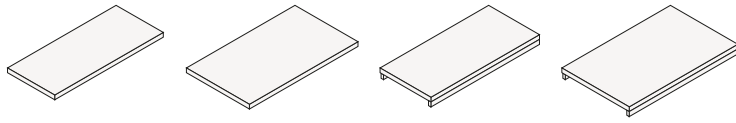

Depth 15 3/4" - thickness 1 1/2"

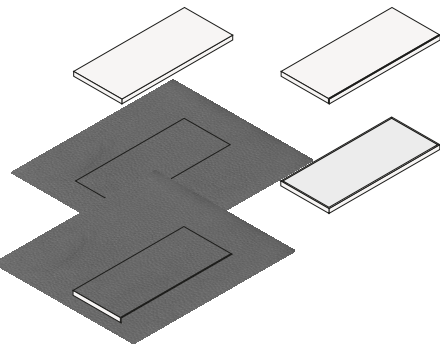

Depth 21 1/2" - thickness 1 1/2"

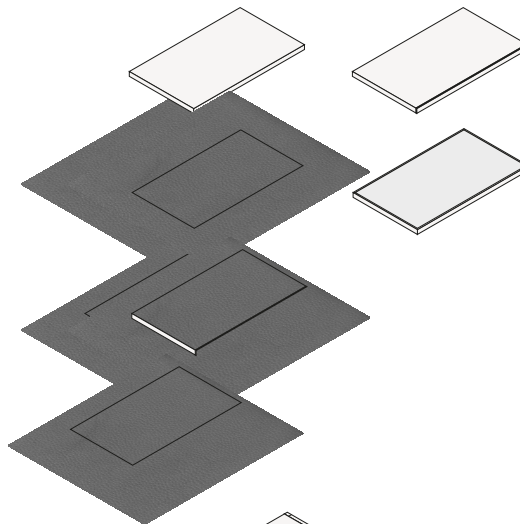

Senzafine - Ubik integration

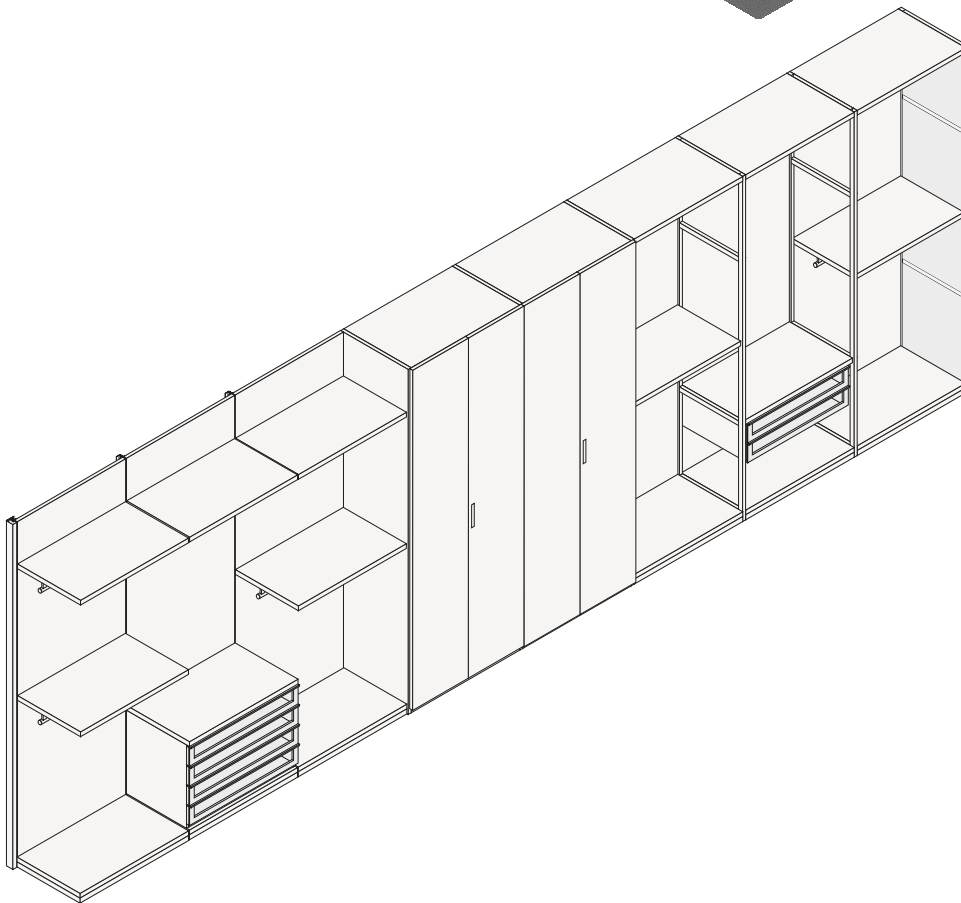

The Senzafine wardrobe and walk-in closet system and the Ubik walk-in closet system have the same modularity in height and share equipment and finishes.

Structure details



Wood side with wood back panel.



Frame side with wood back panel.



Glass side with wood back panel.

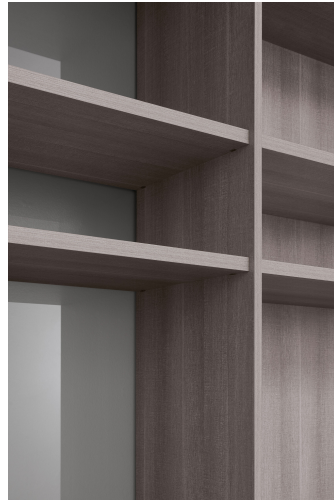

Wood side with wood and glass back panel.



Frame side with glass back panel.



Glass side with glass back panel.



Standard sides drilling for wardrobe and walk-in closet: 3 holes, pitch 2 1/2".



Sides drillings optional for wardrobe and walk-in closet: at shelf height.



Sides drillings optional for wardrobe and walk-in closet: continuous, pitch 2 1/2".

Edges in matching colour



For wardrobes and walk-in closets with all the sides in wood, in melamine 7 finishings, edges of sides, bases and tops in matching colour with the side.

Edges in melamine champagne



For wardrobes and walk-in closets with at least one frame side or glass side mat painted champagne, edges of sides, bases and tops in melamine champagne.

Edges in melamine ardesia



For wardrobes and walk-in closets with at least one frame side or glass side mat painted ardesia, edges of sides, bases and tops in melamine ardesia.

Plinth filler standard



For wardrobe and walk-in closet. Mat painted ardesia or champagne, height 1 1/2".

Optional plinth filler



For walk-in closet and island chests of drawers. Mat painted ardesia or champagne, height 2 3/4".

Cap for base



Available in the colours ardesia or champagne. The perfect installation of every wardrobe is guaranteed by the possibility to level every single column with adjustable feet assembled on the bases, caps are used to hide the adjustable screws.

Profile of lateral side for wardrobe



The profile is in the same finish of the door or, in case of glass door, in the same finish of the doorframe. Optional profile finish for Cover in techno leather and Cover in fabric. Not available in hide.

Hinge



Hinge in ardesia mat painted metal. Standard opening 110°, optional 165°. For all doors of the Senzafine system (except Ego and Fitted doors).

Ego hinge



Hinge in ardesia or champagne mat painted metal, only for Ego door. Standard opening 180°.

Fitted hinge



Hinge in ardesia mat painted metal, only for Fitted glass door. Standard opening 98°.

Special solutions

Leaf corner element



h 76 3/4"-89 1/4"-95 3/4"-102"-114 1/2" w 42 3/4" - d 23"
With leaf door w 18 3/4", opening 165°. Leaf corner element can be equipped with shelves (except glass shelves) and hanging rails.

Sliding corner element



h 89 1/4"-95 3/4"-102"-114 1/2" w 61 3/4" - d 23"
With sliding door w 38 3/4". Sliding corner element can be equipped with shelves (except glass shelves) and hanging rails.

Open corner element



h 76 3/4"-89 1/4"-95 3/4"-102"-114 1/2" w 25 3/4" - d 23"
With leaf door w 25 1/4" + fixed door. Corner open element can be equipped with shelves and hanging rails.

Double end unit



h 76 3/4"-89 1/4"-95 3/4"-102"-114 1/2" w 33 1/2" - d 23"
With leaf doors w 18 3/4". Double end unit can be equipped with melamine shelves and hanging rails.

Single end unit



h 76 3/4"-89 1/4"-95 3/4"-102"-114 1/2" w 15" - d 23"
With leaf door w 18 3/4". Single end unit can be equipped with melamine shelves.

Opening door as filler

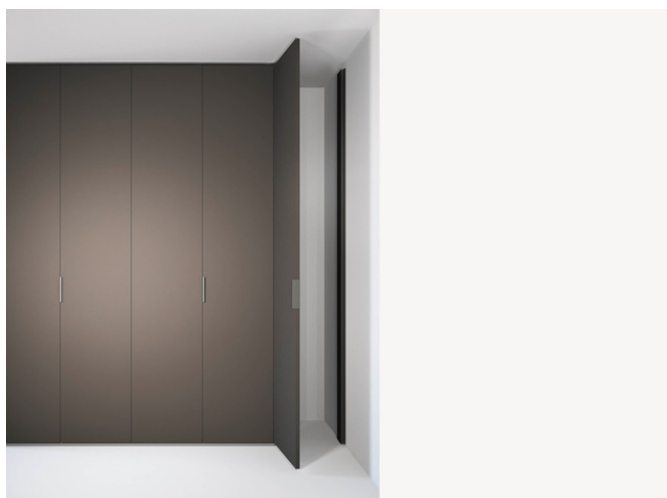

Door supplied with aluminium mat lacquered ardesia or champagne plinth, fixed to the door, right or left hinges, wall stop profile. It can be mounted flush with the door or backward by doubling the special side.

Filler

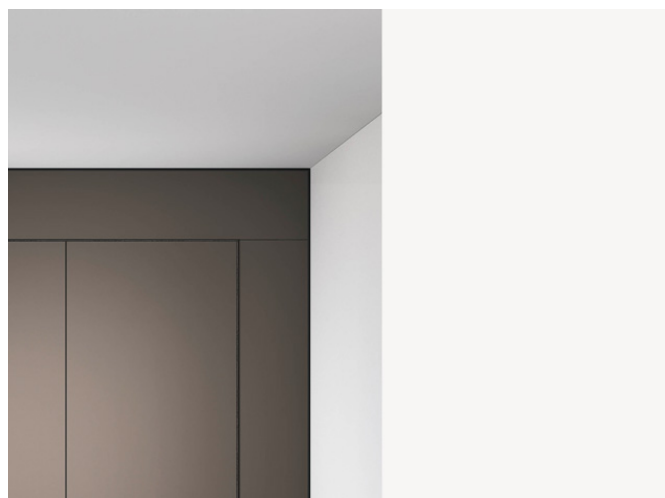

Flush to structure horizontal/vertical, width from 1 1/4" to 11 3/4" height till 114 1/2". Flush to the door, width from 1 1/4" to 11 3/4".



Bridge units with leaf doors, available in 4 heights, with the models: Club, Graffiti, Sand, Canvas, Silk, Skin, New Entry, Stratus. Only available between two wooden sides; with two or more bridge units one next to the other a reinforced bridge bar is available. Maximum width mm 87 3/4" (below bridge).

Cut on measure



Cuts in height, width and depth are possible. In reference to the possible limitations of some doors reductions, see pages 130-163. The solution with mansard doors is possible with the models Club, Graffiti, Sand, Canvas, Silk, Skin, New Entry and Plus.

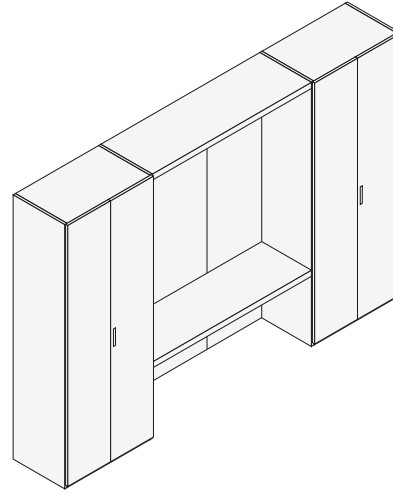
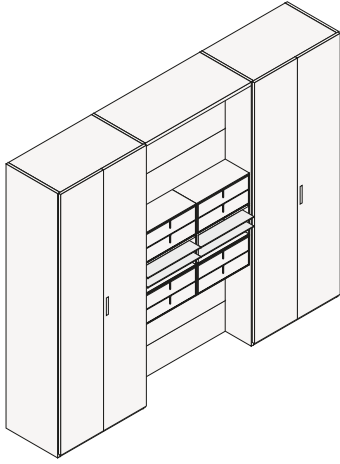

Wardrobe compositions with integrated day system Quid. Wall panelling Quid accessorized with open display cases, wooden or glass shelves, flap door or small drawers in hide. Suspended thick shelf and wall panelling in mirror also available for Vanity solutions. Arrangement for wall panelling fixing with advanced back panel w 23 1/2"-35 1/2"-47 1/4". Arrangement for Vanity solution with wall mounted wall panelling w 35 1/2"-47 1/4"-70 3/4"-82 3/4"- 94 1/2"-106 1/4".

Wardrobe compositions with integrated day system Code. Accessorized wall panelling with backlit thick shelf.

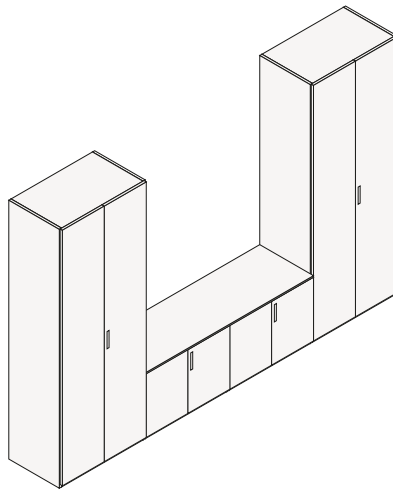
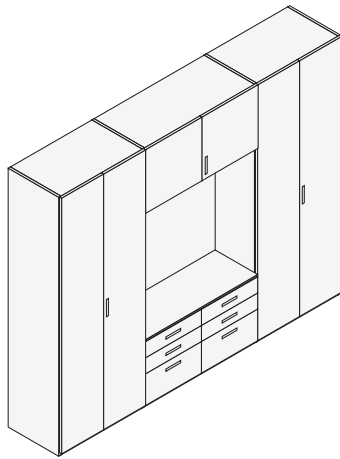

Available with doors: Club, Sand, Silk and New Entry.

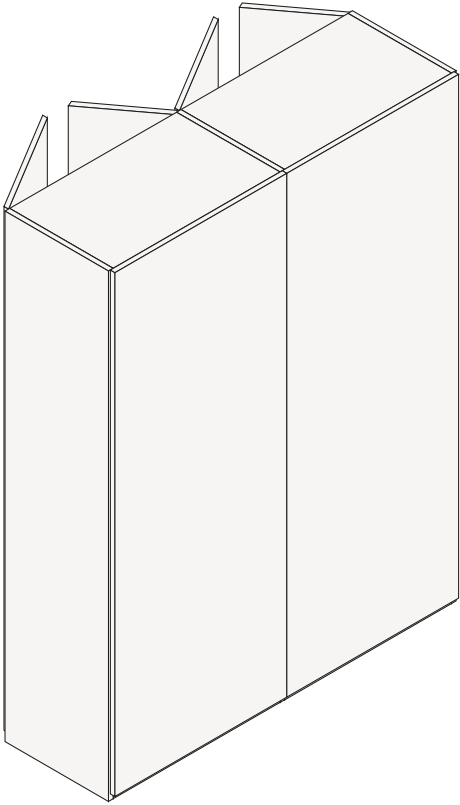

The exposed back panel of the wardrobe is finished with special panels till the floor.

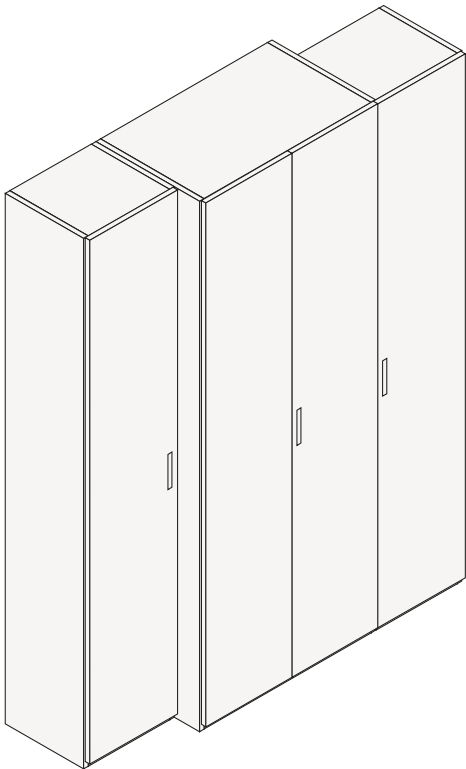

Columns without base must be always between two columns with base.

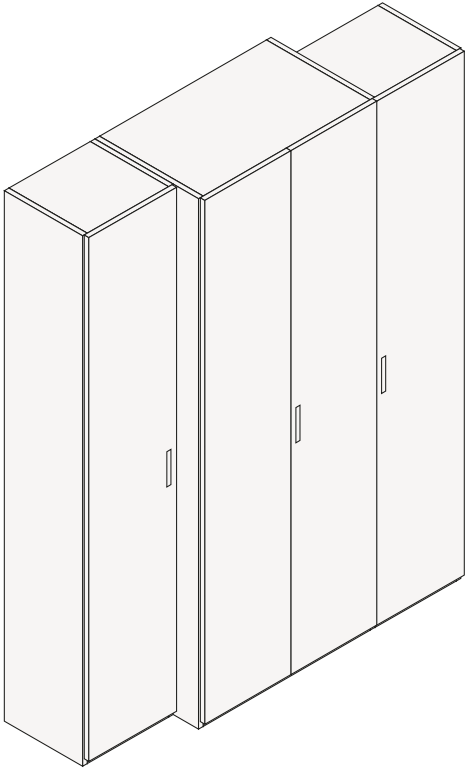

It is possible to realize wardrobes with columns of depth 17 1/4" combined with columns of depth 23", with doors alignment to the front or units rear alignment with double lateral side.

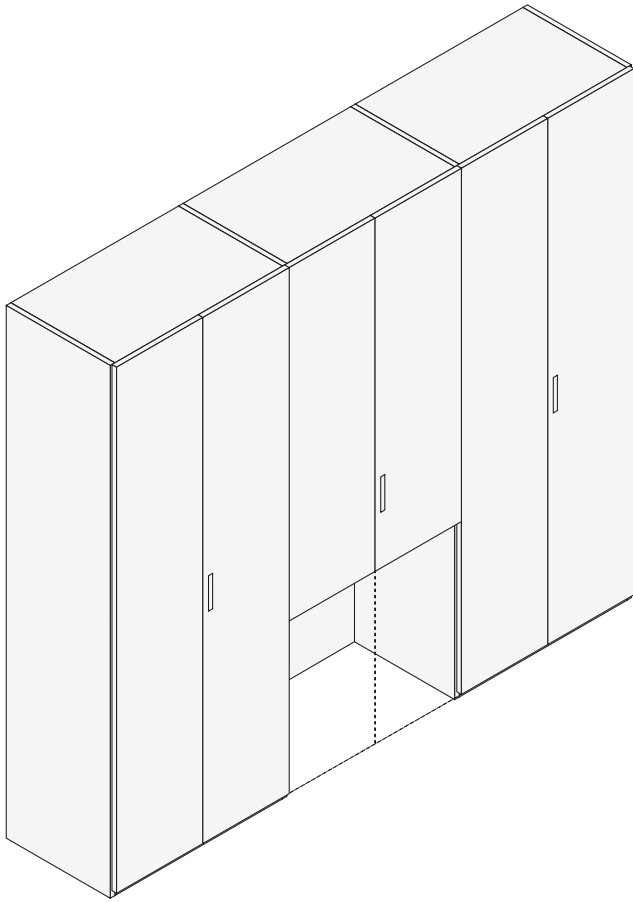

The units can be realized with open compartment without base and with back panel till the floor or with doors till the floor and partial back panel.

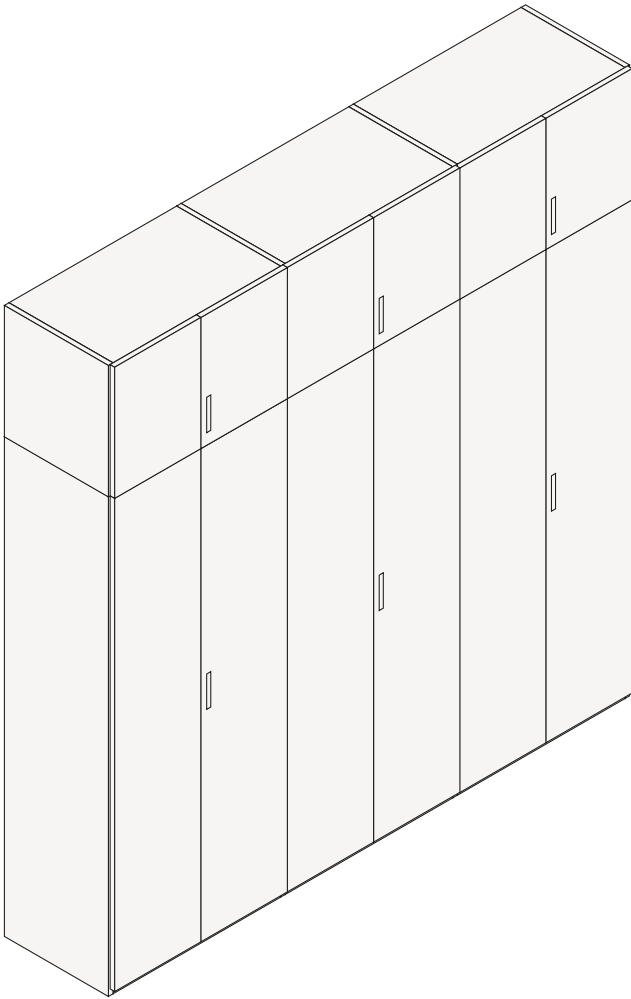

Available with doors: Club, Sand, Silk and New Entry. An upper unit is superimposed to the unit in standard height; the leaf door can be standard or customized in height.

Structure finishes



Back panel: elm melamine
Equipment: elm melamine
Techno cover: 05 latte, 06 nocciola
Metal parts: mat champagne



Back panel: elm melamine
Equipment: elm melamine
Techno cover: 05 latte, 06 nocciola
Metal parts: mat ardesia



Back panel: skin melamine 94 latte
Equipment: elm melamine
Technocover: 05 latte, 06 nocciola
Metal parts: mat champagne



Back panel and drawers: canvas
beige Equipment: elm melamine
Techno cover: 05 latte, 06 nocciola
Metal parts: mat champagne



Back panel and drawers: roller latte
Equipment: elm melamine
Techno cover: 05 latte, 06 nocciola
Metal parts: mat champagne



Back panel: canvas grigio
Equipment: elm melamine
Techno cover: 01 elefante
Metal parts: mat ardesia



Back panel: ardesia melamine
Equipment: elm melamine
Techno cover: 01 elefante
Metal parts: mat ardesia



Back panel and drawers: roller ardesia
Equipment: elm melamine
Techno cover: 01 elefante
Metal parts: mat ardesia



Back panel: walnut c. melamine
Equipment: walnut c. melamine
Techno cover: 05 latte, 06 nocciola
Metal parts: mat champagne



Back panel: walnut c. melamine
Equipment: walnut c. melamine
Techno cover: 01 elefante
Metal parts: mat ardesia



Back panel: skin melamine 94 latte
Equipment: walnut c. melamine
Techno cover: 05 latte, 06 nocciola
Metal parts: mat champagne



Back panel and drawers: canvas beige
Equipment: walnut c. melamine
Techno cover: 05 latte, 06 nocciola
Metal parts: mat champagne



Back panel and drawers: roller latte
Equipment: walnut c. melamine
Techno cover: 05 latte, 06 nocciola
Metal parts: mat champagne



Back panel: canvas grigio
Equipment: walnut c. melamine
Techno cover: 01 elefante
Metal parts: mat ardesia



Back panel: ardesia melamine
Equipment: walnut c. melamine
Techno cover: 01 elefante
Metal parts: mat ardesia



Back panel and drawers: roller ardesia
Equipment: walnut c. melamine
Techno cover: 01 elefante
Metal parts: mat ardesia



Back panel: cenere oak melamine
Equipment: cenere oak melamine
Techno cover: 05 latte, 01 elefante
Metal parts: mat ardesia



Back panel: ardesia melamine
Equipment: cenere oak melamine
Techno cover: 05 latte, 01 elefante
Metal parts: mat ardesia



Back panel and drawers: roller ardesia
Equipment: cenere oak melamine
Techno cover: 05 latte, 01 elefante
Metal parts: mat ardesia



Back panel and drawers: canvas beige
Equipment: cenere oak melamine
Techno cover: 05 latte, 01 elefante
Metal parts: mat ardesia



Back panel and drawers: canvas beige
Equipment: cenere oak melamine
Techno cover: 05 latte, 01 elefante
Metal parts: mat champagne



Back panel and drawers: roller latte
Equipment: cenere oak melamine
Techno cover: 05 latte, 01 elefante
Metal parts: mat champagne



Back panel: canvas grigio
Equipment: cenere oak melamine
Techno cover: 05 latte, 01 elefante
Metal parts: mat ardesia



Back panel: cenere oak melamine
Equipment: cenere oak melamine
Techno cover: 05 latte, 01 elefante
Metal parts: mat champagne



Back panel: skin melamine 48 visone
Equipment: cenere oak melamine
Techno cover: 05 latte, 01 elefante
Metal parts: mat champagne



Back panel: spessart oak melamine
Equipment: spessart oak melamine
Techno cover: 06 nocciola, 02 moro
Metal parts: mat champagne



Back panel: spessart oak melamine
Equipment: spessart oak melamine
Techno cover: 06 nocciola, 01 elefante
Metal parts: mat ardesia



Back panel: canvas grigio
Equipment: spessart oak melamine
Techno cover: 06 nocciola, 01 elefante
Metal parts: mat ardesia



Back panel: ardesia melamine
Equipment: spessart oak melamine
Techno cover: 06 nocciola, 01 elefante
Metal parts: mat ardesia



Back panel and drawers: roller ardesia
Equipment: spessart oak melamine
Techno cover: 06 nocciola, 01 elefante
Metal parts: mat ardesia



Back panel: skin melamine 06 nocciola
Equipment: spessart oak melamine
Techno cover: 06 nocciola, 02 moro
Metal parts: mat champagne



Back panel and drawers: canvas beige
Equipment: spessart oak melamine
Techno cover: 05 latte, 01 elefante
Metal parts: mat champagne



Back panel and drawers: roller latte
Equipment: spessart oak melamine
Techno cover: 05 latte, 01 elefante
Metal parts: mat champagne



Back panel: canvas beige
Equipment: canvas beige
Techno cover: 05 latte, 06 nocciola
Metal parts: mat champagne



Back panel: canvas beige
Equipment: canvas beige
Techno cover: 05 latte, 01 elefante
Metal parts: mat ardesia



Back panel and drawers: roller latte
Equipment: canvas beige
Techno cover: 05 latte, 01 elefante
Metal parts: mat ardesia



Back panel and equipment: canvas beige
Drawers: elm melamine
Techno cover: 05 latte, 06 nocciola
Metal parts: mat champagne



Back panel and drawers: elm melamine
Equipment: canvas beige
Techno cover: 05 latte, 06 nocciola
Metal parts: mat champagne



Back panel: walnut c. melamine
Equipment: canvas beige
Techno cover: 05 latte, 06 nocciola
Metal parts: mat champagne



Back panel: cenere oak melamine
Equipment: canvas beige
Techno cover: 05 latte, 01 elefante
Metal parts: mat champagne



Back panel: spessart oak melamine
Equipment: canvas beige
Techno cover: 05 latte, 01 elefante
Metal parts: mat ardesia



Back panel: ardesia melamine
Equipment: canvas beige
Techno cover: 05 latte, 01 elefante
Metal parts: mat ardesia



Back panel and drawers: cenere oak melamine
Equipment: canvas beige
Techno cover: 05 latte, 01 elefante
Metal parts: mat ardesia



Back panel: canvas grigio
Equipment: canvas grigio
Techno cover: 05 latte, 01 elefante
Metal parts: mat ardesia



Back panel: ardesia melamine
Equipment: canvas grigio
Techno cover: 05 latte, 01 elefante
Metal parts: mat ardesia



Back panel and drawers: ardesia melamine
Equipment: canvas grigio
Techno cover: 05 latte, 01 elefante
Metal parts: mat ardesia



Back panel: spessart oak melamine
Equipment: canvas grigio
Techno cover: 05 latte, 01 elefante
Metal parts: mat ardesia



Back panel and drawers: spessart oak melamine
Equipment: canvas grigio
Techno cover: 05 latte, 01 elefante
Metal parts: mat ardesia



Back panel: canvas grigio
Equipment: canvas grigio
Techno cover: 01 elefante
Metal parts: mat champagne



Back panel: elm melamine
Equipment: canvas grigio
Techno cover: 01 elefante
Metal parts: mat ardesia



Back panel: walnut c. melamine
Equipment: canvas grigio
Techno cover: 01 elefante
Metal parts: mat ardesia



Back panel: cenere oak melamine
Equipment: canvas grigio
Techno cover: 01 elefante
Metal parts: mat ardesia



Back panel: ardesia melamine
Equipment: ardesia melamine
Techno cover: 05 latte, 01 elefante
Metal parts: mat ardesia



Back panel: skin melamine 01 elefante
Equipment: ardesia melamine
Techno cover: 05 latte, 01 elefante
Metal parts: mat ardesia



Back panel and drawers: roller ardesia
Equipment: ardesia melamine
Techno cover: 05 latte, 01 elefante
Metal parts: mat ardesia



Back panel and drawers: canvas grigio
Equipment: ardesia melamine
Techno cover: 05 latte, 01 elefante
Metal parts: mat ardesia



Back panel: walnut c. melamine
Equipment: ardesia melamine
Techno cover: 05 latte, 01 elefante
Metal parts: mat ardesia



Back panel: cenere oak melamine
Equipment: ardesia melamine
Techno cover: 05 latte, 01 elefante
Metal parts: mat ardesia

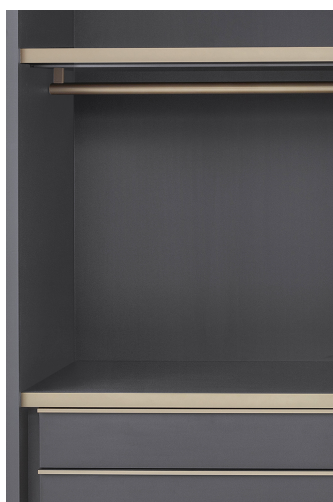

Back panel: ardesia melamine
Equipment: ardesia melamine
Techno cover: 06 nocciola, 01 elefante
Metal parts: mat champagne



Back panel: elm melamine
Equipment: ardesia melamine
Techno cover: 06 nocciola, 01 elefante
Metal parts: mat ardesia



Back panel: spessart oak melamine
Equipment: ardesia melamine
Techno cover: 06 nocciola, 01 elefante
Metal parts: mat ardesia

EQUIPMENTS

Inner organisation

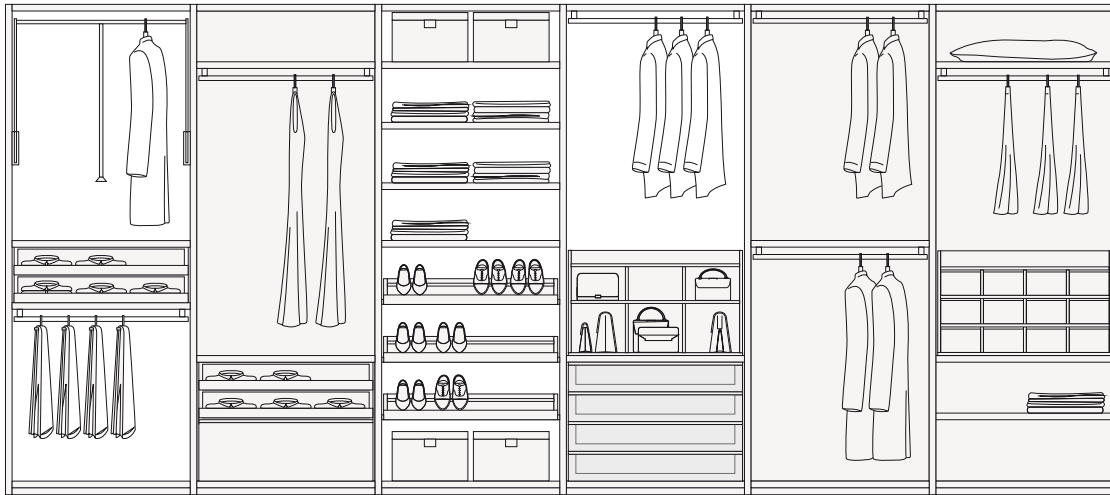
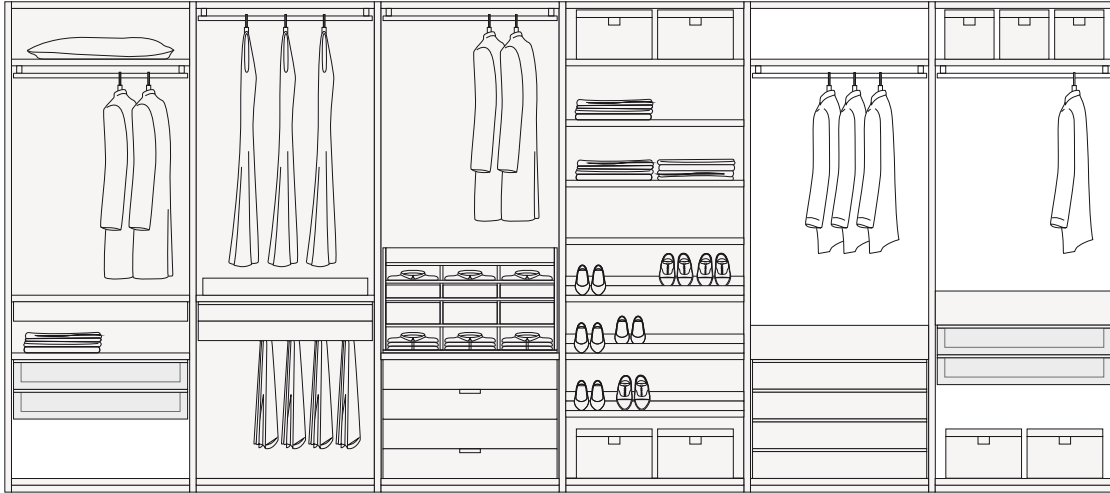

2590
102"

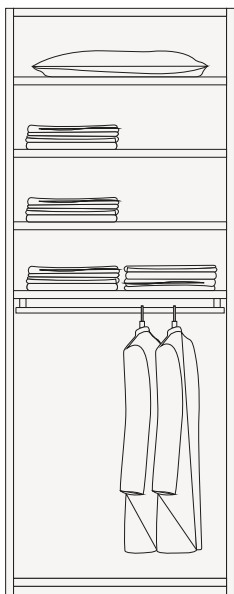
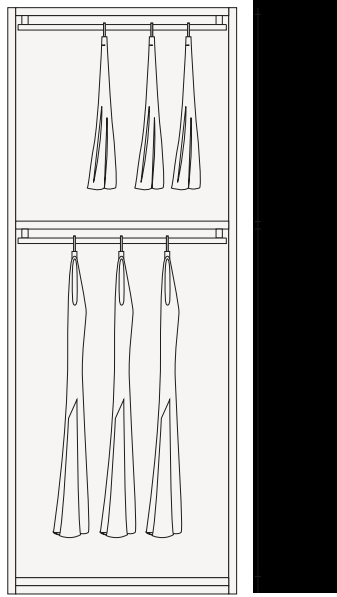
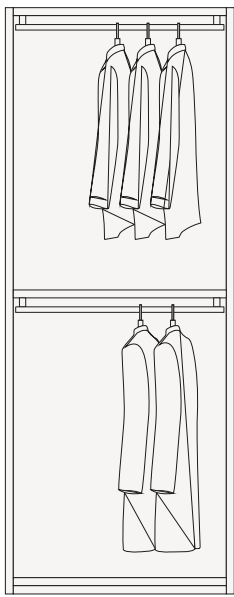

1236
48 3/4"

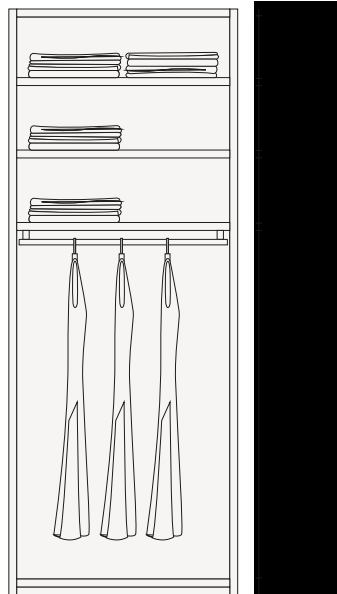

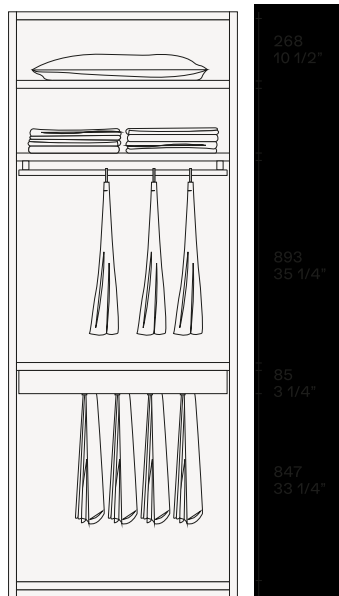
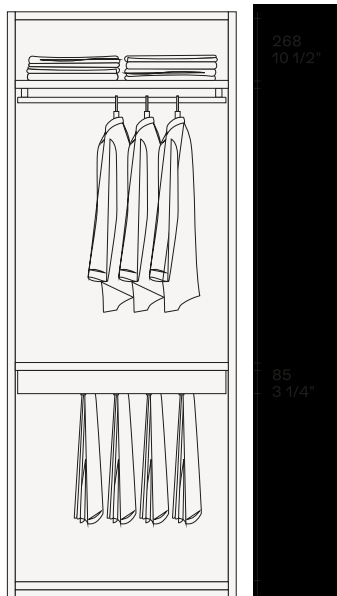
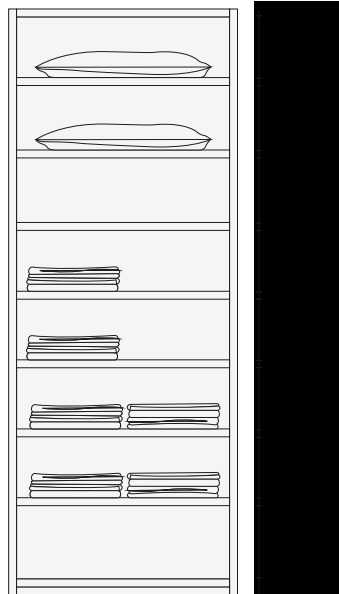
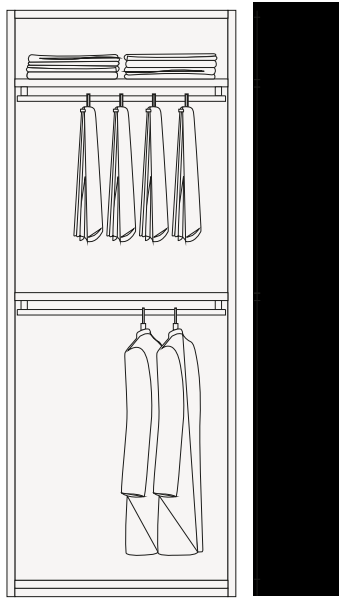

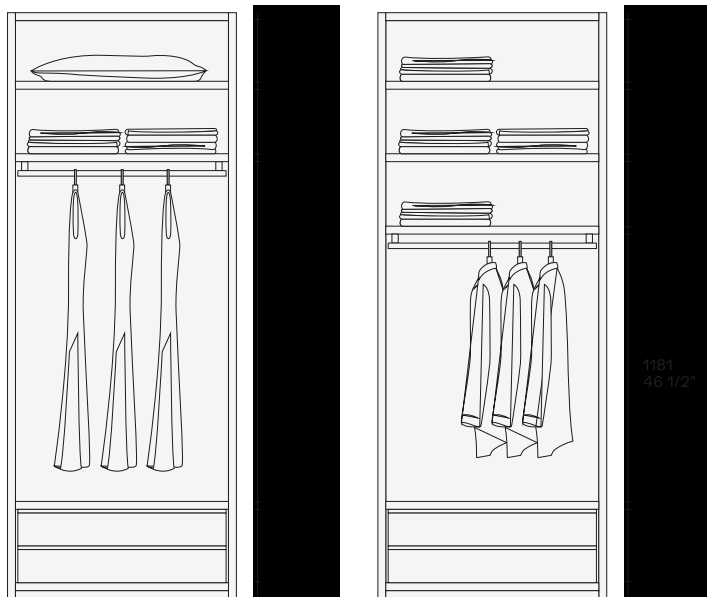
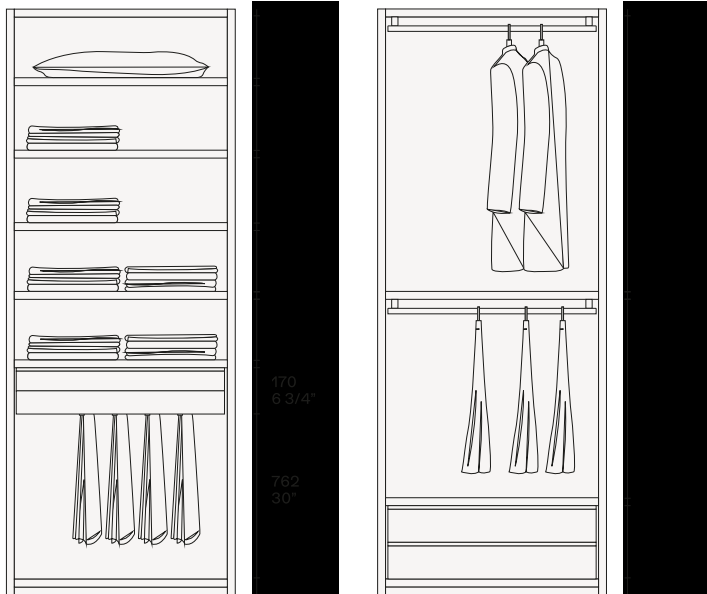

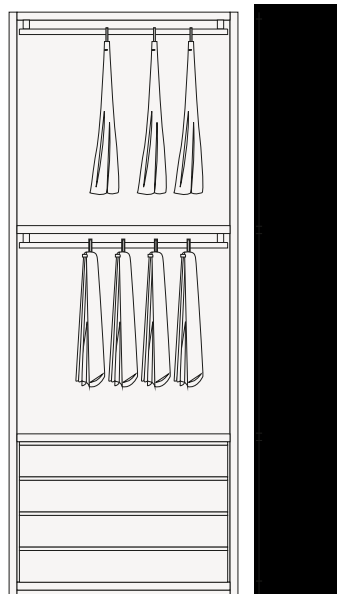
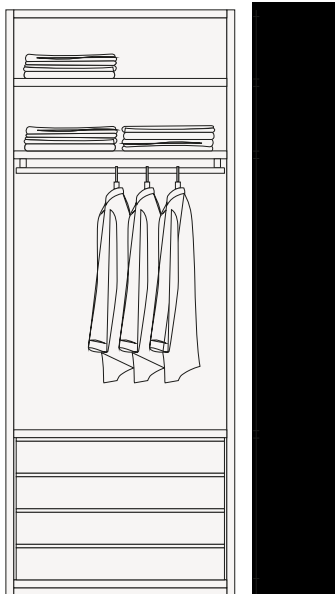
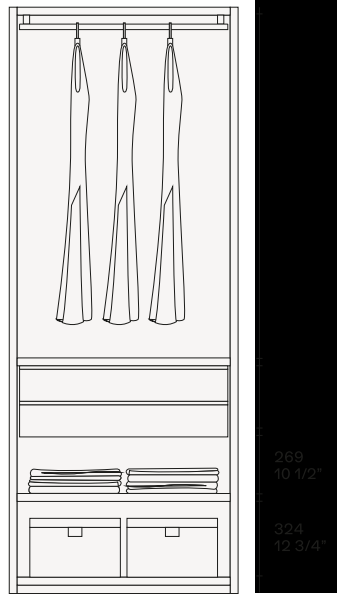
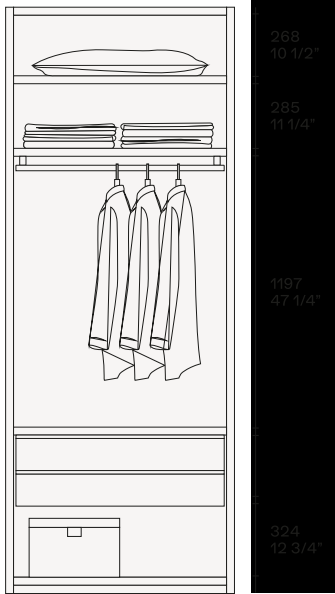

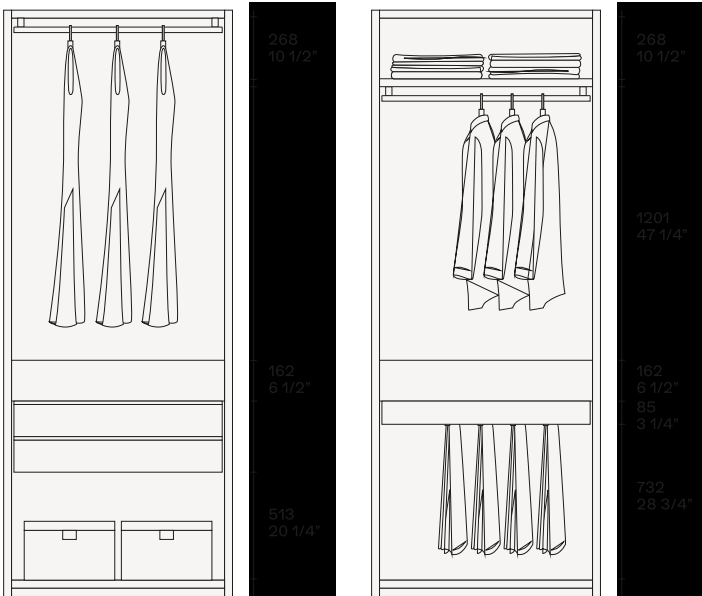
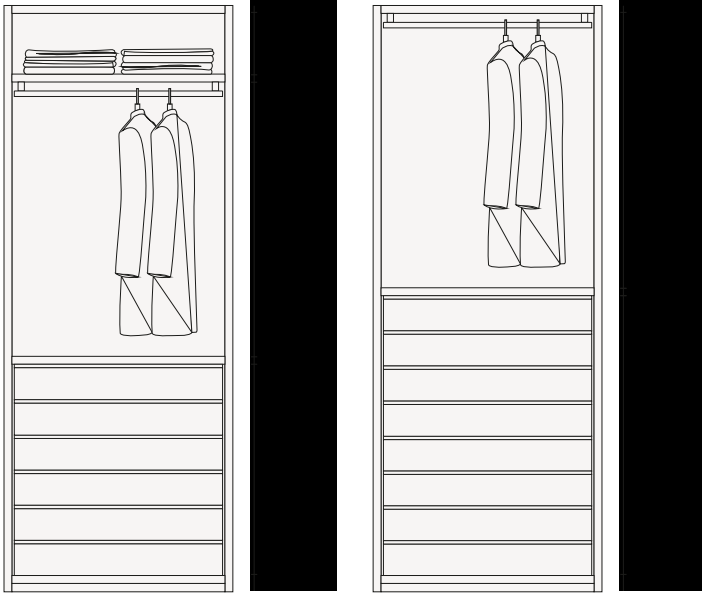

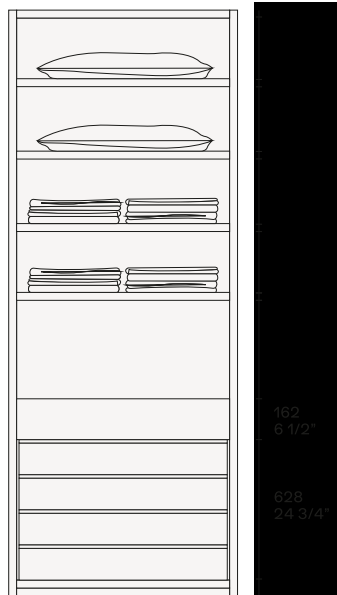
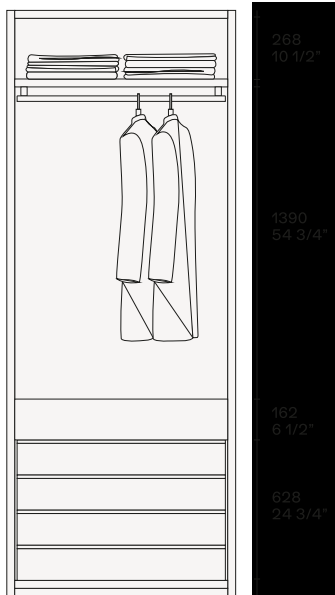
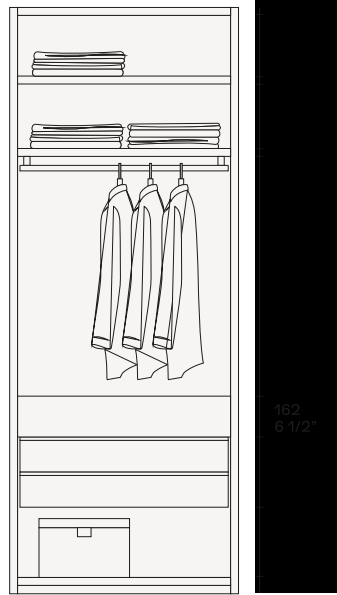
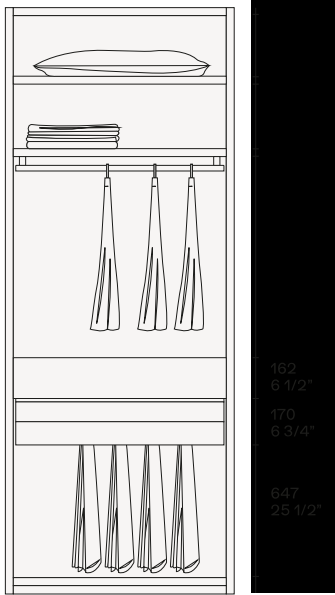

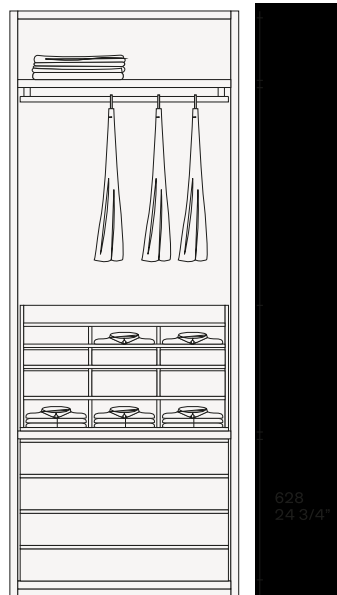
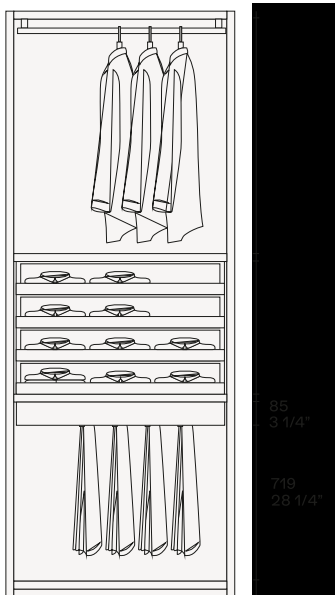
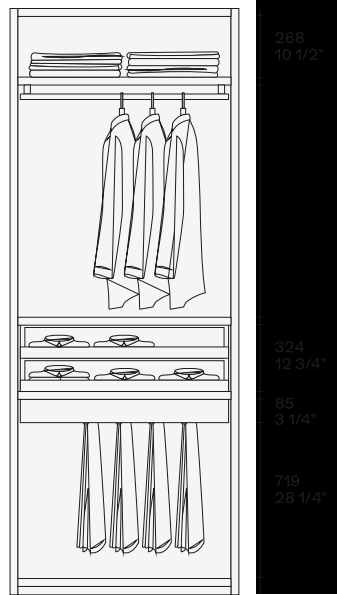
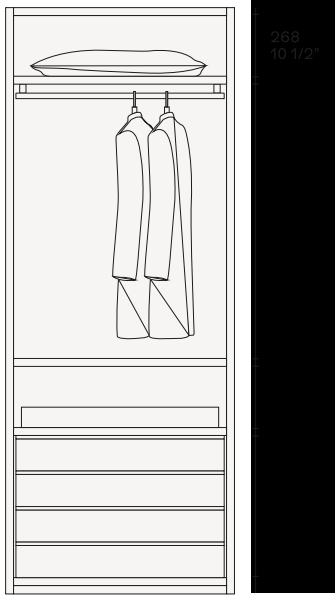

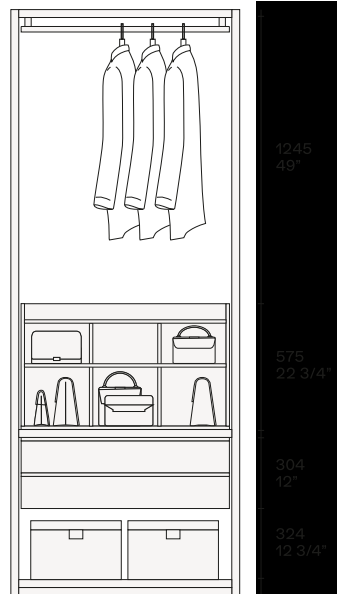
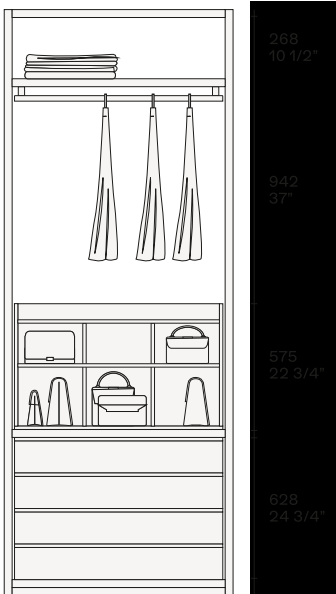
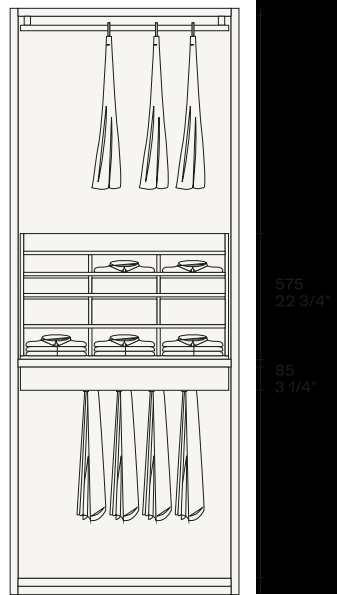
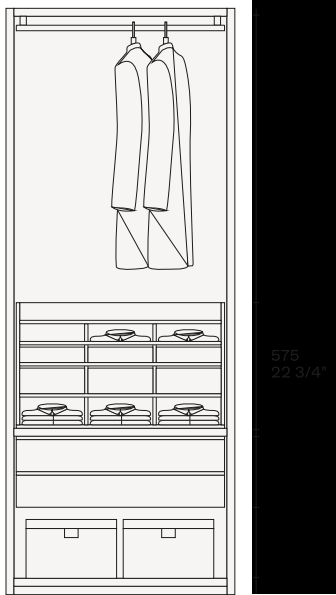

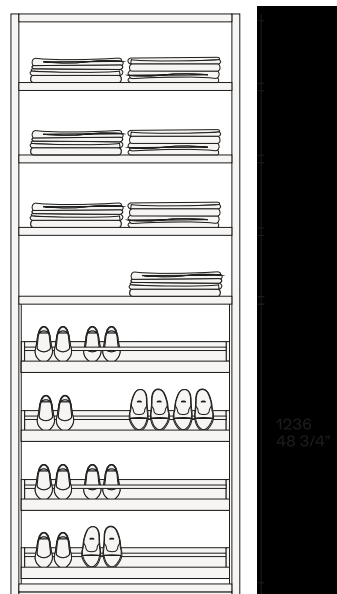
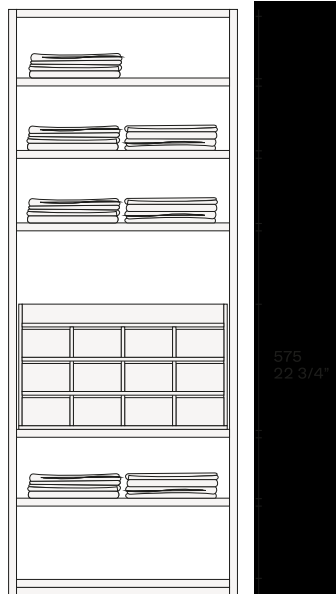
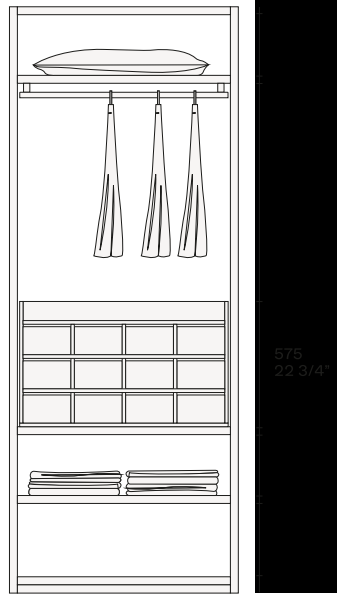
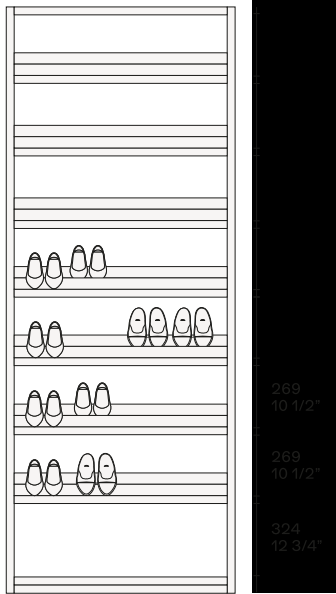

Equipment finishes

Elm melamine



Available for shelves and for all types of boxes, trays and special containers.

Walnut melamine c.



Disponibile per scaffali e per tutti i tipi di scatole, vassoi e contenitori speciali.

Cenere oak melamine



Available for shelves and for all the drawers typologies, trays and storages.

Spessart oak melamine



Available for shelves and for all types of boxes, trays and special containers.

Melamine beige canvas



Available for shelves and for all types of boxes, trays and special containers.

Gray canvas melamine



Available for shelves and for all types of boxes, trays and special containers.

Slate melamine



Available for shelves and for all types of boxes, trays and special containers.

Milk roller methacrylate



Available for shelves and for all types of boxes, trays and special containers.

Slate methacrylate roller



Available for shelves and for all types of boxes, trays and special containers.

Shelves and chests of drawers tops



Melamine shelves and chests of drawers tops. Melamine available in 7 finishings. Thickness 1 1/2", shelves depths 15 3/4" and 21 1/2", chests of drawers tops depth 21 1/2".

Melamine with painted front



Melamine shelves and chests of drawers tops with front in aluminium mat painted ardesia or champagne. Melamine available in 7 finishings. Thickness 1 1/2", shelves depths 15 3/4" and 21 1/2", chests of drawers tops depth 21 1/2".

Techno leather with painted frame



Techno leather in 4 colours shelves and chests of drawers tops with frame in aluminium mat painted ardesia or champagne and underside finishing in ardesia melamine. We suggest using these shelves only up to height 64 1/4". Thickness 1 1/2", shelves depths 15 3/4" and 21 1/2", chest of drawers tops depth 21 1/2".

Techno leather with painted front



Techno leather in 4 colours shelves and chests of drawers tops with front in aluminium mat painted ardesia or champagne and underside finishing in ardesia melamine. We suggest using these shelves only up to height 64 1/4". Thickness 1 1/2", shelves depths 15 3/4" and 21 1/2", chest of drawers tops depth 21 1/2".

Techno cover options



05 latte

Shelves and chests of drawers tops in techno leather 05 latte with frame in aluminium mat painted ardesia or champagne. Underside finishing in ardesia melamine.

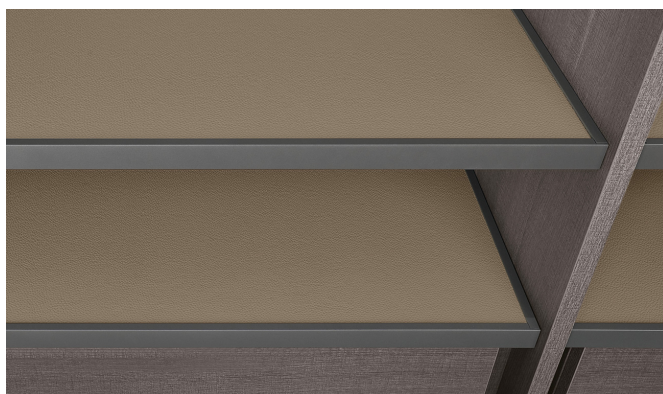

06 nocciola

Shelves and chests of drawers tops in techno leather 06 nocciola with frame in aluminium mat painted ardesia or champagne. Underside finishing in ardesia melamine.



01 elefante

Shelves and chests of drawers tops in techno leather 01 elefante with frame in aluminium mat painted ardesia or champagne. Underside finishing in ardesia melamine.



02 moro

Shelves and chests of drawers tops in techno leather 02 moro with frame in aluminium mat painted ardesia or champagne. Underside finishing in ardesia melamine.

Glass with painted frame



Fumé glass shelves with frame in aluminium mat painted ardesia or champagne. Thickness 1 1/2", shelf depth 15 3/4" and 21 1/2".

Hangers elements

Champagne hanging rail



Mat painted champagne finishing. Foreseen to be fixed on the top or inner shelves. Available in 6 column widths provided by the Senzafine system also for double end units and corner units. Hanging rails cannot be used with shelf depth 15 3/4".

Ardesia hanging rail



Mat painted ardesia finishing. Foreseen to be fixed on the top or inner shelves. Available in 6 column widths provided by the Senzafine system also for double end units and corner units. Hanging rails cannot be used with shelf depth 15 3/4".

Techno cover hanging rail



Covered in techno lcover 4 colours and mat painted ardesia or champagne.
Foreseen to be fixed on the top or inner shelves. Available in 6 column widths provided by the Senzafine system also for double end units and corner units.
Hanging rails cannot be used with shelf depth 15 3/4".

Hanging rail for glass shelf



Hanging rail in champagne, ardesia, techno cover finishings.



Mat painted ardesia finishing. Max capacity 10 Kg. Foreseen to be fixed on the wooden sides. Not available with frame side or glass side. For units width 18"-24 1/4"-30 3/4"- 37" - h 35".

Clothes hanger with trousers hanger and skirts hanger with pliers



Finishing: ardesia painted beech. 4 pieces package.

Trousers hanger and skirts hanger



Finishing: ardesia painted beech. 4 pieces package.

Handbags hanger



Finishing: ardesia painted beech. 1 piece package.

Pull out hook



Ardesia finishing. To be fixed in the middle of the shelves thickness (except glass shelves) or on the wooden sides of walk-in closets.

Bar for clothes hanger and bar for clothes hanger with hook

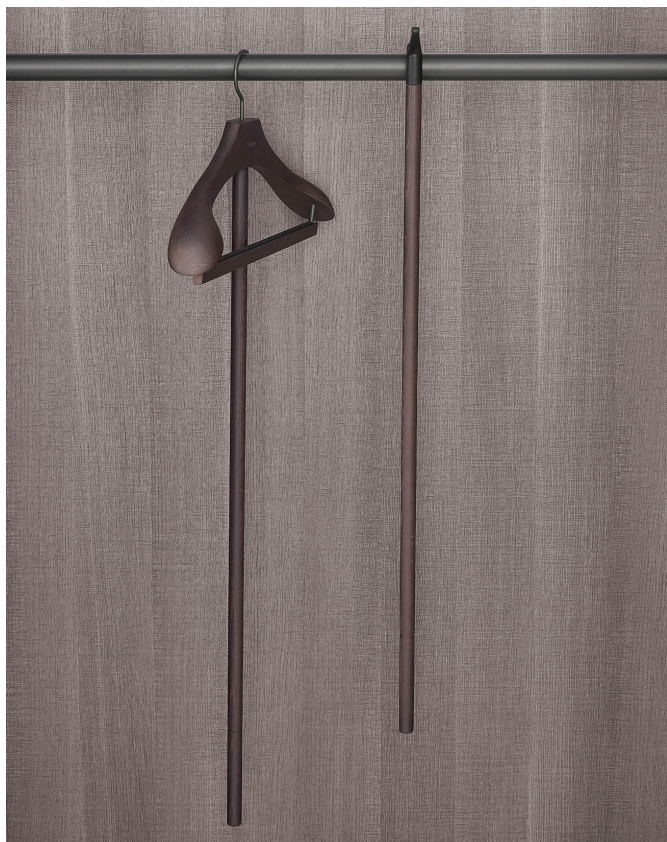

Finishing: ardesia painted beech. Bar for clothes hanger, 4 pieces package.
Bar for clothes hanger with hook, 1 piece package.

Ties hanger



Bar in ardesia finishing, for 28 ties. To be fixed behind leaf doors. Not to be used on Madison, Bangkok and Ocean doors. Depth 17".

Pull-out ties hanger

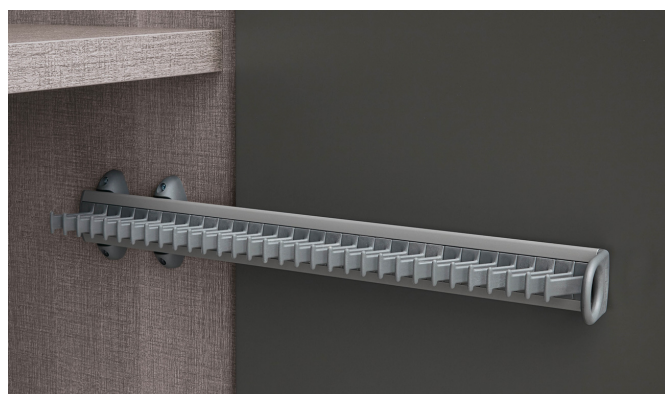

Bar in ardesia finishing, for 32 ties. To be fixed to wooden side. Depth 19 3/4".

Pull-out belts hanger

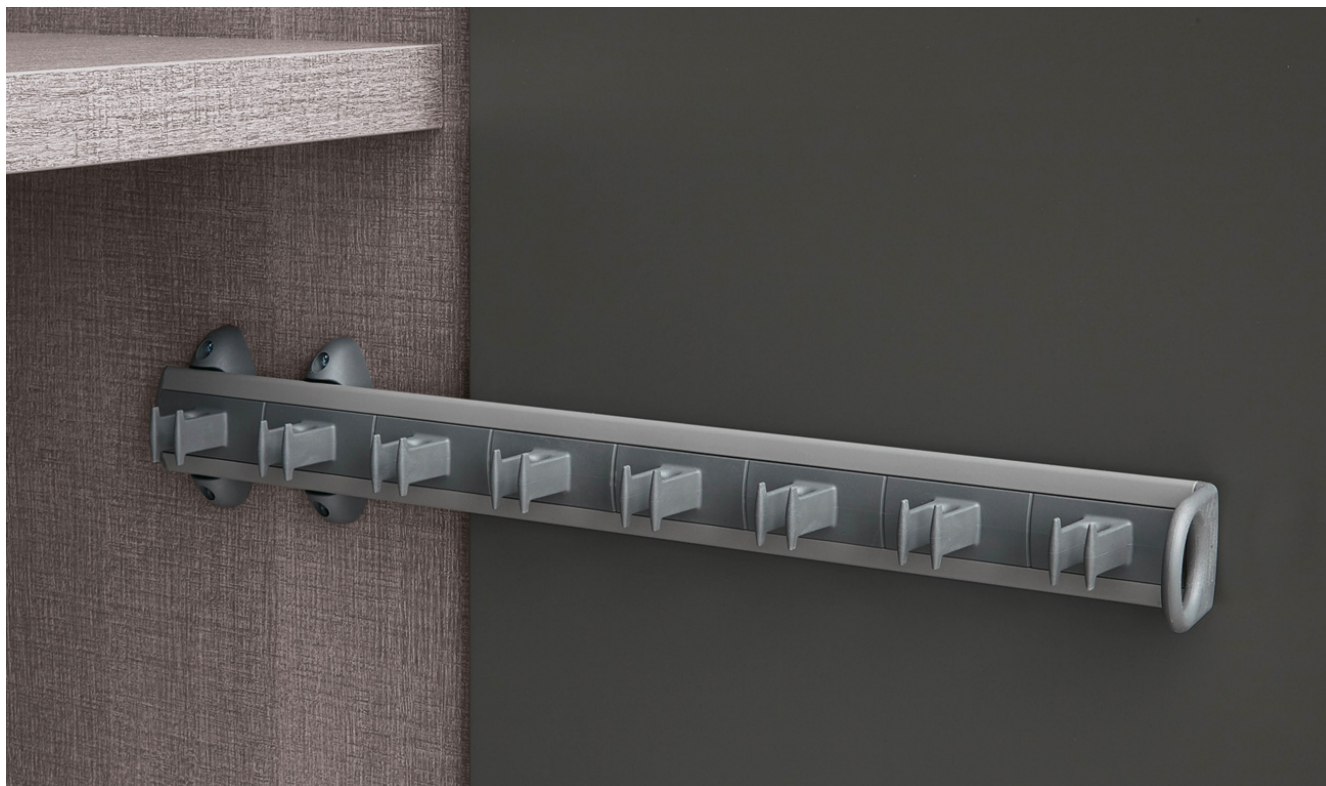

Bar in ardesia finishing, for 16 belts. To be fixed to wooden side. Depth 19 3/4".

Lighting system



Led lamps with warm temperature 3000°K, 110V or 220V complete with power supply and cables for connection. Available for all the shelf typologies and lengths, also for double end unit and corner unit. Customizations in width are possible. The power supplies are positioned on the top of the first unit on the left. The vertical electrified channel is needed for lighted shelves and for inclined shoe shelves. The vertical channel, in colour ardesia, is positioned on the right side panel. For wardrobes, a sensor positioned on the top allows the lighting by opening the doors.



The use of led lamps only for the top shelf does not need the vertical channel. Without vertical channel more shelves with led lamps cannot be added later.

Air sanitizer





In the finish aluminium mat painted ardesia or champagne, in the same length of the shelf (except w 14 3/4"). Positioned in the rear part of the shelf or a chest of drawers top and integrated in the electrification system of the wardrobe (vertical electrified channel), see page 86. The device is operated by a remote control and deactivated through a switch at the bottom. The sanitizer is available for all the shelf typologies of the system Senzafine. The device treats the air at three stages. At the first stage, the catalyzed filter, which can be regenerated and washable in the dishwasher, retains part of the bacteria present in the air that is moved by the fans in the device. At the second stage, the UVA led neutralizes what the filter has retained. At the third stage, bipolar ionization technology produces and injects millions of positive and negative ions into the wardrobe, which attack bacteria and odours, destroying them and sanitizing the contents inside the wardrobe.



To activate the sanitizer device and to select the programmes, 3, 6 or 9 hours. The same remote control can be used for one or more devices.

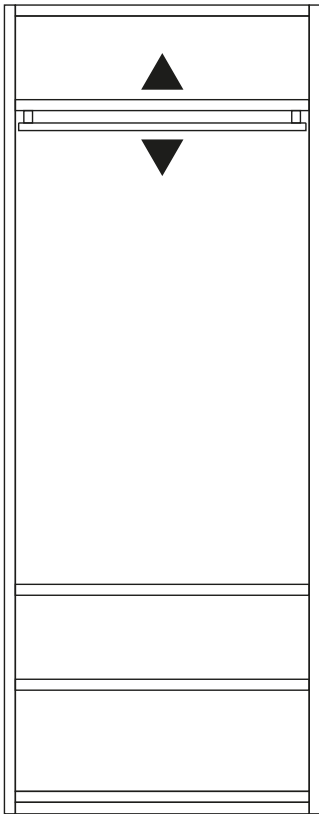

Shelf

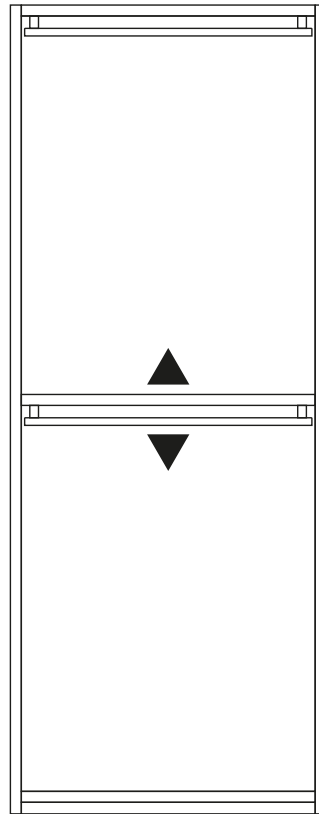

Shelf

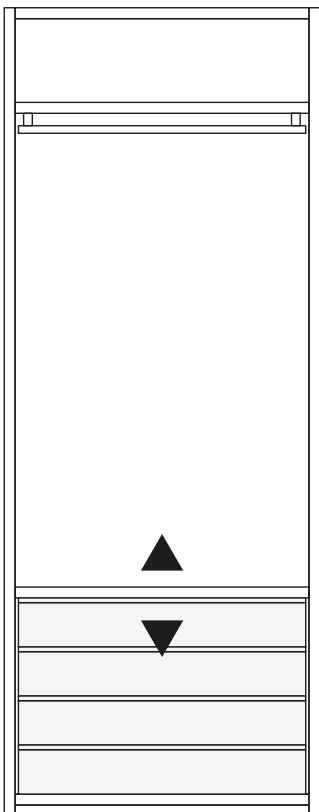

Freestanding
chest of drawers top

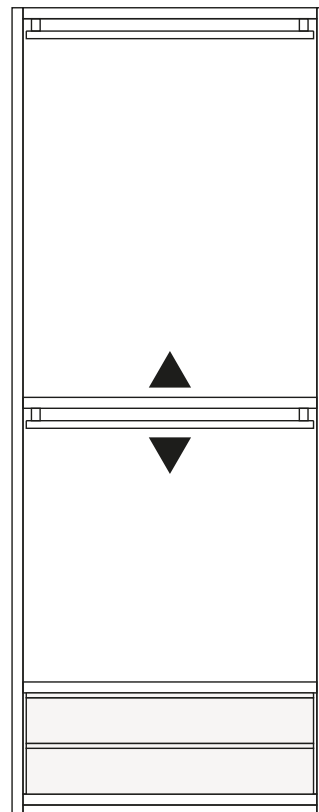

Shelf

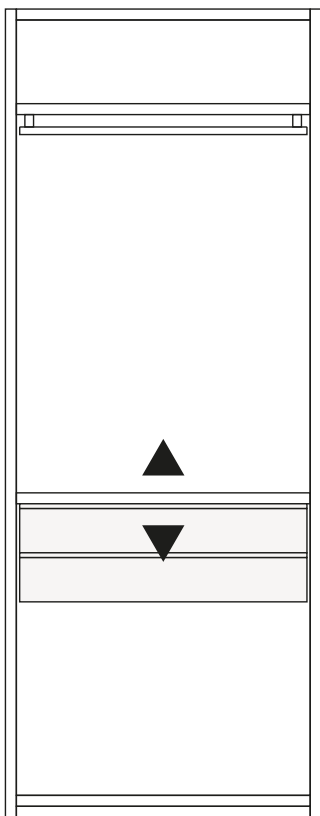

Hanging chest of drawers top

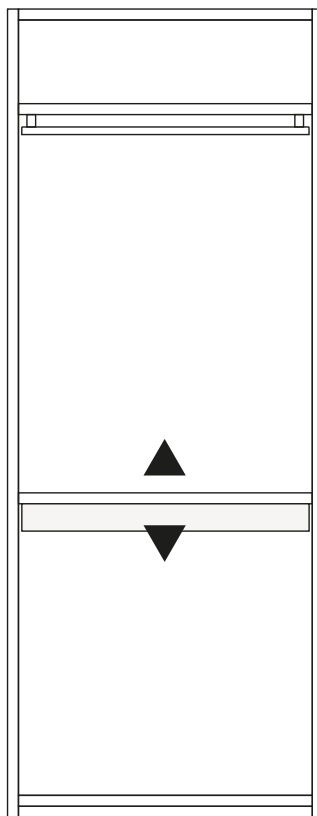

Trousers hanger top

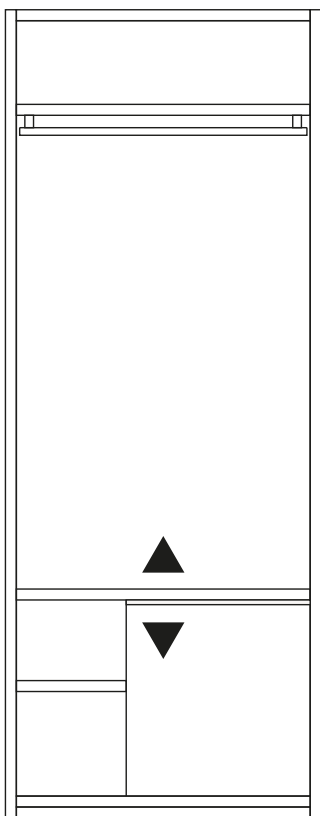

Laundry basket top

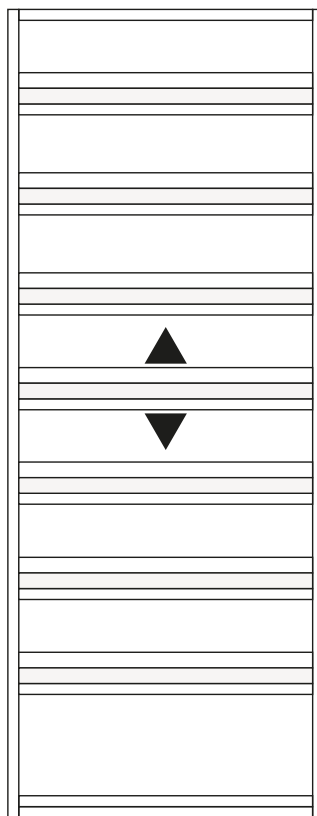

Shoes shelf

Drawers

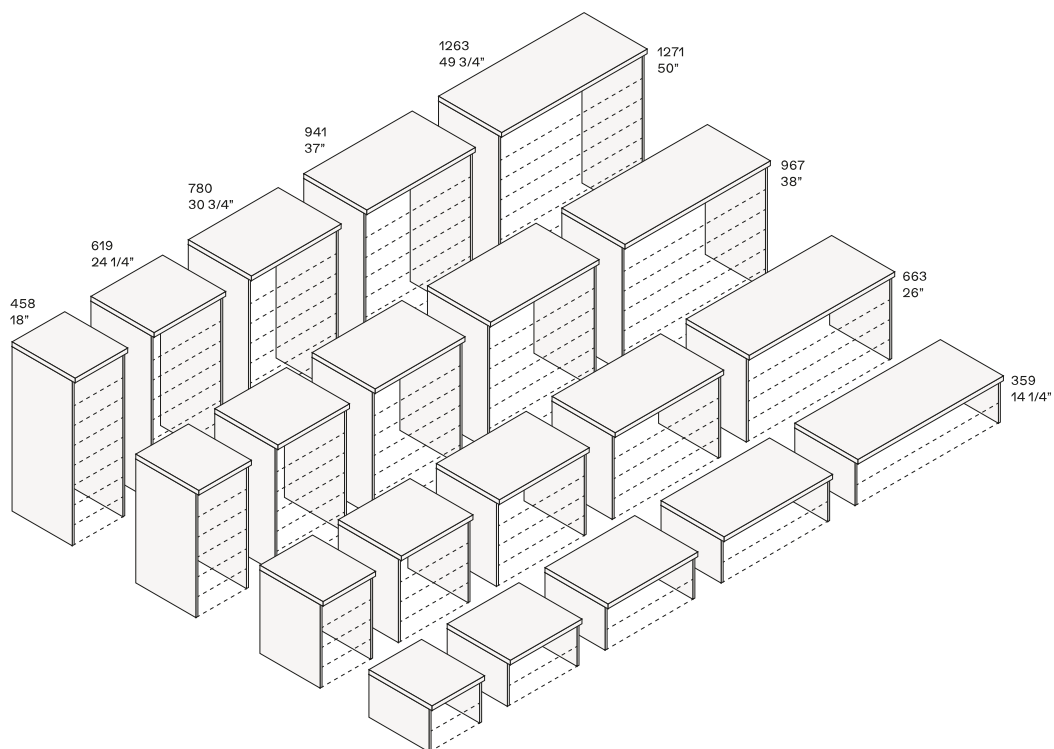

Available in 5 widths and 4 heights, depth 21 1/2". Can be equipped with drawers and trays. Cuts in width and depth are possible, except glass drawers in width and shoes tray in depth.

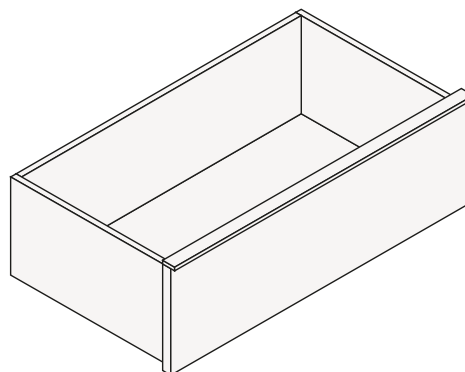
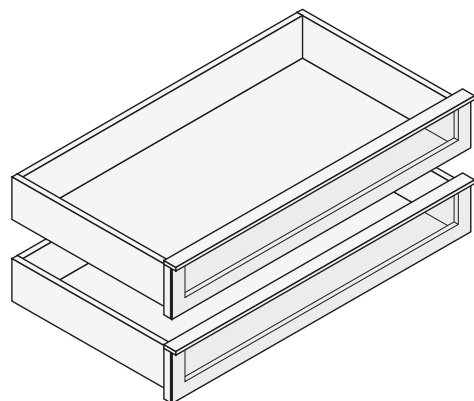
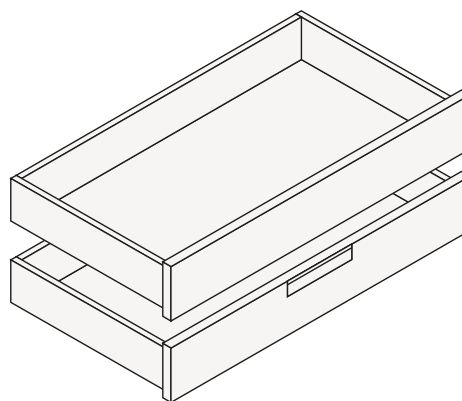
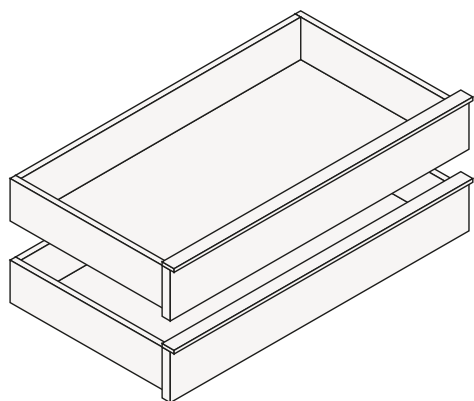

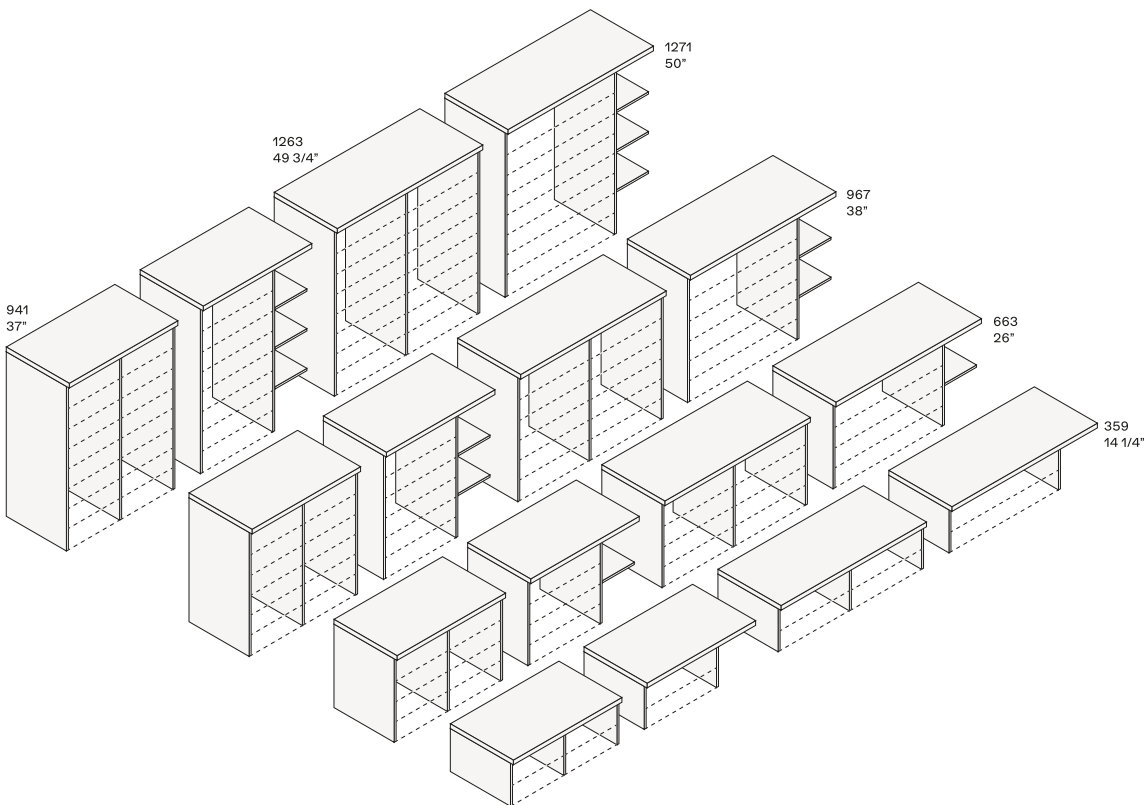
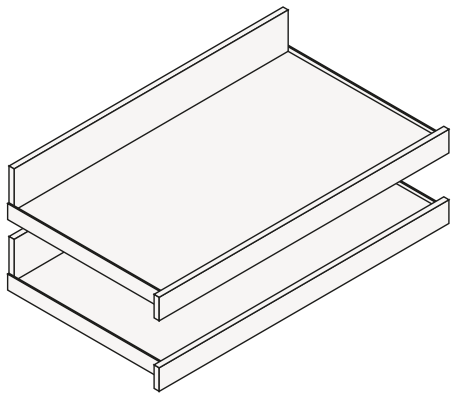
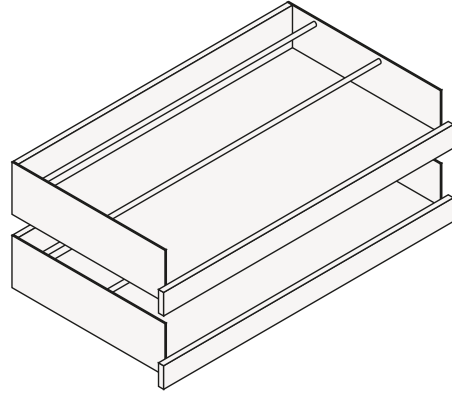
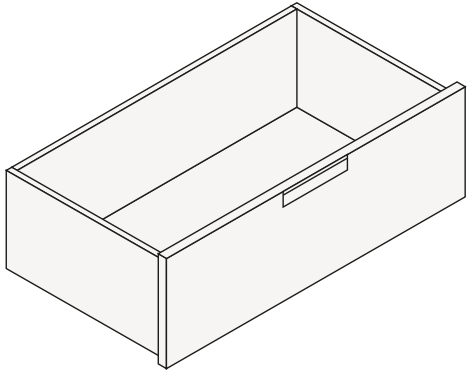

Drawer width 18"

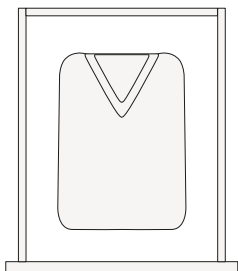

Drawer inner dimension w 13 3/4" d 17 1/4" h 4 1/2"-10 1/2".

Drawer or tray width 24 1/4"

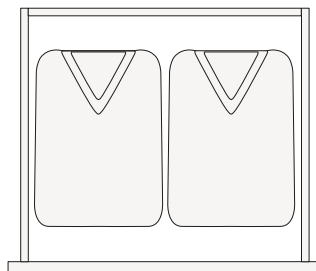

Drawer inner dimension w 18 1/2" d 17 1/4" h 4 1/2"-10 1/2". Tray inner dimension w 19 1/4" d 17 1/4" h 4 1/4".

Drawer or tray width 30 3/4"

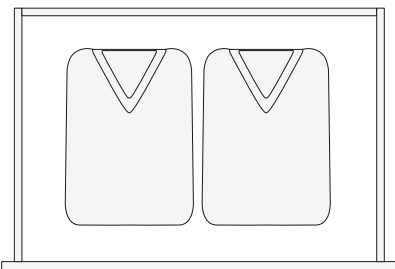

Drawer inner dimension w 25" d 17 1/4" h 4 1/2"-10 1/2". Tray inner dimension w 25 3/4" d 17 1/4" h 4 1/4".

Drawer or tray width 37"

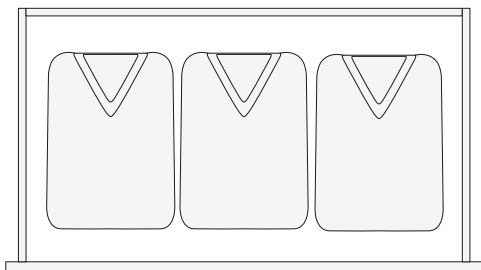

Drawer inner dimension w 31 1/4" d 17 1/4" h 4 1/2"-10 1/2". Tray inner dimension w 32" d 17 1/4" h 4 1/4".

Drawer or tray width 49 3/4"

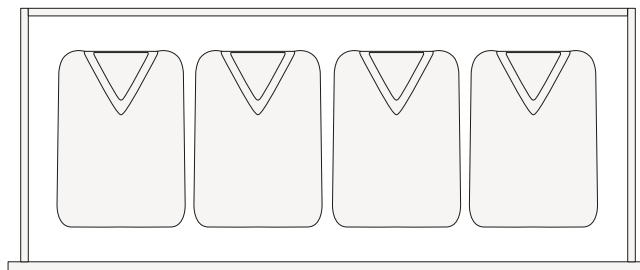

Drawer inner dimension w 44" d 17 1/4" h 4 1/2"-10 1/2". Tray inner dimension w 44 3/4" d 17 1/4" h 4 1/4".

Drawer or tray width 49 3/4"



Front in melamine 7 finishings or roller methacrylate 2 finishings. Mat ardesia or champagne painted Track handle. Drawer with full extraction glides and soft closing mechanism.

High wooden drawer Track handle



Front in melamine 7 finishings or roller methacrylate 2 finishings. Mat ardesia or champagne painted Track handle. Drawer with full extraction glides and soft closing mechanism.

Glass drawer with Track handle



Fumé reflecting glass front and perimeter edge ardesia or champagne. Mat ardesia or champagne painted Track handle. Drawer with full extraction glides and soft closing mechanism.

Wooden drawer Step handle



Front in melamine 7 finishings. Step handle mat ardesia and champagne painted or with bottom in 4 colours of techno cover. Drawer with full extraction glides and soft closing mechanism.

High wooden drawer Step handle



Front in melamine 7 finishings. Step handle mat ardesia and champagne painted or with bottom in 4 colours of techno cover. Drawer with full extraction glides and soft closing mechanism.

Track handle



Mat painted ardesia or mat painted champagne handle. For melamine, roller methacrylate and glass drawers.

Step handle



Mat painted ardesia or mat painted champagne built-in handle. Step handle is positioned in the front of the lower drawer, the upper drawer has a cut out which works as a non-visible handle. On request, we can mount handles in all the drawers. For wooden drawers, except drawer front in finish roller methacrylate.

Step techno cover handle



Mat painted ardesia built-in handle with inlay in techno cover 4 colours or mat painted champagne with inlay in techno cover 4 colours. For wooden drawers, except front in the finish roller methacrylate.

Tray



Tray in melamine 7 finishings with mat painted ardesia or champagne sides. Trays with full extraction glides and soft closing mechanism.

Shoes tray



Tray in melamine 7 finishings with mat ardesia or champagne painted round bars and sides. Trays with full extraction glides and soft closing mechanism.

Drawers interior



Wooden drawers and glass drawers interior in ardesia melamine.

Bottom in techno cover for drawers



Optional bottom in 4 techno cover colours. Not available for existing drawers because it is applied directly on wooden and glass drawers bottom.

Partition elements



In ardesia melamine, for drawers and trays. Not available for space width 18".

Trays interior



Interior in melamine 7 finishings, mat ardesia or champagne painted round bars and sides (for shoes tray only).

Bottom in techno leather for trays



Optional bottom in 4 techno cover colours. Not available for existing trays because it is applied directly on trays and shoes trays bottom.

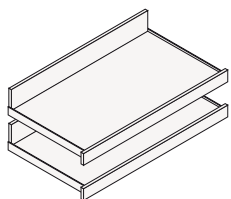
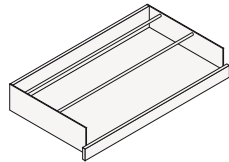
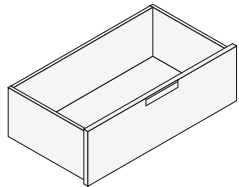
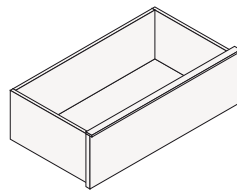
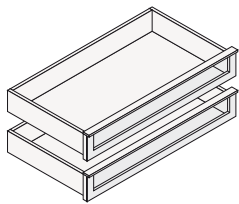
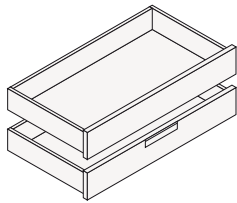
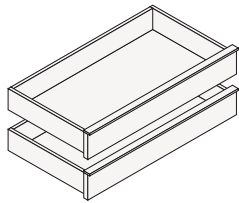
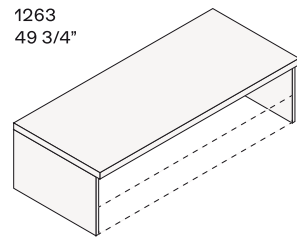
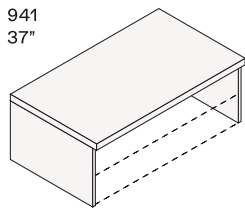
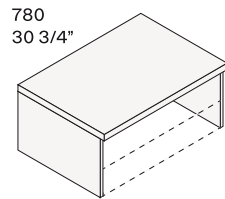
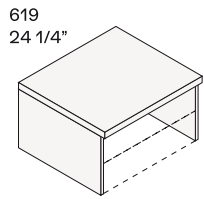
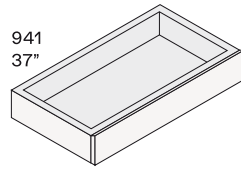
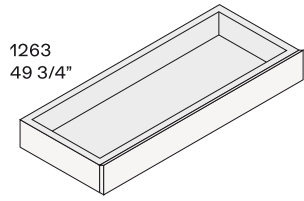

619
24 1/4"

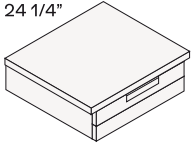

780
30 3/4"

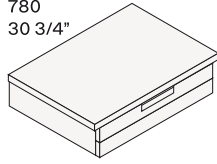

941
37"

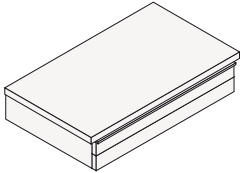
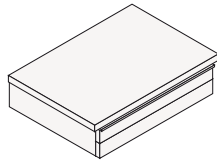
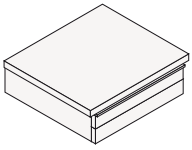
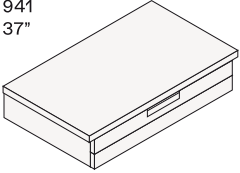

619
24 1/4"

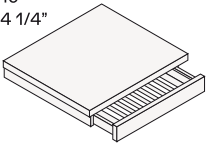

780
30 3/4"

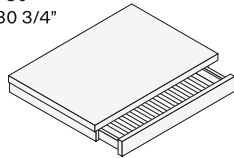

941
37"

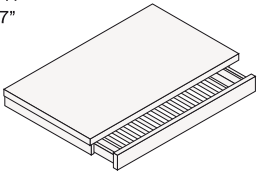

Man wrist watch tray w 11 1/4" d 5"

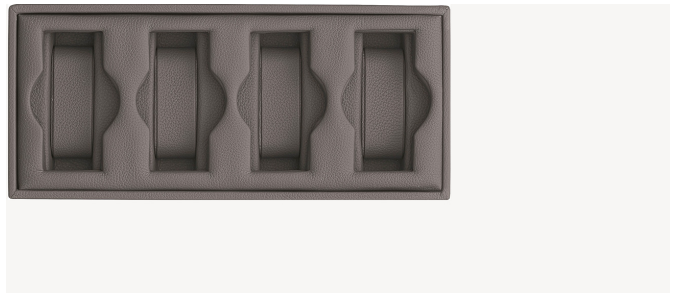

Woman wrist watch tray w 11 1/4" d 5"



Cufflink/ring tray w 16 3/4" d 5 1/4"



Earrings tray w 11 1/4" d 5"



Case with movable partition element w 11 1/4" d 5"

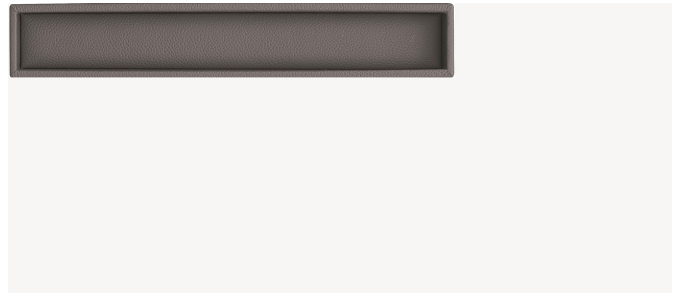

Case w 11 1/4" d 1 3/4"

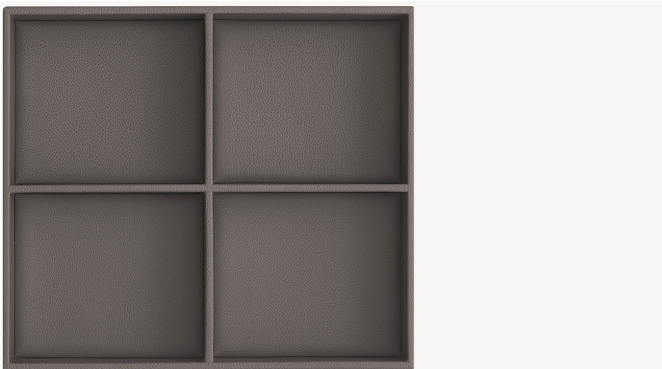

Double case w 11 1/4" d 10"



The accessories can be inserted into dresser valet.



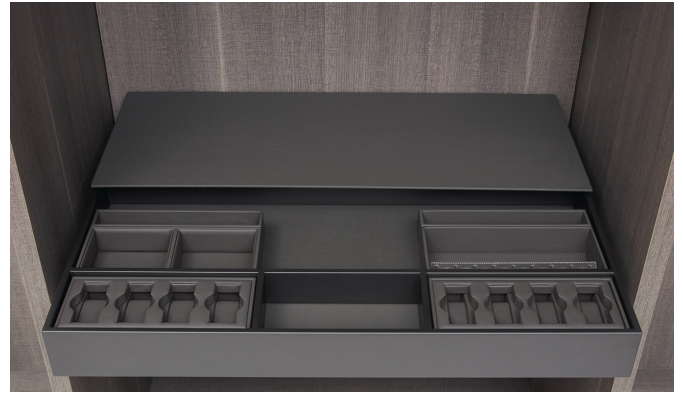

Laccato opaco ardesia o champagne con piano superiore e fondo in tecnocover 4 colori. Da utilizzare in appoggio su ripiani e cassettiere. Dimensioni mm: l 864 p 504 h 90.

Storage units

617
24 1/4"

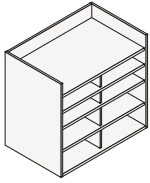

939
37"

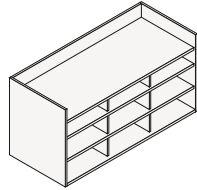
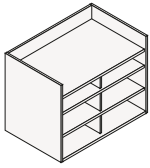
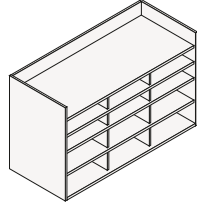

1261
49 3/4"

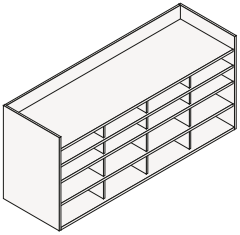

575
22 3/4"

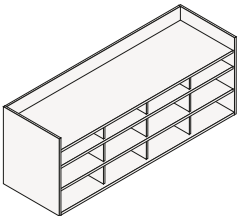

476
18 3/4"

Shirts storage



Storage unit in melamine in 7 finishings. To be used on shelves (except glass shelves) depth 15 3/4" or 21 1/2" or chests of drawers depth 21 1/2".

Shirts storage with shelves in techno cover



Storage unit in melamine in 7 finishings with upper shelf and inner shelves covered in techno cover 4 colours. To be used on shelves (except glass shelves) depth 15 3/4" or 21 1/2" or chests of drawers depth 21 1/2".

Optional drawers for shirts storage



Small drawers covered in fabric ardesia. Available in 2 heights, h 4" shirt drawers, h 2 1/2" jewellery drawers with inner partitions. They cannot be used in the lateral open compartments in case of doors. The small drawers cannot be used in the storage unit w 24 1/4".

617
24 1/4"

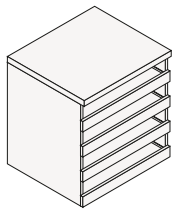

780
30 3/4"

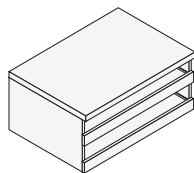
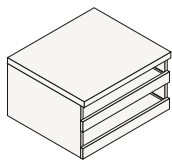
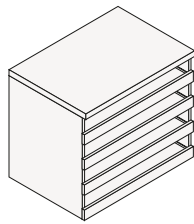

941
37"

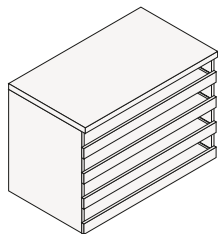

1263
49 3/4"

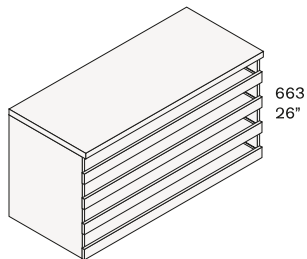

663
26"

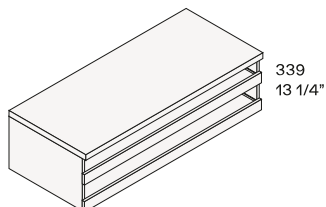
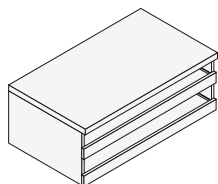

339
13 1/4"



Structure and trays in melamine in 7 finishings. Trays sides mat painted ardesia or champagne. To be used on shelves depth 21 1/2" in melamine or in melamine with aluminium front. The lateral sides of the shirt storage in combination with the frame side follow the same finish of the side. It cannot be used with glass sides.

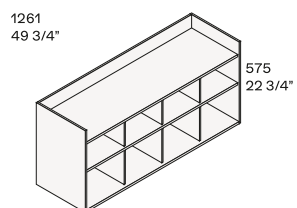
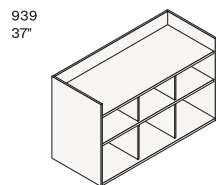
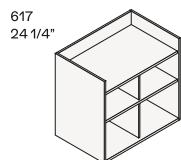



Storage unit in melamine in 7 finishings or with upper shelf and inner shelves covered in techno leather 4 colours. To be used on shelves (except glass shelves) depth 15 3/4" or 21 1/2" or chests of drawers depth 21 1/2".

939
37"

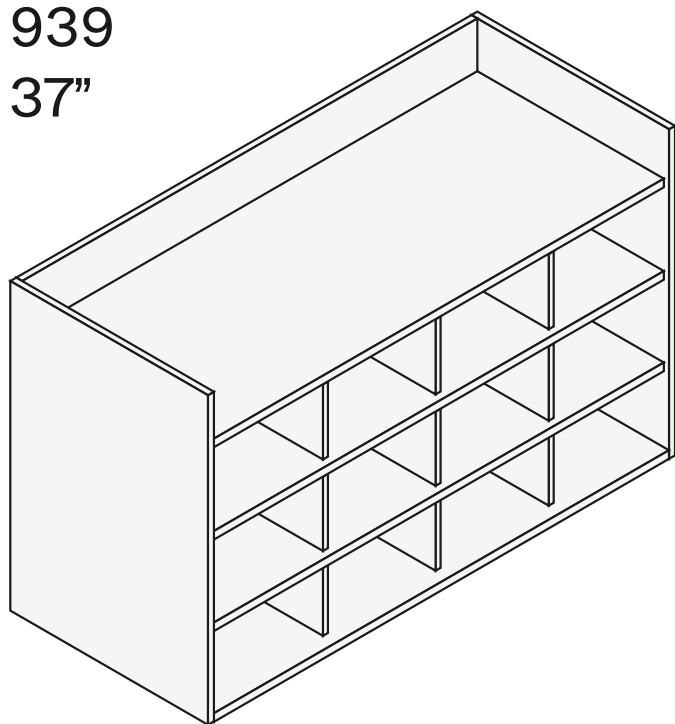

575
22 3/4"



Storage unit in melamine in 7 finishings or with upper shelf and inner shelves covered in techno leather 4 colours. Optional small drawers in fabric ardesia cannot be used in the lateral open compartments in case of doors. To be used on shelves (except glass shelves) depth 15 3/4" or 21 1/2" or chests of drawers depth 21 1/2".



Box covered in ardesia fabric also inside, with techno leather 01 elefante handle. 3 pieces package. Dimensions in: w 10 1/4" d 19" h 9 3/4" w 15 3/4" d 19" h 9 3/4".



In 7 melamine finishings. Optional removable laundry bag in fabric colour ardesia. Available handles Track mat painted ardesia or champagne and Step mat painted ardesia or champagne, or with bottom in 4 techno leather colours. No customizations are possible. Dimensions in: w 24 1/4" (1 basket), w 37" (1 basket and open compartment), w 49 3/4" (double baskets) d 19 1/2" h 26".

Shoes storage



Tray in 7 melamine finishings, bottom in melamine or in 4 techno leather colours. Tray with full extraction glides and soft closing mechanism. Not available with frame side or glass side. Customizations in width and depth are possible. Dimensions in: w 24 1/4"-37"-49 3/4" d 21" h 5 3/4".

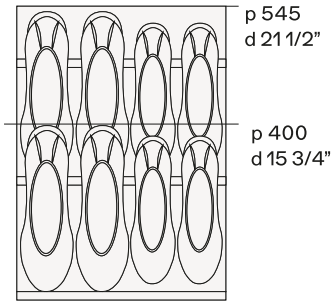

Width 14 3/4"

Available in two depths. Not available with frame side or glass side.

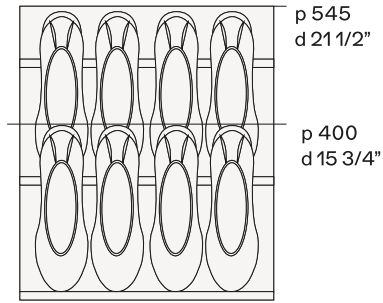

Width 18"

Available in two depths. Not available with frame side or glass side.

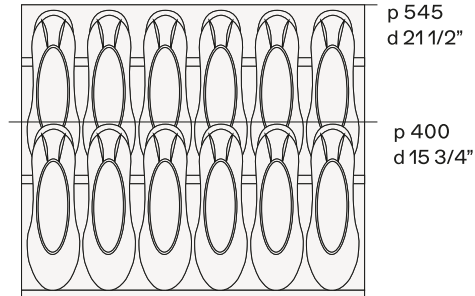

Width 24 1/4"

Available in two depths. Not available with frame side or glass side.

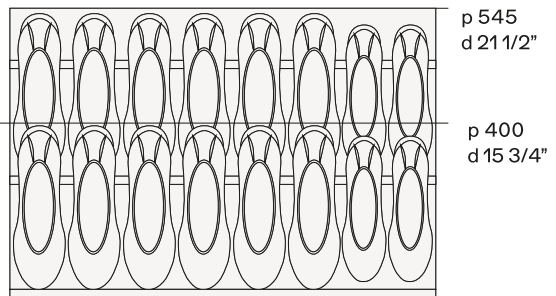

Width 30 3/4"

Available in two depths. Not available with frame side or glass side.

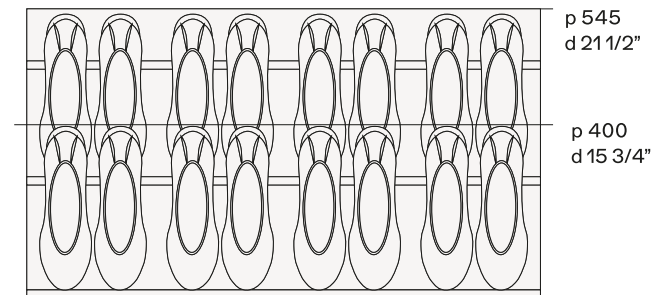

Width 37"

Available in two depths. Not available with frame side or glass side.

Safe

Combination safe



Grey metallic finish. Digital and key opening, backlit display, lined interior and internal courtesy light. On request supplied with opening frontal wooden door and all processings to assemble the safe into the unit. Dimensions in: w 15 1/4 d 13 3/4" h 9 1/2".

Mirror

Inner mirror



White mirror 4000. To be fixed behind leaf door. Not to be used on Ego, Fitted or Bangkok doors and on doors width 15 3/4". Customizations in width are possible. Dimensions in: w 14 1/4" d 1/4" h 70 3/4".

HANDLES



Metal knob
Finish: matt slate or champagne painted.
Dimensions mm: l 10 p 22 h 30.

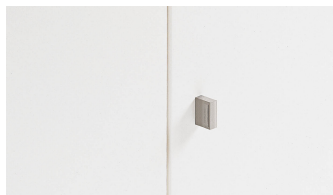

Metal key
Finish: matt slate or champagne painted. Complete with cariglione.
Diversified mapping on request.
Dimensions mm: l 10 p 22 h 30.



Twin
Finishing: matt slate and champagne painted or matt lacquered colors. For hinged column with double door, corner excluded, solution with two handles is recommended.
Dimensions mm: l 240 p 20 h 20.



Break
Finish: matt slate or champagne painted, matt white 01, hemp 35 or ice 60 lacquered. Can also be used vertically.
Dimensions mm: l 164 p 25 h 40.



Finishing: matt slate or champagne lacquered, matt lacquered colors or glossy lacquered colors.
Dimensions mm: l 25 h 160.



Finishing: matt slate or champagne lacquered, matt lacquered colors or glossy lacquered colors.
Dimensions mm: l 25 h 160.



Plate
Finishing: matt slate and champagne painted or matt lacquered colors. Can also be used horizontally.
Dimensions mm: l 42 p 15 h 180.



Havana
Finish: matt slate or champagne painted. For hinged column with double door, corner excluded, solution with two handles is recommended.
Dimensions mm: l 90 p 25 h 122.



Finish: matt slate or champagne painted. For hinged column with double door, corner excluded, solution with two handles is recommended.
Dimensions mm: l 90 p 25 h 122.



Cover
Finish: matt slate or champagne painted. For hinged column with double door, corner excluded, solution with two handles is recommended.
Dimensions mm: l 30 p 20 h 190.



Finish: 4-color tecnocover and matt slate or champagne varnish. For hinged column with double door, corner excluded, solution with two handles is recommended.
Dimensions mm: l 30 p 20 h 190.

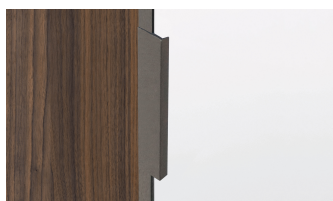

Finishing: matt slate and champagne painted or matt lacquered colors.
Dimensions mm: l 12 p 15 h 190.

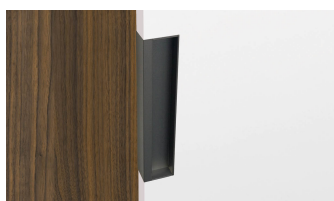

Gap
Finishing: matt slate and champagne painted or matt lacquered colors. It is not possible to have a double handle on the column with double hinged doors.
Dimensions mm: l 41 p 25 h 200.

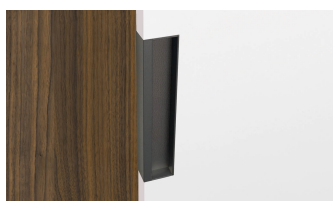

Finish: matt slate or champagne painted with bottom coated in 4-color Grain tecnocover. It is not possible to have a double handle on the column with double hinged doors.



Finishing: matt slate and champagne painted or matt lacquered colors.
Dimensions mm: l 8 p 30 h 995.